

CONTACTOR FOR RAIL, AC-3, 5.5KW 400V, DC 24V, 0.7...1.25\*US, W. SUPPRESSOR DIODE INTEGRATED, 3-POLE, SIZE S00, SPRING-LOADED CONNECTION SPRING-LOADED TERMINAL

Figure similar

product brand name		SIRIUS
Product designation		Coupling relay

General technical data:

<b>Insulation voltage</b>		
<ul style="list-style-type: none"> <li>Rated value</li> </ul>	V	690
<b>Degree of pollution</b>		3
<b>Surge voltage resistance Rated value</b>	kV	6
<b>Mechanical service life (switching cycles)</b>		
<ul style="list-style-type: none"> <li>of the contactor typical</li> </ul>		30 000 000
<ul style="list-style-type: none"> <li>of the contactor with added electronics-compatible auxiliary switch block typical</li> </ul>		5 000 000
<ul style="list-style-type: none"> <li>of the contactor with added auxiliary switch block typical</li> </ul>		10 000 000
<b>Thermal short-time current restricted to 10 s</b>	A	90
<b>Protection class IP</b>		
<ul style="list-style-type: none"> <li>on the front</li> </ul>		IP20
<ul style="list-style-type: none"> <li>of the terminal</li> </ul>		IP20
<b>Equipment marking</b>		
<ul style="list-style-type: none"> <li>acc. to DIN EN 61346-2</li> </ul>		Q
<ul style="list-style-type: none"> <li>acc. to DIN EN 81346-2</li> </ul>		Q

Main circuit:

<b>Number of poles for main current circuit</b>		3
<b>Number of NC contacts for main contacts</b>		0
<b>Number of NO contacts for main contacts</b>		3
<b>Operating voltage</b>		

• at AC-3 Rated value maximum	V	690
<b>Operating current</b>		
• at AC-1		
— at 400 V at ambient temperature 40 °C Rated value	A	22
— up to 690 V at ambient temperature 40 °C Rated value	A	22
— up to 690 V at ambient temperature 60 °C Rated value	A	20
• at AC-2 at 400 V Rated value	A	12
• at AC-3		
— at 400 V Rated value	A	12
— at 500 V Rated value	A	9.2
— at 690 V Rated value	A	6.7
• at AC-4 at 400 V Rated value	A	8.5
<b>Operating current with 1 current path</b>		
• at DC-1		
— at 24 V Rated value	A	20
— at 110 V Rated value	A	2.1
— at 220 V Rated value	A	0.8
— at 440 V Rated value	A	0.6
— at 600 V Rated value	A	0.6
• at DC-3 at DC-5		
— at 24 V Rated value	A	20
— at 110 V Rated value	A	0.1
<b>Operating current with 2 current paths in series</b>		
• at DC-1		
— at 24 V Rated value	A	20
— at 110 V Rated value	A	12
— at 220 V Rated value	A	1.6
— at 440 V Rated value	A	0.8
— at 600 V Rated value	A	0.7
• at DC-3 at DC-5		
— at 110 V Rated value	A	0.35
— at 24 V Rated value	A	20
<b>Operating current with 3 current paths in series</b>		
• at DC-1		
— at 24 V Rated value	A	20
— at 110 V Rated value	A	20
— at 220 V Rated value	A	20
— at 440 V Rated value	A	1.3
— at 600 V Rated value	A	1

<ul style="list-style-type: none"> <li>• at DC-3 at DC-5               <ul style="list-style-type: none"> <li>— at 110 V Rated value</li> <li>— at 220 V Rated value</li> <li>— at 24 V Rated value</li> <li>— at 440 V Rated value</li> <li>— at 600 V Rated value</li> </ul> </li> </ul>	A	20
	A	1.5
	A	20
	A	0.2
	A	0.2
<b>Operating power</b>		
<ul style="list-style-type: none"> <li>• at AC-1 at 400 V Rated value</li> <li>• at AC-2 at 400 V Rated value</li> <li>• at AC-4 at 400 V Rated value</li> </ul>	kW	13
	kW	5.5
	kW	4
<b>Operating power</b>		
<ul style="list-style-type: none"> <li>• at AC-1               <ul style="list-style-type: none"> <li>— at 230 V at 60 °C Rated value</li> <li>— at 230 V Rated value</li> <li>— at 400 V at 60 °C Rated value</li> <li>— at 690 V at 60 °C Rated value</li> <li>— at 690 V Rated value</li> </ul> </li> <li>• at AC-3               <ul style="list-style-type: none"> <li>— at 230 V Rated value</li> <li>— at 400 V Rated value</li> <li>— at 690 V Rated value</li> </ul> </li> </ul>	kW	7.5
	kW	7.5
	kW	13
	kW	22
	kW	22
	kW	3
	kW	5.5
	kW	5.5
<b>Operating power for <math>\geq 200000</math> operating cycles at AC-4</b>		
<ul style="list-style-type: none"> <li>• at 400 V Rated value</li> <li>• at 690 V Rated value</li> </ul>	kW	2
	kW	2.5
<b>Operating frequency</b>		
<ul style="list-style-type: none"> <li>• at AC-3 maximum</li> </ul>	1/h	750

#### Control circuit/ Control:

<b>Type of voltage of the control supply voltage</b>		DC
<b>Control supply voltage for DC</b>		
<ul style="list-style-type: none"> <li>• Rated value</li> </ul>	V	24
<b>Operating range factor control supply voltage rated value of the magnet coil for DC</b>		0.7 ... 1.25
<b>Design of the surge suppressor</b>		with suppressor diode
<b>Closing power of the magnet coil for DC</b>	W	2.8
<b>Holding power of the magnet coil for DC</b>	W	2.8

#### Auxiliary circuit:

<b>Number of NC contacts</b>		
<ul style="list-style-type: none"> <li>• for auxiliary contacts               <ul style="list-style-type: none"> <li>— instantaneous contact</li> </ul> </li> </ul>		1
<b>Number of NO contacts</b>		

<ul style="list-style-type: none"> <li>• for auxiliary contacts <ul style="list-style-type: none"> <li>— instantaneous contact</li> </ul> </li> </ul>		0
<b>Product expansion Auxiliary switch</b>		No
<b>Operating current at AC-15</b>		
<ul style="list-style-type: none"> <li>• at 230 V Rated value</li> </ul>	A	10
<ul style="list-style-type: none"> <li>• at 400 V Rated value</li> </ul>	A	3
<ul style="list-style-type: none"> <li>• at 690 V Rated value</li> </ul>	A	1
<b>Operating current</b>		
<ul style="list-style-type: none"> <li>• at DC-12 at 125 V Rated value</li> </ul>	A	2
<ul style="list-style-type: none"> <li>• at DC-12 at 220 V Rated value</li> </ul>	A	1
<ul style="list-style-type: none"> <li>• at DC-12 at 600 V Rated value</li> </ul>	A	0.15
<ul style="list-style-type: none"> <li>• at DC-13 at 125 V Rated value</li> </ul>	A	0.9
<ul style="list-style-type: none"> <li>• at DC-13 at 220 V Rated value</li> </ul>	A	0.3
<ul style="list-style-type: none"> <li>• at DC-13 at 600 V Rated value</li> </ul>	A	0.1
<b>Operating current</b>		
<ul style="list-style-type: none"> <li>• at DC-12 <ul style="list-style-type: none"> <li>— at 60 V Rated value</li> <li>— at 110 V Rated value</li> </ul> </li> </ul>	A	6
	A	3
<ul style="list-style-type: none"> <li>• at DC-13 <ul style="list-style-type: none"> <li>— at 24 V Rated value</li> <li>— at 60 V Rated value</li> <li>— at 110 V Rated value</li> </ul> </li> </ul>	A	10
	A	2
	A	1
<b>Contact reliability of the auxiliary contacts</b>		1 faulty switching per 100 million (17 V, 1 mA)

#### UL/CSA ratings:

<b>Full-load current (FLA) for three-phase AC motor</b>		
<ul style="list-style-type: none"> <li>• at 480 V Rated value</li> </ul>	A	11
<ul style="list-style-type: none"> <li>• at 600 V Rated value</li> </ul>	A	11
<b>yielded mechanical performance [hp]</b>		
<ul style="list-style-type: none"> <li>• for single-phase AC motor at 110/120 V Rated value</li> </ul>	metric hp	0.5
<ul style="list-style-type: none"> <li>• for single-phase AC motor at 230 V Rated value</li> </ul>	metric hp	2
<ul style="list-style-type: none"> <li>• for three-phase AC motor at 200/208 V Rated value</li> </ul>	metric hp	3
<ul style="list-style-type: none"> <li>• for three-phase AC motor at 220/230 V Rated value</li> </ul>	metric hp	3
<ul style="list-style-type: none"> <li>• for three-phase AC motor at 460/480 V Rated value</li> </ul>	metric hp	7.5
<ul style="list-style-type: none"> <li>• for three-phase AC motor at 575/600 V Rated value</li> </ul>	metric hp	10
<b>Contact rating of the auxiliary contacts acc. to UL</b>		A600 / Q600

#### Short-circuit:

<b>Design of the fuse link</b>		
<ul style="list-style-type: none"> <li>• for short-circuit protection of the main circuit <ul style="list-style-type: none"> <li>— with type of assignment 1 required</li> <li>— with type of assignment 2 required</li> </ul> </li> <li>• for short-circuit protection of the auxiliary switch required</li> </ul>		gL/gG LV HRC 3NA, DIAZED 5SB, NEOZED 5SE: 35 A  gL/gG LV HRC 3NA, DIAZED 5SB, NEOZED 5SE: 20 A  fuse gL/gG: 10 A

### Installation/ mounting/ dimensions:

<b>mounting position</b>		+/-180° rotation possible on vertical mounting surface; can be tilted forward and backward by +/- 22.5° on vertical mounting surface
<b>Mounting type</b>		screw and snap-on mounting onto 35 mm standard mounting rail according to DIN EN 50022
<ul style="list-style-type: none"> <li>• Side-by-side mounting</li> </ul>		Yes
<b>Height</b>	mm	57.5
<b>Width</b>	mm	45
<b>Depth</b>	mm	117
<b>Required spacing</b>		
<ul style="list-style-type: none"> <li>• with side-by-side mounting <ul style="list-style-type: none"> <li>— forwards</li> <li>— Backwards</li> <li>— upwards</li> <li>— downwards</li> <li>— at the side</li> </ul> </li> <li>• for grounded parts <ul style="list-style-type: none"> <li>— forwards</li> <li>— Backwards</li> <li>— upwards</li> <li>— at the side</li> <li>— downwards</li> </ul> </li> <li>• for live parts <ul style="list-style-type: none"> <li>— forwards</li> <li>— Backwards</li> <li>— upwards</li> <li>— downwards</li> <li>— at the side</li> </ul> </li> </ul>	mm	0 0 0 0 0  0 0 0 6 0  0 0 0 0 6

### Connections/ Terminals:

<b>Type of electrical connection</b>		
<ul style="list-style-type: none"> <li>• for main current circuit</li> <li>• for auxiliary and control current circuit</li> </ul>		ring cable connection ring cable connection

### Safety related data:

B10 value with high demand rate acc. to SN 31920		1 000 000
Proportion of dangerous failures		
• with low demand rate acc. to SN 31920	%	40
• with high demand rate acc. to SN 31920	%	73
Failure rate [FIT] with low demand rate acc. to SN 31920	FIT	100
Product function Mirror contact acc. to IEC 60947-4-1		Yes
T1 value for proof test interval or service life acc. to IEC 61508	y	20
Protection against electrical shock		finger-safe





#### Mechanical data:





Size of contactor		S00
-------------------	--	-----





#### Ambient conditions:

Installation altitude at height above sea level maximum	m	2 000
Ambient temperature		
• during operation	°C	-40 ... +70
• during operation Note		Railway application: See catalog for rated conditions
• during storage	°C	-55 ... +80

#### Certificates/ approvals:

General Product Approval	Functional Safety/Safety of Machinery	Declaration of Conformity
 CCC	 CSA	 EAC
 UL	<a href="#">Type Examination</a>	 EG-Konf.

Test Certificates	Shipping Approval
<a href="#">Special Test Certificate</a>	<a href="#">Type Test Certificates/Test Report</a>
 ABS	 BUREAU VERITAS
 DNV	 GL

Shipping Approval	other
 LRS	 PRR
 RINA	 RMRS
 VDE	<a href="#">Environmental Confirmations</a>

#### Further information

**Information- and Downloadcenter (Catalogs, Brochures,...)**

<http://www.siemens.com/industrial-controls/catalogs>

**Industry Mall (Online ordering system)**

<http://www.siemens.com/industrymall>

**Cax online generator**

<http://support.automation.siemens.com/WW/CAXorder/default.aspx?lang=en&mfb=3RT20174KB420LA0>

**Service&Support (Manuals, Certificates, Characteristics, FAQs,...)**

<http://support.automation.siemens.com/WW/view/en/3RT20174KB420LA0/all>

**Image database (product images, 2D dimension drawings, 3D models, device circuit diagrams, EPLAN macros, ...)**

[http://www.automation.siemens.com/bilddb/cax\\_de.aspx?mfb=3RT20174KB420LA0&lang=en](http://www.automation.siemens.com/bilddb/cax_de.aspx?mfb=3RT20174KB420LA0&lang=en)

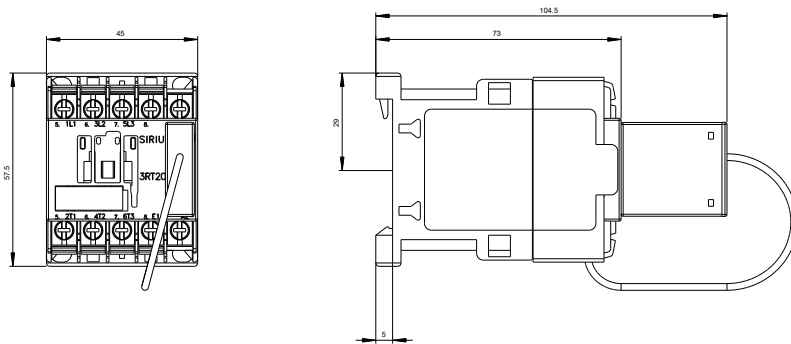

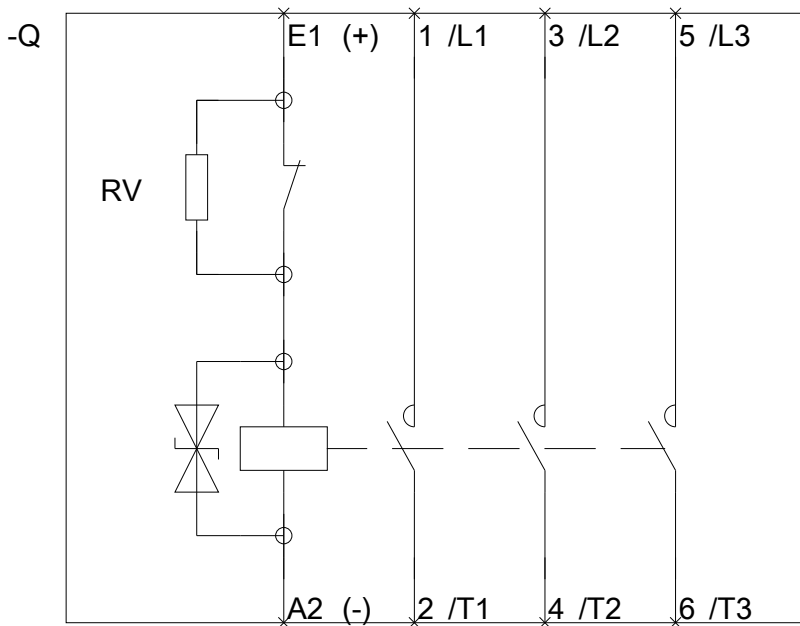
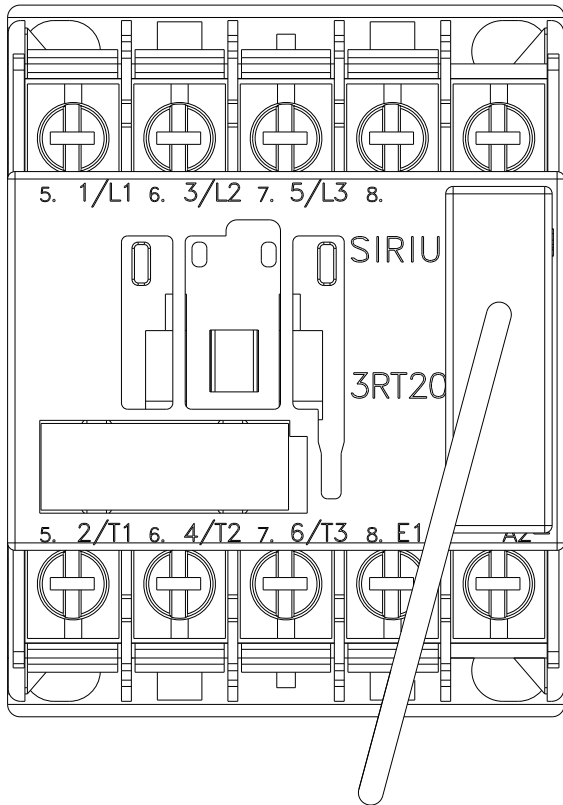

last modified:

11.03.2015