

Clamps · DIN 6315 B forked

23150.0015

Product Description

This clamp (clamping claw) according to DIN 6314 B is forked and is mainly used in mechanical clamping technology for clamping workpieces.

Material

- Heat-treated steel, varnished



Drawing

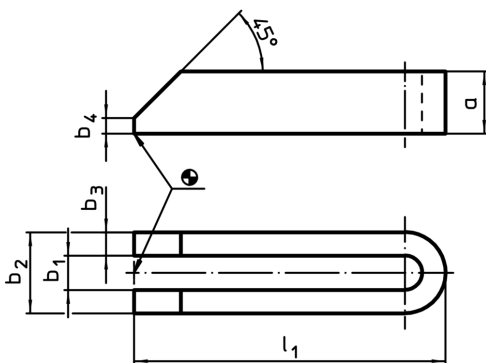

Order information

Nominal dimension b ₁ [mm]	Dimensions					For screws		Art. No.	
	l ₁	a	b ₂	b ₃	b ₄	[mm]	[inch]		
14	160	25	38	12	6	M12, M14	1/2	715	23150.0015

Compliance

RoHS compliant

Compliant according to Directive 2011/65/EU and Directive 2015/863

Does not contain SVHC substances

No SVHC substances with more than 0.1% w/w contained - SVHC list [REACH] as of 10.06.2022

Does not contain Proposition 65 substances

No Proposition 65 substances included

<https://www.P65Warnings.ca.gov/>

Free from Conflict Minerals

This product does not contain any substances designated as "conflict minerals" such as tantalum, tin, gold or tungsten from the Democratic Republic of Congo or adjacent countries.