

## Interlock Switches with Solenoid

# HS5L



### Compact design with 2- and 4-contacts



- See website for details on approvals and standards.
- KOHSA (S mark) approved only on some models.

#### Additional Marking to indicate Locking Monitoring



This new international marking for lock monitoring is described in clause 9.2.1 of ISO14119 and is used to satisfy the requirements shown below.

5.7.1 General requirements

5.7.2.2 Locking monitoring

The lock monitor circuit (contacts) with this marking can monitor both the status of protective door and locking function. (locking monitor contact [circuits] opens when the protective door is closed and locked)

Both spring lock and solenoid lock models of HS5L have marking for lock monitoring. Note that solenoid lock model can be used in applications where lock for safety purpose is found unnecessary after a risk assessment, e.g. locking is needed for purposes such as in production process.

|   | Features  | Page         |
|---|-----------|--------------|
|  | 2-Contact | <b>E-033</b> |
|  | 4-Contact | <b>E-036</b> |

### Compact Design

Size is reduced by 13% from conventional models.\*

Mounts on small doors and aluminum frames of machines.

Compact design with 2- and 4-contacts reduce installation space.

Greater flexibility in machine design.

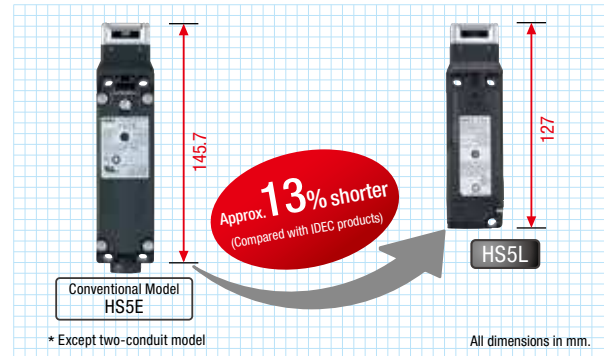

### Compact with powerful 1400N locking strength

The size is greatly reduced while achieving the same 1400N (Fzh) locking strength as the conventional HS5E series. (GS-ET-19)

### Gold-plated contacts suitable for small loads. Rear unlocking button

Door lock can be unlocked inside the barrier by a worker left inside a hazardous area.



### The head orientation can be rotated, allowing 8 different entries. Angle Adjustable Actuator (vertical/horizontal) with Plate

A new addition to angle adjustable actuator. Retention force of 1400N.



### Spring loaded actuator

IDEC patented spring loaded actuator locks the door safely when the door bounces. When the actuator is fully inserted (door closed completely), the door can tolerate a space of up to 16mm.



Patent acquired

\* Accessory exclusive for HS5L.

### Spring clamp terminals

Spring clamp terminals offer excellent vibration resistance, preventing wires from loosening. No need for additional tightening.

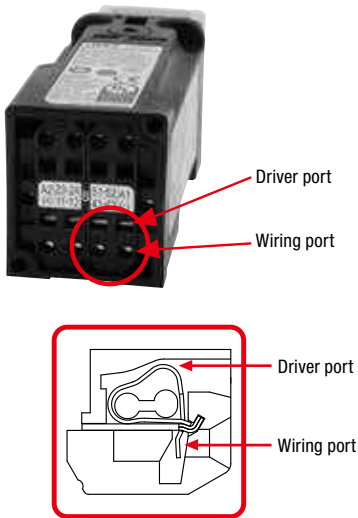

### Two-conduit Model

Cable can be connected to the right, left, or bottom (for straight cable orientation) of the terminal cover. Possible to use long marking tubes with the wiring cables.

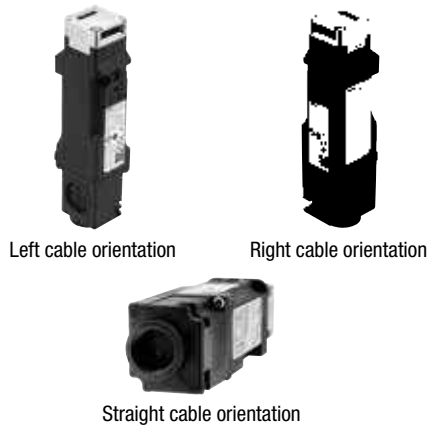

### Energy saving!

Solenoid energy consumption: 200mA  
Reduced by 25% from conventional HS5E series.

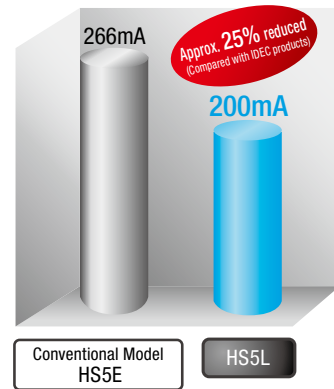

### Head Removal Detection Circuitry

Head removal detection circuitry is employed in the HS5L. With this innovative function, the monitor circuit (41-42) turns off when the head is removed from the switch, such as when removing the head to change the head direction (applicable with the HS5L spring lock models). For example, for circuit codes: VB, VD and DD, which have two or more lock monitor circuits installed, removing the head results in disparity (41-42: OFF, 51-52: ON). This disparity is detected by the head removal detection function.

#### • HS5L-VD44M-G (Lock monitor circuit)

|                            | Actuator unlocked | Actuator locked | Head removed |
|----------------------------|-------------------|-----------------|--------------|
|                            |                   |                 |              |
| Lock monitor circuit 41-42 | OFF               | ON              | OFF          |
| Lock monitor circuit 51-52 | OFF               | ON              | ON           |

Head removal detection function Monitor circuit (41-42)

Disparity

Note: Head removal detection function is not a direct opening action mechanism.

### Spring lock and Solenoid lock models available

#### Spring Lock

- Automatically locks the actuator without power applied to the solenoid.
- After the machine stops, unlocking is completed by the solenoid, providing high safety features.
- Manual unlocking is possible in the event of power failure or maintenance using a manual unlocking key.
- Head removal detection circuitry (spring lock models only).

#### Solenoid Lock

- The actuator is locked when energized.
- The actuator is unlocked when de-energized.
- Flexible locking function can be achieved, for an application where locking is not required and sudden stopping of a machine must be prevented.

- APEM
- Switches & Pilot Lights
- Control Boxes
- Emergency Stop Switches
- Enabling Switches
- Safety Products
- Explosion Proof
- Terminal Blocks
- Relays & Sockets
- Circuit Protectors
- Power Supplies
- LED Illumination
- Controllers
- Operator Interfaces
- Sensors
- AUTO-ID

- Interlock Switches
- Non-contact Interlock Switches
- Safety Laser Scanners
- Safety Light Curtains
- Safety Modules

- HS6B
- HS6E
- HS5D
- HS5L

- HS1L
- Actuators for HS1/HS5/HS6
- Actuators/Padlock Hasp

# HS5L Interlock Switches with Solenoid (2-Contact)

Two-contact solenoid interlock switches ideal for use on applications such as food machines and injection molding machines.



## Specifications

|  |   |
|--|---|
| Applicable Standards                           | EN ISO14119<br>GS-ET-19 (TÜV approval)<br>EN60947-5-1 (TÜV approval)<br>UL508 (UL listed)<br>CSA C22.2 No. 14 (c-UL listed)<br>GB/T14048.5 (CCC approval)<br>KS C IEC60947-5-1/S1-G-1/S2-E-4 (KOSHA approval) (*1)<br>IEC60204-1/EN60204-1 (applicable standards for use) |
| Type and Coded level                           | Type 2 low level coded interlocking device (ISO14119)   |
| Operating Temperature                          | -25 to +55°C (no freezing)  |
| Relative Humidity                              | 20 to 95% (no condensation)   |
| Storage Temperature                            | -40 to +80°C (no freezing)  |
| Pollution Degree                               | 3   |
| Impulse Withstand Voltage                      | 2.5kV<br>(between LED, solenoid and grounding: 0.5kV)   |
| Insulation Resistance<br>(500V DC megger)      | Between live and dead metal parts: 100MΩ min.<br>Between terminals of different poles: 100MΩ min.   |
| Electric Shock Protection                      | Class II (IEC61140)   |
| Degree of Protection                           | IP67 (IEC60529) Type 4X Indoor Use Only   |
| Shock Resistance                               | Operating extremes: 100m/s <sup>2</sup> (10G),<br>Damage limits: 1000m/s <sup>2</sup> (100G)  |
| Vibration Resistance                           | Operating extremes: 10 to 55Hz, amplitude 0.35 min.<br>Damage limits: 30Hz, amplitude 1.5mm min.  |
| Actuator Operating Speed                       | 0.05 to 1.0m/s  |
| Direct Opening Travel                          | 11.0mm min. (Actuator: HS9Z-A51/A5P)<br>12.0mm min. (Actuator: HS9Z-A52/A51A/A52A/A53/<br>A55/A55S/SH5/EH5L)<br>24.5mm min. (Actuator: HS9Z-BA5)  |
| Direct Opening Force                           | 120N min.   |
| Actuator Retention Force (*2)                  | Fzh = 1400N min. (GS-ET-19)<br>However, Fzh=500N min. when HS9Z-A55 is used   |
| Operating Frequency                            | 900 operations per hour   |
| Rear Unlocking Button<br>Mechanical Durability | 3,000 times min. (HS5L-□□□L)  |
| Mechanical Durability                          | 2,000,000 times min.<br>(Operation frequency 900 times/hour, actuator insert/remove,<br>solenoid operation) 100,000 times min. when using HS9Z-SH5/<br>EH5L/DH5 (actuator insert/remove)  |
| Electrical Durability                          | 100,000 times min. (Operating Frequency:<br>900 operations per hour)<br>2,000,000 times min. (24V AC/DC, 100mA)   |
| Conditional Short-circuit<br>Current           | 50A (250V) (Use 250V/10A fast-blow fuse for short-circuit<br>protection.)   |
| Cable  | 0.3mm <sup>2</sup> min. and 1.5mm <sup>2</sup> max. or AWG22 min. to AWG16 max.<br>strand wire or single wire   |
| Weight (Approx.)                               | 300g  |

\*1) Not applicable for all models. Visit IDEC's website for details.

\*2) See E-044 regarding actuator retention force.

## Ratings

### Contact Ratings

|                               |    |  |      |       |       |
|-------------------------------|----|--|------|-------|-------|
| Rated Insulation Voltage (Ui) |    | 250V<br>(between LED, solenoid and grounding: 30V) |      |       |       |
| Rated Current (Ith)           |    | 2.5A   |      |       |       |
| Rated Voltage (Ue)            |    | 30V  | 125V | 250V  |       |
| Rated Current<br>(Ie)*        | AC | Resistive Load (AC-12)                             | -    | 2.5A  | 1.5A  |
|                               |    | Inductive Load (AC-15)                             | -    | 1.5A  | 0.75A |
|                               | DC | Resistive Load (DC-12)                             | 2.5A | 1.1A  | 0.55A |
|                               |    | Inductive Load (DC-13)                             | 2.3A | 0.55A | 0.27A |

• Minimum applicable load (reference): 3V AC/DC, 5mA  
(Applicable range may vary with operating conditions and load types.)

\* UL, c-UL rating: Pilot Duty AC 0.75A/250V,  
Pilot Duty DC 1.0A/30V

TÜV rating: AC-15 0.75A/250V, DC-13 2.3A/30V

CCC rating: AC-15 0.75A/250V, DC-13 2.3A/30V

KOSHA rating: AC-15 0.75A/250V, DC-13 1.0A/30V (\*1)

### Solenoid

| Locking Mechanism                     | Spring Lock                        | Solenoid Lock |
|---------------------------------------|------------------------------------|---------------|
| Rated Voltage                         | 100% duty cycle 24V DC             |               |
| Rated Current                         | 200mA (initial value)              |               |
| Coil Resistance                       | 120Ω (at 20°C)                     |               |
| Pickup Voltage                        | Rated voltage × 85% max. (at 20°C) |               |
| Dropout Voltage                       | Rated voltage × 10% min. (at 20°C) |               |
| Maximum Continuous Applicable Voltage | Rated voltage × 110%               |               |
| Maximum Continuous Applicable Time    | Continuous                         |               |
| Insulation Class                      | Class F                            |               |

### Indicator

|                    |           |
|--------------------|-----------|
| Rated Voltage      | 24V DC    |
| Rated Current      | 10mA      |
| Light Source       | LED       |
| Illumination Color | G (Green) |

HS5L Interlock Switches with Solenoid (2-Contact)

2-Contact

Package Quantity: 1

| Circuit Code | Contact Configuration   | Gland Port Size | Spring lock                                 | Solenoid      |
|--------------|---|-----------------|---|---------------|
|              |   |                 | Part No.                                    |               |
| XD           | Door Monitor (Actuator inserted)<br>Lock Monitor (Spring lock → Solenoid OFF, Solenoid lock → Solenoid ON)<br><br>Door Monitor Circuit: 1NC<br>Monitor Circuit: 11, 12<br>Lock Monitor Circuit: 1NC<br>Monitor Circuit: 41, 42 (Note) | M20             | HS5L-XD44M-G                                | HS5L-XD7Y4M-G |
|              |   |                 | HS5L-XD44LM-G (Rear Unlocking Button Model) |               |
| XF           | Door Monitor Circuit: 2NC<br>Monitor Circuit: 11, 12<br>Monitor Circuit: 21, 22   |                 | —   | HS5L-XF7Y4M-G |
| XG           | Door Monitor Circuit: 1NC, 1NO<br>Monitor Circuit: 11, 12<br>Monitor Circuit: 23, 24  |                 | —   | HS5L-XG7Y4M-G |
| XH           | Lock Monitor Circuit: 2NC<br>Monitor Circuit: 41, 42 (Note)<br>Monitor Circuit: 51, 52 (Note)   |                 | HS5L-XH44M-G                                | HS5L-XH7Y4M-G |
| XH           | Monitor Circuit: 41, 42 (Note)<br>Monitor Circuit: 51, 52 (Note)  |                 | HS5L-XH44LM-G (Rear Unlocking Button Model) |               |
| XJ           | Lock Monitor Circuit: 1NC, 1NO<br>Monitor Circuit: 41, 42 (Note)<br>Monitor Circuit: 53, 54   | HS5L-XJ44M-G    | HS5L-XJ7Y4M-G                               |               |

- The contact configuration shows the status when the actuator is inserted and the switch is locked.
- Actuators are not supplied with the interlock switch and must be ordered separately.
- Contact us for details of two-conduit model. (Part No: HS5L-□□□□SM-G)

Note: Both spring lock and solenoid lock models of HS5L have marking for lock monitoring. Note that solenoid lock model can be used in applications where lock for safety purpose is found unnecessary after a risk assessment, e.g. locking is needed for purposes such as in production process.

Circuit Diagrams and Operating Characteristics

Spring Lock

| Interlock Switch Status                    | Status 1   | Status 2  | Status 3  | Status 4   | When unlocking manually   |
|--|--|---|---|--|---|
|  | Door Closed<br>Machine ready to operate<br>Solenoid de-energized   | Door Closed<br>Machine cannot be operated<br>Solenoid energized | Door open<br>Machine cannot be operated<br>Solenoid energized | Door open<br>Machine cannot be operated<br>Solenoid de-energized |   |
| Door Status                                |  |   |   |  | <br>Turn the manual unlock key (*1)<br><br>Press the rear unlocking button (*2) |
| Circuit Example: HS5L-XD4                  |  |   |   |  |   |
| Door                                       | Closed (locked)  | Closed (unlocked)   | Open  | Open   | Closed (unlocked)   |
| Part No. Circuit Diagram                   | HS5L-XD4<br>Door Monitor (Actuator inserted)<br>Lock Monitor (Solenoid OFF)<br>Monitor Circuit (door closed) 11-12<br>Monitor Circuit (locked) 41-42 |   |   |  |   |
|  | HS5L-XH4<br>Monitor Circuit (locked) 41-42<br>Monitor Circuit (locked) 51-52   |   |   |  |   |
| Solenoid Power A1-A2 (common to all types) | OFF (de-energized)   | ON (energized)  | ON (energized)  | OFF (de-energized)   | OFF (de-energized)  |

- The contact configuration shows the status when the actuator is inserted and the switch is locked.
- Monitor Circuit: Sends monitoring signals of protective door open/closed status door monitor) or protective door lock/unlock status (lock monitor).

\*1) Actuator can be unlocked manually for confirming the door movement before wiring and energizing, and also for emergency situation such as power failure.

\*2) When an operator is confined within a dangerous zone, the actuator can be unlocked manually by pressing the rear unlocking button (rear unlocking button model).

- APEM
- Switches & Pilot Lights
- Control Boxes
- Emergency Stop Switches
- Enabling Switches
- Safety Products
- Explosion Proof
- Terminal Blocks
- Relays & Sockets
- Circuit Protectors
- Power Supplies
- LED Illumination
- Controllers
- Operator Interfaces
- Sensors
- AUTO-ID

- Interlock Switches
- Non-contact Interlock Switches
- Safety Laser Scanners
- Safety Light Curtains
- Safety Modules
- HS6B
- HS6E
- HS5D
- HS5L

- HS1L
- Actuators for HS1/HS5/HS6
- Actuators/ Padlock Hasp

# HS5L Interlock Switches with Solenoid (2-Contact)

## Circuit Diagrams and Operating Characteristics

### Solenoid Lock

| Interlock Switch Status  | Status 1   | Status 2   | Status 3   | Status 4  | Unlocking using Manual Unlock Key                |  |
|--|--|--|--|---|--|--|
|  | Door Closed<br>Machine ready to operate<br>Solenoid energized  | Door Closed<br>Machine cannot be operated<br>Solenoid de-energized | Door open<br>Machine cannot be operated<br>Solenoid de-energized | Door open<br>Machine cannot be operated<br>Solenoid energized |  | Door Closed<br>Machine cannot be operated<br>Solenoid de-energized → energized |
| Door Status  |  |  |  |   |  |  |
| Circuit Example: HS5L-XD7Y   |  |  |  |   |  |  |
| Door   | Closed (locked)  | Closed (unlocked)  | Open   | Open  | Closed (unlocked)                                |  |
| Part No. and Circuit Diagram   | <b>HS5L-XD7Y</b><br>Door Monitor (Actuator inserted)<br>Lock Monitor (Solenoid ON)<br>Monitor Circuit: 11-12<br>Monitor Circuit: 41-42 | Monitor Circuit (door closed) 11-12                                |  |   |  |  |
|  |  | Monitor Circuit (locked) 41-42                                     |  |   |  |  |
|  | <b>HS5L-XF7Y (*3)</b><br>Monitor Circuit: 11-12<br>Monitor Circuit: 21-22  | Monitor Circuit (door closed) 11-12                                |  |   |  |  |
|  |  | Monitor Circuit (door closed) 21-22                                |  |   |  |  |
|  | <b>HS5L-XG7Y (*3)</b><br>Monitor Circuit: 11-12<br>Monitor Circuit: 23-24  | Monitor Circuit (door closed) 11-12                                |  |   |  |  |
|  |  | Monitor Circuit (door open) 23-24                                  |  |   |  |  |
| <b>HS5L-XH7Y</b><br>Monitor Circuit: 41-42<br>Monitor Circuit: 51-52 | Monitor Circuit (locked) 41-42   |  |  |   |  |  |
|  | Monitor Circuit (locked) 51-52   |  |  |   |  |  |
| <b>HS5L-XJ7Y</b><br>Monitor Circuit: 41-42<br>Monitor Circuit: 53-54 |  |  |  |   |  |  |
| Solenoid Power A1-A2 (all models)                                    | OFF (energized)  | OFF (de-energized)   | OFF (de-energized)   | ON (energized) (*2)   | (*1) (*2)<br>OFF (de-energized) → ON (energized) |  |

- The contact configuration shows the status when the actuator is inserted and the switch is locked.
  - Monitor Circuit: Sends monitoring signals of protective door open/closed status (door monitor) or protective door lock/unlock status (lock monitor).
- \*1) Do not unlock manually while the solenoid is energized.  
 \*2) Do not energize the solenoid for a long period of time while the door is open or while the door is unlocked manually.  
 \*3) Circuit codes XF and XG do not have signals to notify whether the switch is locked or unlocked. A different method should be used to check the lock status.  
 \*4) Both spring lock and solenoid lock models of HS5L have marking for lock monitoring. Note that solenoid lock model can be used in applications where lock for safety purpose is found unnecessary after a risk assessment, e.g. locking is needed for purposes such as in production process.

### Operation Characteristics (Reference)

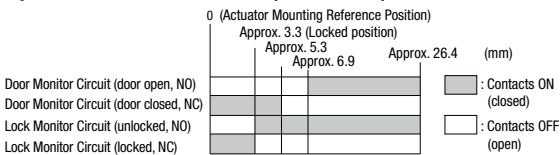

- The operation characteristics shown in the chart above are for HS9Z-A51. For other actuators, add 1.3mm.
- See E-051 for HS9Z-BA5.
- The operation characteristics show the contact status when the actuator enters the entry slot of an interlock switch.

APEM

Switches &amp; Pilot Lights

Control Boxes

Emergency Stop Switches

Enabling Switches

Safety Products

Explosion Proof

Terminal Blocks

Relays &amp; Sockets

Circuit Protectors

Power Supplies

LED Illumination

Controllers

Operator Interfaces

Sensors

AUTO-ID

Interlock Switches

Non-contact Interlock Switches

Safety Laser Scanners

Safety Light Curtains

Safety Modules

HS6B

HS6E

HS5D

HS5L

HS1L

Actuators for HS1/HS5/HS6

Actuators/ Padlock Hasp

# HS5L Interlock Switch with Solenoid (4-Contact)

Four-contact solenoid interlock switches ideal for use on limited mounting spaces such as small doors.



## Specifications

|   |   |
|---|---|
| Applicable Standards                        | EN ISO14119<br>GS-ET-19 (TÜV approval)<br>EN60947-5-1 (TÜV approval)<br>UL508 (UL listed)<br>CSA C22.2 No. 14 (c-UL listed)<br>GB/T14048.5 (CCC approval)<br>KS C IEC60947-5-1/S1-G-1/S2-E-4 (KOSHA approval) (*1)<br>IEC60204-1/EN60204-1 (Applicable standards for use) |
| Type and Coded Level                        | Type 2 low level coded interlocking device (EN/ISO14119)  |
| Operating Temperature                       | -25 to + 55°C (no freezing)   |
| Relative Humidity                           | 20 to 95% (no condensation)   |
| Storage Temperature                         | -40 to +80°C (no freezing)  |
| Pollution Degree                            | 3   |
| Impulse Withstand Voltage                   | 2.5kV (between LED, solenoid and grounding: 0.5kV)  |
| Insulation Resistance (500V DC megger)      | Between live and dead metal parts: 100MΩ min.<br>Between terminals of different poles: 100MΩ min.   |
| Electric Shock Protection                   | Class II (IEC61140)   |
| Degree of Protection                        | IP67 (IEC60529) Type 4X Indoor Use Only   |
| Shock Resistance                            | Operating extremes: 100m/s <sup>2</sup> (10G)<br>Damage limits: 1000m/s <sup>2</sup> (100G)   |
| Vibration Resistance                        | Operating extremes: 10 to 55Hz, amplitude 0.35 min.<br>Damage limits: 30Hz, amplitude 1.5mm min.  |
| Actuator Operating Speed                    | 0.05 to 1.0m/s  |
| Direct Opening Travel                       | 11.0mm min. (Actuator: HS9Z-A51/A5P)<br>12.0mm min. (Actuator: HS9Z-A52/A51A/A52A/A53/A55/A55S/SH5/EH5L)<br>24.5mm min. (Actuator: HS9Z-BA5)  |
| Direct Opening Force                        | 120N min.   |
| Actuator Retention Force (*2)               | Fzh = 1400N min. (GS-ET-19)<br>However, Fzh=500N min. when HS9Z-A55 is used   |
| Operating Frequency                         | 900 operations per hour   |
| Rear Unlocking Button Mechanical Durability | 3,000 times min. (HS5L-□□L)   |
| Mechanical Durability                       | 2,000,000 times min.<br>(Operation frequency 900 times/hour, actuator insert/remove, solenoid operation) 100,000 times min. when HS9Z-SH5/EH5L/DH5 (actuator insert/remove)   |
| Electrical Durability                       | 100,000 times min. (Operating Frequency: 900 operations per hour)<br>2,000,000 times min. (24V AC/DC, 100mA)  |
| Conditional Short-circuit Current           | 50A (250V) (Use 250V/10A fast-blow fuse for short-circuit protection.)  |
| Cable                                       | 0.3mm <sup>2</sup> min. and 1.5mm <sup>2</sup> max. or AWG22 min. to AWG16 max. strand wire or single wire  |
| Weight (Approx.)                            | 300g  |

\*1) Not applicable for all models. Visit IDEC's website for details.

\*2) See E-044 regarding actuator retention force.

## Ratings

### Contact Ratings

|                               |   |                        |      |       |       |
|-------------------------------|---|------------------------|------|-------|-------|
| Rated Insulation Voltage (Ui) | 250V (between LED, solenoid and grounding: 30V) |                        |      |       |       |
| Rated Current (Ith)           | 2.5A  |                        |      |       |       |
| Rated Voltage (Ue)            | 30V   | 125V                   | 250V |       |       |
| Rated Current (Ie)*           | AC  | Resistive Load (AC-12) | -    | 2.5A  | 1.5A  |
|                               |   | Inductive Load (AC-15) | -    | 1.5A  | 0.75A |
|                               | DC  | Resistive Load (DC-12) | 2.5A | 1.1A  | 0.55A |
|                               |   | Inductive Load (DC-13) | 2.3A | 0.55A | 0.27A |

• Minimum applicable load (reference): 3V AC/DC, 5mA  
(Applicable range may vary with operating conditions and load types.)

\* UL, c-UL rating: Pilot Duty AC 0.75A/250V,  
Pilot Duty DC 1.0A/30V

TÜV rating: AC-15 0.75A/250V, DC-13 2.3A/30V

CCC rating: AC-15 0.75A/250V, DC-13 2.3A/30V

KOSHA rating: AC-15 0.75A/250V, DC-13 1.0A/30V (\*1)

### Solenoid

|                                       |                                    |               |
|---------------------------------------|------------------------------------|---------------|
| Locking Mechanism                     | Spring Lock                        | Solenoid Lock |
| Rated Voltage                         | 100% duty cycle 24V DC             |               |
| Rated Current                         | 200mA (initial value)              |               |
| Coil Resistance                       | 120Ω (at 20°C)                     |               |
| Pickup Voltage                        | Rated voltage × 85% max. (at 20°C) |               |
| Dropout Voltage                       | Rated voltage × 10% min. (at 20°C) |               |
| Maximum Continuous Applicable Voltage | Rated voltage × 110%               |               |
| Maximum Continuous Applicable Time    | Continuous                         |               |
| Insulation Class                      | Class F                            |               |

### Indicator

|                    |           |
|--------------------|-----------|
| Rated Voltage      | 24V DC    |
| Rated Current      | 10mA      |
| Light Source       | LED       |
| Illumination Color | G (Green) |

# HS5L Interlock Switch with Solenoid (4-Contact)

## HS5L Interlock Switches with Solenoid (4-Contact)

### 4-Contact (Spring Lock/Solenoid Lock)

Package Quantity: 1

| Circuit Code | Contact Configuration  | Gland Port Size | Spring lock                       | Solenoid                           |
|--------------|--|-----------------|-----------------------------------|------------------------------------|
|              |  |                 | Part No.                          |                                    |
| VA           | <p>Door Monitor (Actuator inserted)</p> <p>Door Monitor: 1NC, 1NO<br/>                     Monitor Circuit: 11-12, 23-24<br/>                     Lock Monitor Circuit: 1NC, 1NO<br/>                     Monitor Circuit: 41-42, 53-54 (Note)</p> | M20             | HS5L-VA44M-G                      | HS5L-VA7Y4M-G                      |
|              |  |                 | HS5L-VA44SM-G (two-conduit model) | HS5L-VA7Y4SM-G (two-conduit model) |
| VB           | <p>Door Monitor: 1NC, 1NO</p> <p>Monitor Circuit: 11-12, 23-24</p> <p>Lock Monitor Circuit: 2NC</p> <p>Monitor Circuit: 41-42, 51-52 (Note)</p>  | M20             | HS5L-VB44M-G                      | HS5L-VB7Y4M-G                      |
|              |  |                 |                                   | HS5L-VB7Y4SM-G (two-conduit model) |
| VC           | <p>Door Monitor: 2NC</p> <p>Monitor Circuit: 11-12, 21-22</p> <p>Lock Monitor Circuit: 1NC, 1NO</p> <p>Monitor Circuit: 41-42, 53-54 (Note)</p>  | M20             | HS5L-VC44M-G                      | HS5L-VC7Y4M-G                      |
|              |  |                 | HS5L-VC44SM-G (two-conduit model) | HS5L-VC7Y4SM-G (two-conduit model) |
| VD           | <p>Door Monitor: 2NC</p> <p>Monitor Circuit: 11-12, 21-22</p> <p>Lock Monitor Circuit: 2NC</p> <p>Monitor Circuit: 41-42, 51-52 (Note)</p>   | M20             | HS5L-VD44M-G                      | HS5L-VD7Y4M-G                      |
|              |  |                 | HS5L-VD44SM-G (two-conduit model) | HS5L-VD7Y4SM-G (two-conduit model) |
| VF           | <p>Door Monitor: 3NC</p> <p>Monitor Circuit: 11-12, 21-22, 31-32</p> <p>Lock Monitor Circuit: 1NC</p> <p>Monitor Circuit: 41-42 (Note)</p>   | M20             | HS5L-VF44M-G                      | HS5L-VF7Y4M-G                      |
|              |  |                 | HS5L-VF44SM-G (two-conduit model) | HS5L-VF7Y4SM-G (two-conduit model) |
| VG           | <p>Door Monitor: 2NC, 1NO</p> <p>Monitor Circuit: 11-12, 21-22, 33-34</p> <p>Lock Monitor Circuit: 1NC</p> <p>Monitor Circuit: 41-42 (Note)</p>  | M20             | HS5L-VG44M-G                      | HS5L-VG7Y4M-G                      |
|              |  |                 | HS5L-VG44SM-G (two-conduit model) | HS5L-VG7Y4SM-G (two-conduit model) |
| VH           | <p>Door Monitor: 1NC</p> <p>Monitor Circuit: 11-12</p> <p>Lock Monitor Circuit: 3NC</p> <p>Monitor Circuit: 41-42, 51-52, 61-62 (Note)</p>   | M20             | HS5L-VH44M-G                      | HS5L-VH7Y4M-G                      |
|              |  |                 |                                   |                                    |
| VJ           | <p>Door Monitor: 1NC</p> <p>Monitor Circuit: 11-12</p> <p>Lock Monitor Circuit: 2NC, 1NO</p> <p>Monitor Circuit: 41-42, 51-52, 63-64 (Note)</p>  | M20             | HS5L-VJ44M-G                      | HS5L-VJ7Y4M-G                      |
|              |  |                 |                                   |                                    |
| VW           | <p>Door Monitor: 1NO</p> <p>Monitor Circuit: 13-14</p> <p>Lock Monitor Circuit: 3NC</p> <p>Monitor Circuit: 41-42, 51-52, 61-62 (Note)</p>   | M20             | HS5L-VW44M-G                      | HS5L-VW7Y4M-G                      |
|              |  |                 |                                   |                                    |
| VX           | <p>Door Monitor: 1NO</p> <p>Monitor Circuit: 13-14</p> <p>Lock Monitor Circuit: 2NC, 1NO</p> <p>Monitor Circuit: 41-42, 51-52, 63-64 (Note)</p>  | M20             | HS5L-VX44M-G                      | HS5L-VX7Y4M-G                      |
|              |  |                 |                                   |                                    |

- The contact configuration shows the status when the actuator is inserted and the switch is locked.
- Actuators are not supplied with the interlock switch and must be ordered separately.
- For safety circuit input, connect to the monitor circuit with marking.
- Contact us for details of two-conduit model. (Part No: HS5L-□□□□SM-G)

Note: Both spring lock and solenoid lock models of HS5L have marking for lock monitoring. Note that solenoid lock model can be used in applications where lock for safety purpose is found unnecessary after a risk assessment, e.g. locking is needed for purposes such as in production process.

4-Contact/Rear Unlocking Button (Spring Lock)

Package Quantity: 1

| Circuit Code | Contact Configuration  | Gland Port Size | Spring lock                           |
|--------------|--|-----------------|---------------------------------------|
|              |  |                 | Part No.                              |
| VA           | <p>Door Monitor Circuit: 1NC,1NO<br/>Lock Monitor Circuit: 1NC,1NO</p> <p>Monitor Circuit: ⊖ 11 12<br/>Monitor Circuit: 23 24<br/>Monitor Circuit:</p>   | M20             | HS5L-VA44LM-G                         |
|              |  |                 | HS5L-VB44LM-G                         |
| VB           | <p>Door Monitor Circuit: 1NC,1NO<br/>Lock Monitor Circuit: 2NC</p> <p>Monitor Circuit: ⊖ 11 12<br/>Monitor Circuit: 23 24<br/>Monitor Circuit:</p>       | M20             | HS5L-VB44LSM-G<br>(two-conduit model) |
|              |  |                 | HS5L-VC44LM-G                         |
| VC           | <p>Door Monitor Circuit: 2NC<br/>Lock Monitor Circuit: 1NC,1NO</p> <p>Monitor Circuit: ⊖ 11 12<br/>Monitor Circuit: ⊖ 21 22<br/>Monitor Circuit:</p>     | M20             | HS5L-VD44LM-G                         |
|              |  |                 | HS5L-VD44LSM-G<br>(two-conduit model) |
| VD           | <p>Door Monitor Circuit: 2NC<br/>Lock Monitor Circuit: 2NC</p> <p>Monitor Circuit: ⊖ 11 12<br/>Monitor Circuit: ⊖ 21 22<br/>Monitor Circuit:</p>         | M20             | HS5L-VF44LM-G                         |
|              |  |                 | HS5L-VJ44LM-G                         |
| VF           | <p>Door Monitor Circuit: 3NC<br/>Lock Monitor Circuit: 1NC</p> <p>Monitor Circuit: ⊖ 11 12<br/>Monitor Circuit: ⊖ 21 22<br/>Monitor Circuit: ⊖ 31 22</p> | M20             | HS5L-VJ44LSM-G<br>(two-conduit model) |
|              |  |                 |                                       |

- The contact configuration shows the status when the actuator is inserted and the switch is locked.
- Actuators are not supplied with the interlock switch and must be ordered separately.

4-Contact/Dual Safety Circuit (Spring Lock)

Package Quantity: 1

| Circuit Code | Contact Configuration   | Gland Port Size | Spring lock                          |
|--------------|---|-----------------|--------------------------------------|
|              |   |                 | Part No.                             |
| DD           | <p>Main Circuit: 1NC+1NC<br/>1NC+1NC</p> <p>Door Monitor (Actuator inserted)<br/>Lock Monitor (Solenoid OFF)</p> <p>Main Circuit: ⊖ 11 12<br/>Main Circuit: ⊖ 21 22</p> | M20             | HS5L-DD44M-G                         |
|              |   |                 | HS5L-DD44SM-G<br>(two-conduit model) |

- The contact configuration shows the status when the actuator is inserted and the switch is locked.
- Actuators are not supplied with the interlock switch and must be ordered separately.

4-Contact/Dual Safety Circuit/Rear Unlocking Button (Spring Lock)

Package Quantity: 1

| Circuit Code | Contact Configuration   | Gland Port Size | Spring lock                           |
|--------------|---|-----------------|---------------------------------------|
|              |   |                 | Part No.                              |
| DD           | <p>Main Circuit: 1NC+1NC<br/>1NC+1NC</p> <p>Door Monitor (Actuator inserted)<br/>Lock Monitor (Solenoid OFF)</p> <p>Main Circuit: ⊖ 11 12<br/>Main Circuit: ⊖ 21 22</p> | M20             | HS5L-DD44LM-G                         |
|              |   |                 | HS5L-DD44LSM-G<br>(two-conduit model) |

- The contact configuration shows the status when the actuator is inserted and the switch is locked.
- Actuators are not supplied with the interlock switch and must be ordered separately.

- APEM
- Switches & Pilot Lights
- Control Boxes
- Emergency Stop Switches
- Enabling Switches
- Safety Products
- Explosion Proof
- Terminal Blocks
- Relays & Sockets
- Circuit Protectors
- Power Supplies
- LED Illumination
- Controllers
- Operator Interfaces
- Sensors
- AUTO-ID

- Interlock Switches
- Non-contact Interlock Switches
- Safety Laser Scanners
- Safety Light Curtains
- Safety Modules

- HS6B
- HS6E
- HS5D
- HS5L

- HS1L
- Actuators for HS1/HS5/HS6
- Actuators/ Padlock Hasp



# HS5L Interlock Switch with Solenoid (4-Contact)

## Circuit Diagrams and Operating Characteristics

### 4-Contact/Rear Unlocking Button (Spring Lock)

|                                     | Status 1   | Status 2  | Status 3  | Status 4   | When unlocking manually  |                    |
|-------------------------------------|--|---|---|--|--|--------------------|
| <b>Interlock Switch Status</b>      | Door Closed<br>Machine ready to operate<br>Solenoid de-energized   | Door Closed<br>Machine cannot be operated<br>Solenoid energized | Door open<br>Machine cannot be operated<br>Solenoid energized | Door open<br>Machine cannot be operated<br>Solenoid de-energized | Door Closed<br>Machine cannot be operated<br>Solenoid de-energized |                    |
| <b>Door Status</b>                  |  |   |   |  |  |                    |
| <b>Circuit Example: HS5L-VA4</b>    |  |   |   |  |  |                    |
| <b>Door</b>                         | Closed (locked)  | Closed (unlocked)   | Open  | Open   | Closed (unlocked)  |                    |
| <b>Part No. and Circuit Diagram</b> | <b>HS5L-VA4</b><br>Door Monitor (Actuator inserted) Lock Monitor (Solenoid OFF)<br><br>Monitor Circuit: 11-12, 23-24, 41-42, 53-54 |   |   |  |  |                    |
|                                     | <b>HS5L-VB4</b><br>Monitor Circuit: 11-12, 23-24, 41-42, 51-52   |   |   |  |  |                    |
|                                     | <b>HS5L-VC4</b><br>Monitor Circuit: 11-12, 21-22, 41-42, 53-54   |   |   |  |  |                    |
|                                     | <b>HS5L-VD4</b><br>Monitor Circuit: 11-12, 21-22, 41-42, 51-52   |   |   |  |  |                    |
|                                     | <b>HS5L-VF4</b><br>Monitor Circuit: 11-12, 21-22, 31-32, 41-42   |   |   |  |  |                    |
|                                     | <b>HS5L-VG4</b><br>Monitor Circuit: 11-12, 21-22, 33-34, 41-42   |   |   |  |  |                    |
|                                     | <b>HS5L-VH4</b><br>Monitor Circuit: 11-12, 41-42, 51-52, 61-62   |   |   |  |  |                    |
|                                     | <b>Solenoid Power A1-A2 (all models)</b>   | OFF (de-energized)  | ON (energized)  | ON (energized)   | OFF (de-energized)   | OFF (de-energized) |

- The contact configuration shows the status when the actuator is inserted and the switch is locked.
- Monitor Circuit: Sends monitoring signals of protective door open/closed status (door monitor) or protective door lock/unlock status (lock monitor).
- \*1) Actuator can be unlocked manually for confirming the door movement before wiring and energizing, and also for emergency situation such as power failure.
- \*2) When an operator is confined within a dangerous zone, the actuator can be unlocked manually by pressing the rear unlocking button (rear unlocking button model).

**Circuit Diagrams and Operating Characteristics**  
**4-Contact/Rear Unlocking Button (Spring Lock)**

|                              |  | Status 1   | Status 2  | Status 3  | Status 4   | When unlocking manually   |
|------------------------------|--|--|---|---|--|---|
| Interlock Switch Status      |  | Door Closed<br>Machine ready to operate<br>Solenoid de-energized   | Door Closed<br>Machine cannot be operated<br>Solenoid energized | Door open<br>Machine cannot be operated<br>Solenoid energized | Door open<br>Machine cannot be operated<br>Solenoid de-energized | Door Closed<br>Machine cannot be operated<br>Solenoid de-energized              |
| Door Status                  |  |  |   |   |  | <br>Turn the manual unlock key (*1)<br><br>Press the rear unlocking button (*2) |
| Circuit Example: HS5L-VA4    |  |  |   |   |  |   |
| Door                         |  | Closed (locked)  | Closed (unlocked)   | Open  | Open   | Closed (unlocked)   |
| Part No. and Circuit Diagram | HS5L-VJ4<br>Door Monitor (Actuator inserted)<br>Lock Monitor (Solenoid ON) | Monitor Circuit (door closed) 11-12<br>Monitor Circuit (locked) 41-42<br>Monitor Circuit (locked) 51-52<br>Monitor Circuit (door locked) 63-64 |   |   |  |   |
|                              | HS5L-VW4   | Monitor Circuit (door open) 13-14<br>Monitor Circuit (locked) 41-42<br>Monitor Circuit (locked) 51-52<br>Monitor Circuit (locked) 61-62        |   |   |  |   |
|                              | HS5L-VX4   | Monitor Circuit (door open) 13-14<br>Monitor Circuit (locked) 41-42<br>Monitor Circuit (locked) 51-52<br>Monitor Circuit (unlocked) 63-64      |   |   |  |   |
|                              | Solenoid Power A1-A2 (all models)  | OFF (de-energized)   | ON (energized)  | ON (energized)  | OFF (de-energized)   | OFF (de-energized)  |

- The contact configuration shows the status when the actuator is inserted and the switch is locked.
  - Monitor Circuit: Sends monitoring signals of protective door open/closed status (door monitor) or protective door lock/unlock status (lock monitor).
- \*1) Actuator can be unlocked manually for confirming the door movement before wiring and energizing, and also for emergency situation such as power failure.  
 \*2) When an operator is confined within a dangerous zone, the actuator can be unlocked manually by pressing the rear unlocking button (rear unlocking button model).

- APEM
- Switches & Pilot Lights
- Control Boxes
- Emergency Stop Switches
- Enabling Switches
- Safety Products
- Explosion Proof
- Terminal Blocks
- Relays & Sockets
- Circuit Protectors
- Power Supplies
- LED Illumination
- Controllers
- Operator Interfaces
- Sensors
- AUTO-ID
- Interlock Switches
- Non-contact Interlock Switches
- Safety Laser Scanners
- Safety Light Curtains
- Safety Modules

HS6B

HS6E

HS5D

HS5L

HS1L

Actuators for HS1/HS5/HS6  
 Actuators/Padlock Hasp

# HS5L Interlock Switch with Solenoid (4-Contact)

## Circuit Diagrams and Operating Characteristics

### 4-Contact (Solenoid Lock)

| Interlock Switch Status      | Status 1   | Status 2   | Status 3   | Status 4  | Unlocking using Manual Unlock Key |   |
|------------------------------|--|--|--|---|-----------------------------------|---|
|                              | Door Closed<br>Machine ready to operate<br>Solenoid energized  | Door Closed<br>Machine cannot be operated<br>Solenoid de-energized | Door open<br>Machine cannot be operated<br>Solenoid de-energized | Door open<br>Machine cannot be operated<br>Solenoid energized |                                   | Door Closed<br>Machine cannot be operated<br>Solenoid de-energized<br>→ energized |
| Door Status                  |  |  |  |   |                                   |   |
| Circuit Example: HS5L-VA7Y   |  |  |  |   |                                   |   |
| Door                         | Closed (locked)  | Closed (unlocked)  | Open   | Open  | Closed (unlocked)                 |   |
| Part No. and Circuit Diagram | <b>HS5L-VA7Y</b><br><br>Monitor Circuit (door closed) 11-12<br>Monitor Circuit (door open) 23-24<br>Monitor Circuit (locked) 41-42<br>Monitor Circuit (unlocked) 53-54   |  |  |   |                                   |   |
|                              | <b>HS5L-VB7Y</b><br><br>Monitor Circuit (door closed) 11-12<br>Monitor Circuit (door open) 23-24<br>Monitor Circuit (locked) 41-42<br>Monitor Circuit (unlocked) 51-52   |  |  |   |                                   |   |
|                              | <b>HS5L-VC7Y</b><br><br>Monitor Circuit (door closed) 11-12<br>Monitor Circuit (door closed) 21-22<br>Monitor Circuit (locked) 41-42<br>Monitor Circuit (unlocked) 53-54 |  |  |   |                                   |   |
|                              | <b>HS5L-VD7Y</b><br><br>Monitor Circuit (door closed) 11-12<br>Monitor Circuit (door closed) 21-22<br>Monitor Circuit (locked) 41-42<br>Monitor Circuit (locked) 51-52   |  |  |   |                                   |   |
|                              | <b>HS5L-VF7Y</b><br><br>Monitor Circuit (door closed) 11-12<br>Monitor Circuit (door closed) 21-22<br>Monitor Circuit (locked) 31-32<br>Monitor Circuit (locked) 41-42   |  |  |   |                                   |   |
|                              | Solenoid Power A1-A2 (all models)  | ON (energized)   | OFF (de-energized)   | OFF (de-energized)  | ON (energized) (*2)               | OFF (de-energized) <sup>(*)</sup> → ON (energized)                                |

- The contact configuration shows the status when the actuator is inserted and the switch is locked.
- Monitor Circuit: Sends monitoring signals of protective door open/closed status (door monitor) or protective door lock/unlock status (lock monitor).

\*1) Do not attempt manual unlocking when the solenoid is energized.

\*2) Do not energize the solenoid for a long time while the door is open or when the door is unlocked manually.

\*3) Both spring lock and solenoid lock models of HS5L have marking for lock monitoring. Note that solenoid lock model can be used in applications where lock for safety purpose is found unnecessary after a risk assessment, e.g. locking is needed for purposes such as in production process.

### Operating Characteristics (Reference)

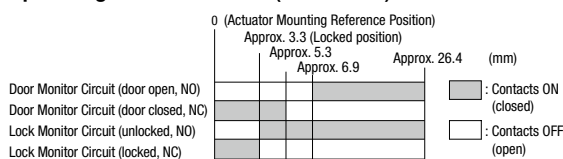

- The operation characteristics shown in the chart above are for HS9Z-A51. For other actuators, add 1.3mm.
- See **E-051** for HS9Z-BA5.
- The operation characteristics show the contact status when the actuator enters the entry slot of an interlock switch.

Circuit Diagrams and Operating Characteristics  
4-Contact (Solenoid Lock)

| Interlock Switch Status           | Status 1  | Status 2   | Status 3   | Status 4  | Unlocking using Manual Unlock Key                                 |  |
|-----------------------------------|---|--|--|---|---|--|
|                                   | Door Closed<br>Machine ready to operate<br>Solenoid energized   | Door Closed<br>Machine cannot be operated<br>Solenoid de-energized | Door open<br>Machine cannot be operated<br>Solenoid de-energized | Door open<br>Machine cannot be operated<br>Solenoid energized |   | Door Closed<br>Machine cannot be operated<br>Solenoid de-energized → energized |
| Door Status                       |   |  |  |   |   |  |
| Circuit Example: HS5L-VA7Y        |   |  |  |   |   |  |
| Door                              | Closed (locked)   | Closed (unlocked)  | Open   | Open  | Closed (unlocked)   |  |
| Part No. and Circuit Diagram      | <b>HS5L-VG7Y</b><br>Door Monitor (Actuator inserted) Lock Monitor (Solenoid ON)<br><br>Monitor Circuit: 11-12, 41-42 (NC)<br>Monitor Circuit: 21-22<br>Monitor Circuit: 33-34 | Monitor Circuit (door closed) 11-12                                |  |   |   |  |
|                                   |   | Monitor Circuit (door closed) 21-22                                |  |   |   |  |
|                                   |   | Monitor Circuit (door open) 33-34                                  |  |   |   |  |
|                                   |   | Monitor Circuit (locked) 41-42                                     |  |   |   |  |
|                                   | <b>HS5L-VH7Y</b><br>Monitor Circuit: 11-12, 41-42 (NC)<br>Monitor Circuit: 51-52 (NC)<br>Monitor Circuit: 61-62 (NC)  | Monitor Circuit (door closed) 11-12                                |  |   |   |  |
|                                   |   | Monitor Circuit (locked) 41-42                                     |  |   |   |  |
|                                   |   | Monitor Circuit (locked) 51-52                                     |  |   |   |  |
|                                   |   | Monitor Circuit (unlock) 63-64                                     |  |   |   |  |
|                                   | <b>HS5L-VJ7Y</b><br>Monitor Circuit: 11-12, 41-42 (NC)<br>Monitor Circuit: 51-52 (NC)<br>Monitor Circuit: 63-64   | Monitor Circuit (door open) 13-14                                  |  |   |   |  |
|                                   |   | Monitor Circuit (locked) 41-42                                     |  |   |   |  |
|                                   |   | Monitor Circuit (locked) 51-52                                     |  |   |   |  |
|                                   |   | Monitor Circuit (unlocked) 63-64                                   |  |   |   |  |
|                                   | <b>HS5L-VW7Y</b><br>Monitor Circuit: 13-14, 41-42 (NC)<br>Monitor Circuit: 51-52 (NC)<br>Monitor Circuit: 61-62 (NC)  | Monitor Circuit (door open) 13-14                                  |  |   |   |  |
|                                   |   | Monitor Circuit (locked) 41-42                                     |  |   |   |  |
|                                   |   | Monitor Circuit (locked) 51-52                                     |  |   |   |  |
|                                   |   | Monitor Circuit (locked) 61-62                                     |  |   |   |  |
|                                   | <b>HS5L-VX7Y</b><br>Monitor Circuit: 13-14, 41-42 (NC)<br>Monitor Circuit: 51-52 (NC)<br>Monitor Circuit: 63-64   | Monitor Circuit (door open) 13-14                                  |  |   |   |  |
|                                   |   | Monitor Circuit (locked) 41-42                                     |  |   |   |  |
|                                   |   | Monitor Circuit (locked) 51-52                                     |  |   |   |  |
|                                   |   | Monitor Circuit (unlocked) 63-64                                   |  |   |   |  |
| Solenoid Power A1-A2 (all models) | ON (energized)  | OFF (de-energized)   | OFF (de-energized)   | ON (energized) (*2)   | OFF (de-energized) → ON (energized) <sup>(*)</sup> <sup>(*)</sup> |  |

- The contact configuration shows the status when the actuator is inserted and the switch is locked.
- Monitor Circuit: Sends monitoring signals of protective door open/closed status (door monitor) or protective door lock/unlock status (lock monitor).

\*1) Do not attempt manual unlocking when the solenoid is energized.

\*2) Do not energize the solenoid for a long time while the door is open or when the door is unlocked manually.

\*3) Both spring lock and solenoid lock models of HS5L have marking for lock monitoring. Note that solenoid lock model can be used in applications where lock for safety purpose is found unnecessary after a risk assessment, e.g. locking is needed for purposes such as in production process.

Operating Characteristics (Reference)

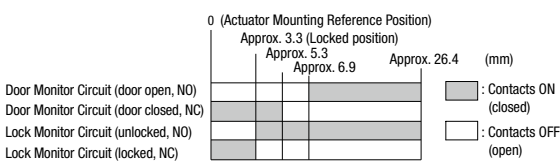

- The operation characteristics shown in the chart above are for HS9Z-A51. For other actuators, add 1.3mm.
- See E-051 for HS9Z-BA5.
- The operation characteristics show the contact status when the actuator enters the entry slot of an interlock switch.

- APEM
- Switches & Pilot Lights
- Control Boxes
- Emergency Stop Switches
- Enabling Switches
- Safety Products
- Explosion Proof
- Terminal Blocks
- Relays & Sockets
- Circuit Protectors
- Power Supplies
- LED Illumination
- Controllers
- Operator Interfaces
- Sensors
- AUTO-ID
- Interlock Switches
- Non-contact Interlock Switches
- Safety Laser Scanners
- Safety Light Curtains
- Safety Modules

HS6B

HS6E

HS5D

HS5L

HS1L

Actuators for HS1/HS5/HS6

Actuators/ Padlock Hasp

# HS5L Interlock Switch with Solenoid (4-Contact)

## Circuit Diagrams and Operating Characteristics

### 4-Contact/Dual Safety Circuit, 4-Contact/Dual Safety Circuit/Rear Unlocking Button (Spring Lock)

|                                  |   | Status 1   | Status 2  | Status 3  | Status 4   | Unlocking using Manual Unlock Key                                       |
|----------------------------------|---|--|---|---|--|---|
| Interlock Switch Status          |   | Door Closed<br>Machine ready to operate<br>Solenoid de-energized | Door Closed<br>Machine cannot be operated<br>Solenoid energized | Door open<br>Machine cannot be operated<br>Solenoid energized | Door open<br>Machine cannot be operated<br>Solenoid de-energized | Door Closed<br>Machine cannot be operated<br>Solenoid de-energized      |
| Door Status                      |   |  |   |   |  | Turn the manual unlock key (*1)<br>Press the rear unlocking button (*2) |
| Circuit Example: HS5L-DD4        |   |  |   |   |  |   |
| Door                             |   | Closed (locked)  | Closed (unlocked)   | Open  | Open   | Closed (unlocked)   |
| Part No. and Circuit Diagram     | HS5L-DD44<br>Door Monitor (Actuator inserted) Lock Monitor (Solenoid OFF)<br><br>Main Circuit: 11-12 41-42<br>Main Circuit: 21-22 51-52 | Main Circuit 11-42   |   |   |  |   |
|                                  |   | Main Circuit 21-52   |   |   |  |   |
|                                  | HS5L-DD44L<br>Main Circuit: 11-12 41-42<br>Main Circuit: 21-22 51-52  | Main Circuit 11-42   |   |   |  |   |
|                                  |   | Main Circuit 21-52   |   |   |  |   |
| Solenoid Power A1-A2 (all model) |   | OFF (de-energized)   | ON (energized)  | ON (energized)  | OFF (de-energized)   | OFF (de-energized) <sup>1</sup>   |

- The contact configuration shows the status when the actuator is inserted and the switch is locked.
- Main Circuit: Connected to the control circuit of machine drive part, sending interlock signals of the protective door.
- For safety circuit input, connect to the monitor circuit.

\*1) Actuator can be unlocked manually for confirming the door movement before wiring and energizing, and also for emergency situation such as power failure.

\*2) When an operator is confined within a dangerous zone, the actuator can be unlocked manually by pressing the rear unlocking button. (rear unlocking button model)

### Operating Characteristics (Reference)

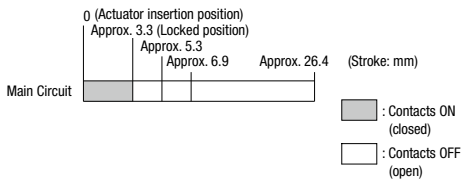

- The operation characteristics shown in the chart above are of the HS9Z-A51. For other actuators, add 1.3mm.
- See **E-051** for HS9Z-BA5.
- The operation characteristics show the contact status when the actuator enters the entry slot of an interlock switch.

HS6B

HS6E

HS5D

HS5L

HS1L

Actuators for HS1/HS5/HS6

Actuators/ Padlock Hasp

Actuators for HS5 Series Interlock Switches

Actuator

| Description                                       | Part No.  | Package Quantity | Remarks   |
|---|-----------|------------------|---|
| Straight  | HS9Z-A51  | 1                | Actuator retention force is Fzh=1400N.  |
| Straight with rubber bushings                     | HS9Z-A51A |                  |   |
| Right-angle                                       | HS9Z-A52  |                  |   |
| Right-angle with tubber bushings                  | HS9Z-A52A |                  |   |
| Angle adjustable (vertical)                       | HS9Z-A53  |                  |   |
| Angle adjustable (vertical/horizontal) with plate | HS9Z-A55S |                  |   |
| Angle adjustable (vertical/horizontal)            | HS9Z-A55  |                  | Actuator retention force is Fz=500N. When a retention force of 500N or more is required, use HS9Z-A55S. |

• See E-064 for details on actuators.

Accessories

| Description                      | Part No.                        | Package Quantity                           | Remarks  |  |
|----------------------------------|---------------------------------|--|--|--|
| Sliding actuator (*1)            | HS9Z-SH5                        | 1  | Actuator retention force is Fzh=1400N.                           |  |
| Door handle actuator (*1)        | Handle unit for right-hand door |  | HS9Z-DH5RH   | Choose according to the required opening side. |
|                                  | Handle unit for left-hand door  |  | HS9Z-DH5LH   |  |
|                                  | Switch cover unit               |  | HS9Z-DH5C  |  |
| Slide handle actuator            | HS9Z-EH5L                       |  | Used for installing the interlock switch inside.                 |  |
| Spring loaded actuator (*1) (*2) | HS9Z-BA5                        |  | Actuator retention force is Fzh=1400N.                           |  |
| Plug actuator (*1)               | HS9Z-A5P                        |  |  |  |
| Padlock hasp (*1)                | HS9Z-PH5                        |  |  |  |
| Mounting plate (*3)              | HS9Z-SP51                       |  | Used when installing the interlock switch on the aluminum frame. |  |
|                                  | HS9Z-FL53                       |  | Panel Thickness (*5) (X): $23 < X \leq 33$                       |  |
| Rear Unlocking Button Kit (*4)   | HS9Z-FL54                       | Panel Thickness (*5) (X): $33 < X \leq 43$ |  |  |
|                                  | HS9Z-FL55                       | Panel Thickness (*5) (X): $43 < X \leq 53$ |  |  |

\*1) See E-064 to E-090 for details on accessories.

\*2) HS9Z-BA5 can only be used for HS5L interlock switches. Also, HS9Z-BA5 can be used only on slide doors. Do not use on hinge doors.

\*3) When mounting HS5L-□□□□L (rear unlocking button model) using a mounting plate, provide mounting holes on the mounting plate as shown below and user Rear Unlocking Button Kit (HS9Z-FL5 □).

\*4) HS5L interlock switch rear unlocking button kit (When mounting HS5L-□L directly).

\*5) Thickness of the frame or panel where the HS5L is mounted.

• Follow the instructions on catalog or instruction sheet for proper use of accessories.

- APEM
- Switches & Pilot Lights
- Control Boxes
- Emergency Stop Switches
- Enabling Switches
- Safety Products
- Explosion Proof
- Terminal Blocks
- Relays & Sockets
- Circuit Protectors
- Power Supplies
- LED Illumination
- Controllers
- Operator Interfaces
- Sensors
- AUTO-ID
- Interlock Switches
- Non-contact Interlock Switches
- Safety Laser Scanners
- Safety Light Curtains
- Safety Modules
- HS6B
- HS6E
- HS5D
- HS5L
- HS1L
- Actuators for HS1/HS5/HS6
- Actuators/ Padlock Hasp

# HS5L Interlock Switches with Solenoid

## Interlock Switch Dimensions and Mounting Hole Layouts

### HS5L-□□4M-G

When using Horizontal Mounting/Straight Actuator (HS9Z-A51)

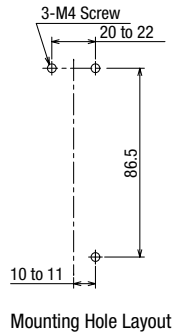
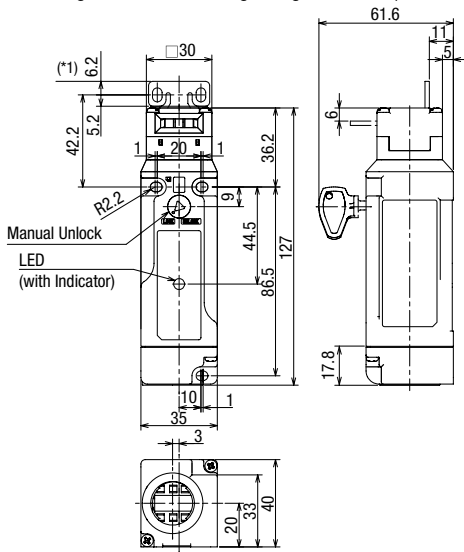

#### Accessories (supplied)

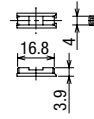

Slot Plug

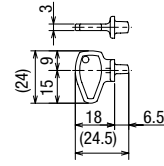

Manual Unlocking Key

### HS5L-□□4SM-G (two-conduit model)

When using Horizontal Mounting/Straight Actuator (HS9Z-A51)

Left cable orientation (factory setting)

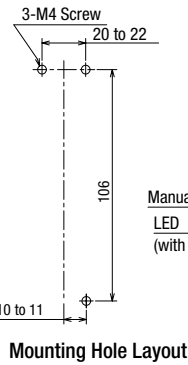
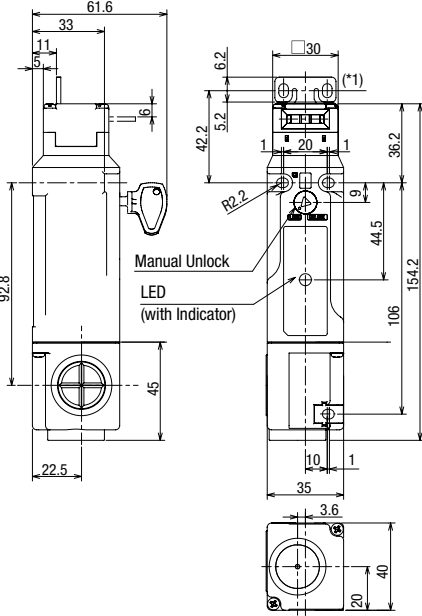

Right cable orientation

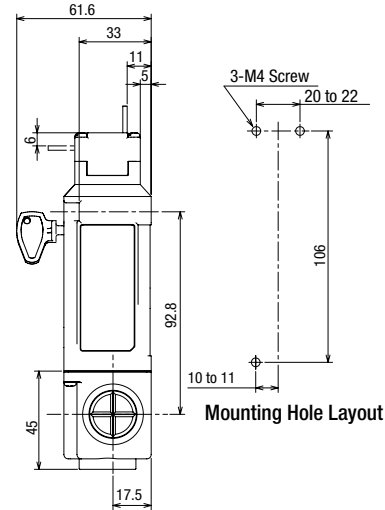
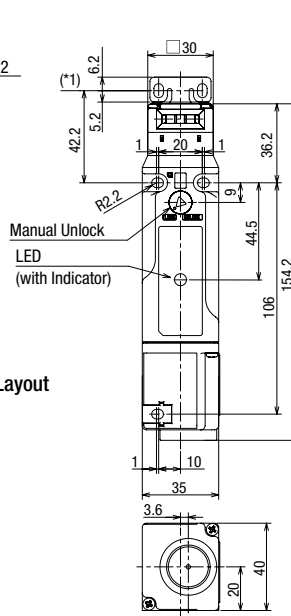

\*1) Actuator mounting reference position

- APEM
- Switches & Pilot Lights
- Control Boxes
- Emergency Stop Switches
- Enabling Switches
- Safety Products
- Explosion Proof
- Terminal Blocks
- Relays & Sockets
- Circuit Protectors
- Power Supplies
- LED Illumination
- Controllers
- Operator Interfaces
- Sensors
- AUTO-ID
- Interlock Switches
- Non-contact Interlock Switches
- Safety Laser Scanners
- Safety Light Curtains
- Safety Modules
- HS6B
- HS6E
- HS5D
- HS5L
- HS1L
- Actuators for HS1/HS5/HS6
- Actuators/ Padlock Hasp

Interlock Switch Dimensions and Mounting Hole Layouts

HS5L-□□4LM-G (with rear unlocking button)

When using Horizontal Mounting/Straight Actuator (HS9Z-A51)

All dimensions in mm.

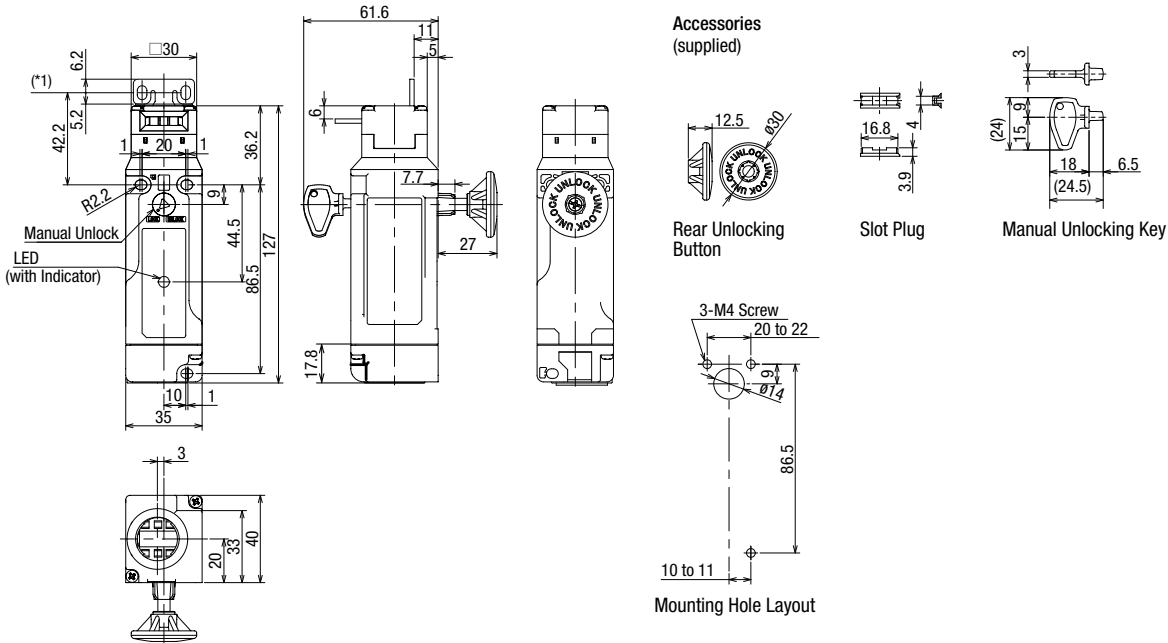

HS5L-□□4LSM-G (two-conduit model/rear unlocking button)

When using Horizontal Mounting/Straight Actuator (HS9Z-A51)

Left cable orientation (factory setting)

Right cable orientation

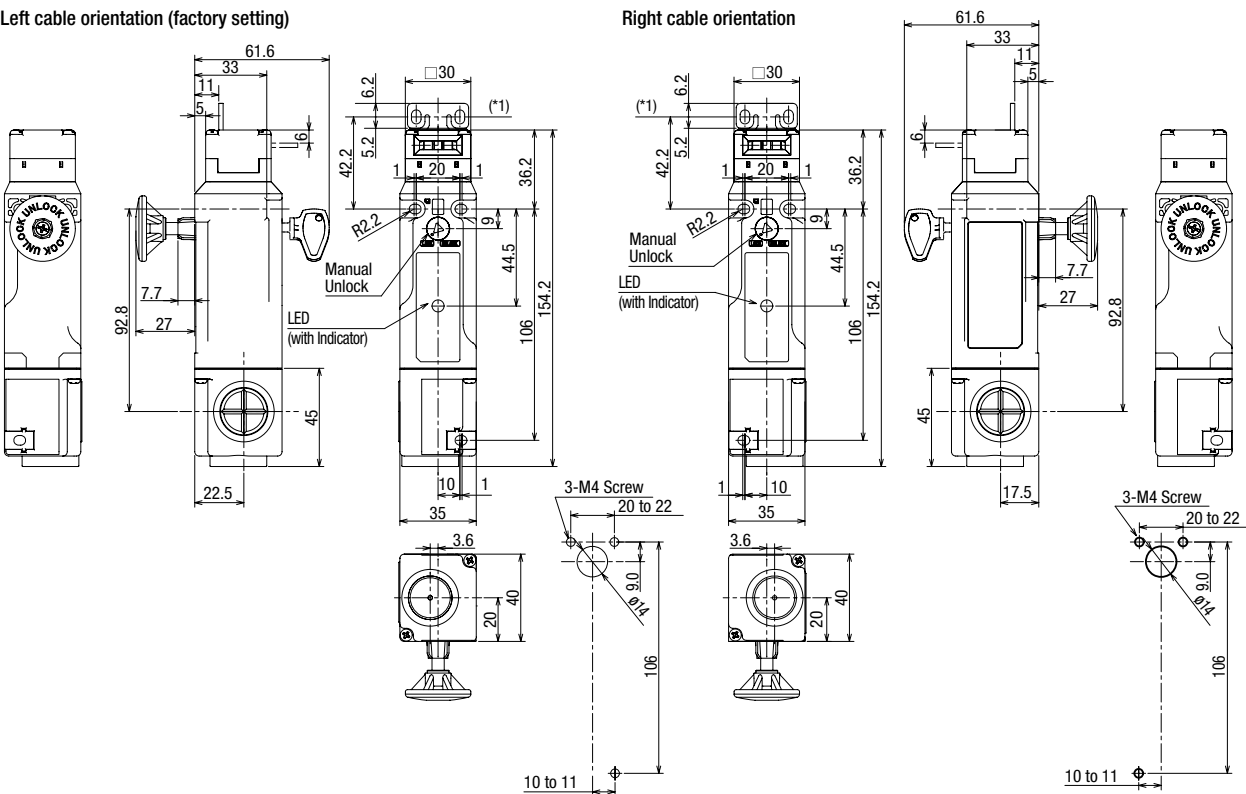

\*1) Actuator mounting reference position

- APEM
- Switches & Pilot Lights
- Control Boxes
- Emergency Stop Switches
- Enabling Switches
- Safety Products
- Explosion Proof
- Terminal Blocks
- Relays & Sockets
- Circuit Protectors
- Power Supplies
- LED Illumination
- Controllers
- Operator Interfaces
- Sensors
- AUTO-ID

- Interlock Switches
- Non-contact Interlock Switches
- Safety Laser Scanners
- Safety Light Curtains
- Safety Modules

HS6B

HS6E

HS5D

HS5L

HS1L

Actuators for HS1/HS5/HS6  
 Actuators/ Padlock Hasp



# HS5L Interlock Switches with Solenoid

## Interlock Switch Dimensions and Mounting Hole Layouts

### Dimensions

All dimensions in mm.

#### Rear Unlocking Button Kit (HS9Z-FL5□)

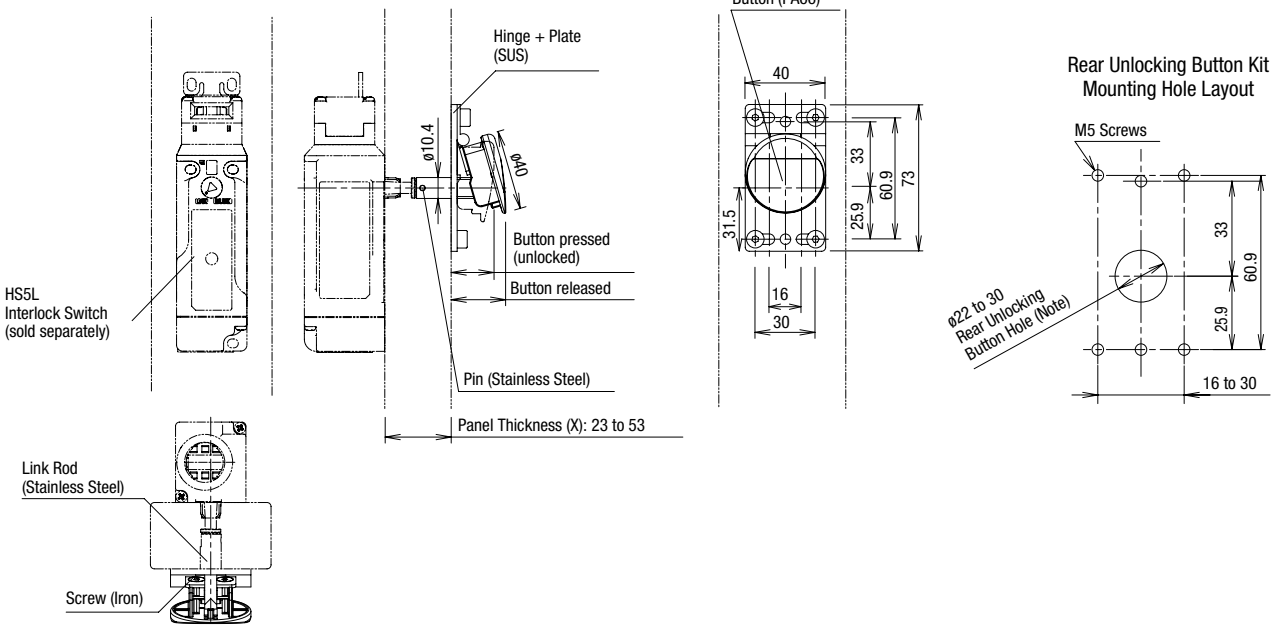

#### Mounting Plate (HS9Z-SP51)

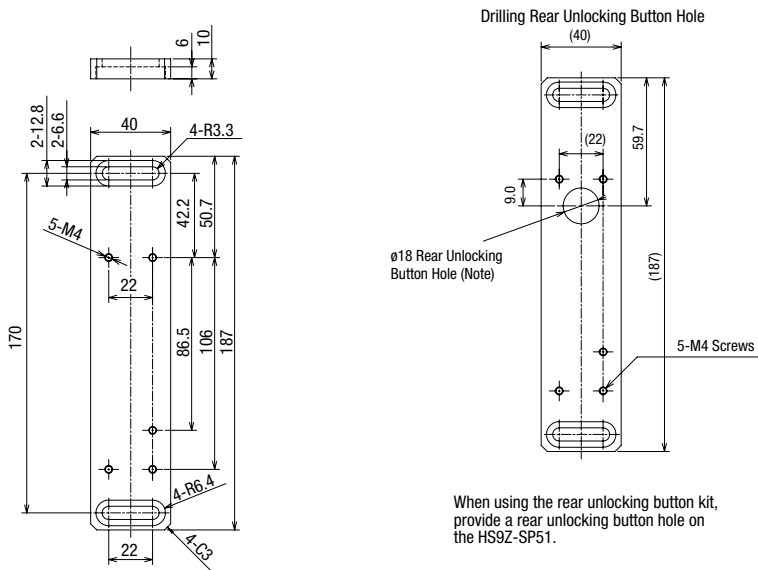

When using the rear unlocking button kit, provide a rear unlocking button hole on the HS9Z-SP51.

Note: With the mounting hole dimension, the rear unlocking button rod does not touch the mounting hole even when the interlock switch moves sideways.

APEM

Switches & Pilot Lights

Control Boxes

Emergency Stop Switches

Enabling Switches

Safety Products

Explosion Proof

Terminal Blocks

Relays & Sockets

Circuit Protectors

Power Supplies

LED Illumination

Controllers

Operator Interfaces

Sensors

AUTO-ID

Interlock Switches

Non-contact Interlock Switches

Safety Laser Scanners

Safety Light Curtains

Safety Modules

HS6B

HS6E

HS5D

HS5L

HS1L

Actuators for HS1/HS5/HS6

Actuators/ Padlock Hasp

## ⚠ Safety Precautions

- In order to avoid electric shock or fire, turn power off before installation, removal, wiring, maintenance, or inspection of the interlock switch.
- If relays are used in the circuit between the interlock switch and the load, use only safety relays, since welded or sticking contacts of standard relays may invalidate the functions of the interlock switch. Perform a risk assessment and make a safety circuit which satisfies the requirements of the safety category.
- Do not place a PLC in the circuit between the interlock switch and the load. Safety security can be endangered in the event of a malfunction of the PLC.
- Do not disassemble or modify the interlock switch, otherwise a malfunction or an accident may occur.
- Do not install the actuator in a location where a human body may come into contact. Otherwise injury may occur.
- Solenoid lock is locked when energized, and unlocked when de-energized. When energization is interrupted due to wire disconnection or other failures, the interlock switch may be unlocked causing possible danger to the operators. Solenoid lock must not be used in applications where locking is strictly required for safety. Perform a risk assessment and determine whether solenoid lock is appropriate.
- When changing the head orientation, disconnect the cable and turn the manual unlock to the UNLOCK position in advance. If the head orientation is changed when the cable is connected and the manual unlock is in the LOCK position, machines may start to operate, causing danger to the operators.

- HS5L interlock switches are Type 2 low level coded interlocking devices (ISO14119). According to ISO14119, the following is required to minimize defeat when installing and constructing systems:

1. Prevent dismantling or de-positioning of the elements of the interlocking device by use of non-detachable fixing (e.g. welding, gluing, one-way screws, riveting). However, use of non-detachable fixing can be an inappropriate solution in cases where a failure of the interlocking device during lifetime of the machinery can be expected and a fast change is necessary. In this case measures mentioned below, should be used to provide the required level of risk reduction.
2. Apply at least one out of the four measures below.
  - ① Mounting out of reach.
  - ② Physical obstruction or shielding.
  - ③ Mounting in hidden position.
  - ④ Integration of defeat monitoring by means of status monitoring/cyclic testing.

## Instructions

- Do not use the interlock switch as a door stop. Install a mechanical door stop at the end of the door to protect the interlock switch against excessive force.
- Do not apply excessive shock to the interlock switch when opening or closing the door. A shock to the interlock switch exceeding 1,000m/s<sup>2</sup> may cause damage to the interlock switch.
- Prevent foreign objects such as dust and liquids from entering the interlock switch while connecting a conduit or wiring.
- Plug the unused actuator entry slot using the slot plug supplied with the interlock switch.
- Do not store the interlock switches in a dusty, humid, or organic-gas atmosphere, or in an area subjected to direct sunlight.
- Use proprietary actuators only. When other actuators are used, the interlock switch may be damaged.
- The locking strength is rated at 1400N. Do not apply a load higher than the rated value. When a higher load is expected, provide an additional system consisting of another interlock switch without lock (such as the HS5D interlock switch) or a sensor to detect door opening and stop the machine.
- Regardless of door types, do not use the interlock switch as a door lock. Install a separate lock using a latch or other measures.
- While the solenoid is energized, the switch temperature rises approximately 40°C above the ambient temperature (to approximately 95°C while the ambient temperature is 55°C). To prevent burns, avoid touching. If cables come into contact with the switch, use heat-resistant cables.
- Although the HS9Z-A51A/A52A actuators alleviate shock when the actuator enters a slot in the interlock switch, make sure that excessive shock is not applied. If the Rubber Bushings become deformed or cracked, replace with new ones.

## Mounting Examples

Refer to the following drawing for the installation. Mount the interlock switch to a fixed machine or guard, and actuator on the hinged door. Do not mount both interlock switch and actuator on the hinged doors. This may result in the actuator being inserted at a wrong angle to the interlock switch, resulting in malfunction.

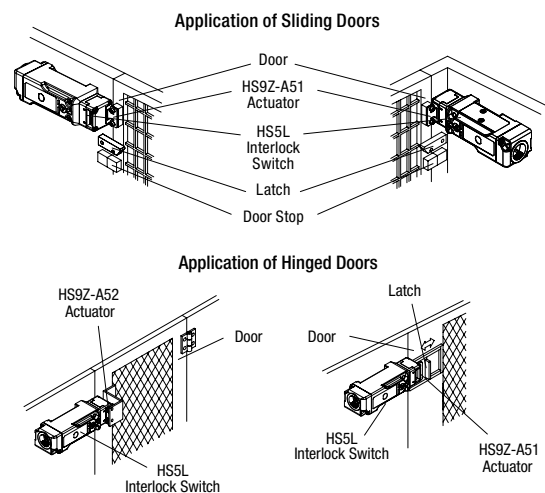

# HS5L Interlock Switches with Solenoid

## Instructions

### Minimum Radius of Hinged Door

When using the interlock switch for a hinged door, refer to the minimum radius of doors shown below. Especially for doors with a small turning radius, use vertical/horizontal movable actuators (HS9Z-A53/A55).

Note: Because deviation or dislocation of a hinged door may occur in actual applications, make sure of the correct operation by installing the actual machine first before use.

### HS9Z-A52 Actuator

When the center of the hinged door is used as the reference for the interlock switch contact surface:

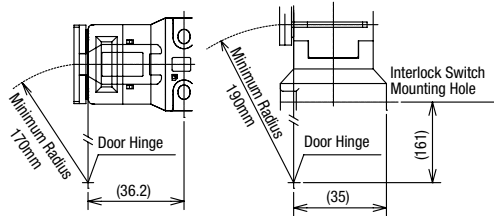

When the center of the hinged door is used as the reference for the actuator mounting surface:

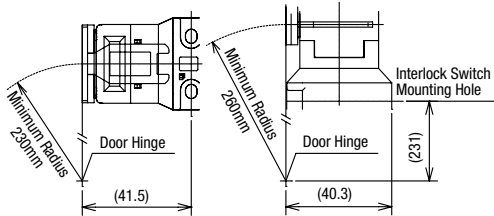

### HS9Z-A52A Actuator (with Rubber Bushings)

When the center of the hinged door is used as the reference for the interlock switch contact surface:

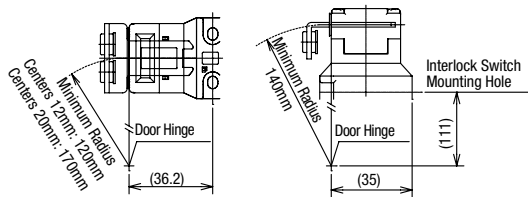

When the center of the hinged door is used as the reference for the actuator mounting surface:

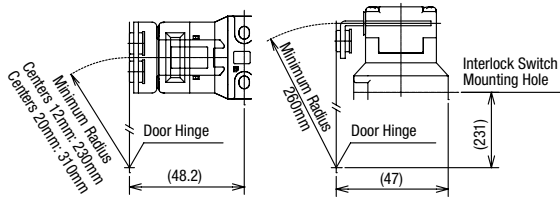

### Actuator Angle Adjustment (vertical/horizontal)

- Using the angle adjustment screw, the actuator angle can be adjusted (refer to the dimensional drawing on E-064 to E-070). Adjustable angle: 0 to 20°
- The larger the adjusted angle of the actuator, the smaller the applicable radius of the door opening. After installing the actuator, open the door. Then adjust the actuator so that its edge can be inserted properly into the actuator entry slot of the interlock switch.
- After adjusting the actuator angle, apply Loctite to the adjustment screw so that the screw will not move.

### When using the HS9Z-A55S Angle Adjustable (vertical/horizontal) Actuator (w/Plate)

- When the center of the hinged door is used as the reference for the interlock switch contact surface: 50mm
- When the center of the hinged door is used as the reference for the actuator mounting surface: 70mm
- The HS9Z-A55S angle adjustable actuator is made of glass-reinforced PA66 (66 nylon) and the angle adjustment screw and plate are made of stainless steel. When using the screw locking agent, make sure that it is compatible with the base material.

When the center of the hinged door is used as the reference for the interlock switch contact surface:

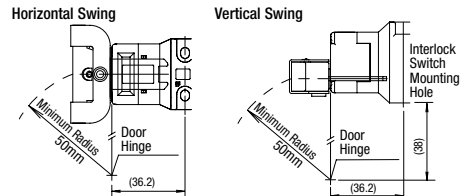

When the center of the hinged door is used as the reference for the actuator mounting surface:

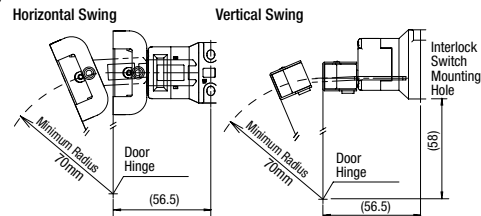

### When using the HS9Z-A55 Angle Adjustable (vertical/horizontal) Actuator

- When the center of the hinged door is used as the reference for the interlock switch contact surface: 50mm
- When the center of the hinged door is used as the reference for the actuator mounting surface: 70mm
- The HS9Z-A55 angle adjustable actuator is made of glass-reinforced PA66 (66 nylon) and the angle adjustment screw is stainless steel. When using the screw locking agent, make sure that it is compatible with the base material.

When the center of the hinged door is used as the reference for the interlock switch contact surface:

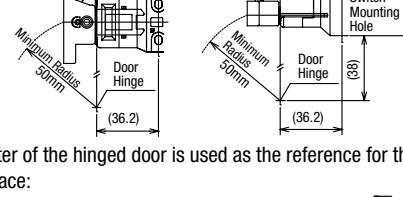

When the center of the hinged door is used as the reference for the actuator mounting surface:

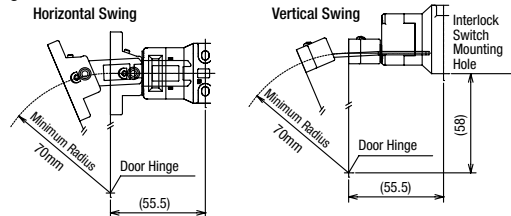

### When using the HS9Z-A53 Angle Adjustable (vertical) Actuator

- When the center of the hinged door is used as the reference for the interlock switch contact surface: 50mm
- When the center of the hinged door is used as the reference for the actuator mounting surface: 80mm
- Angle adjustment screw recommended tightening torque: 0.8N·m.

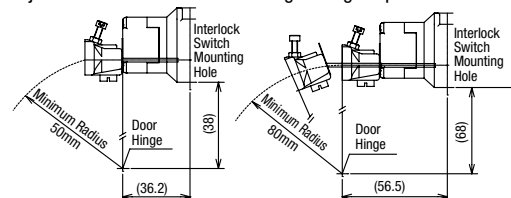

|                                |
|--------------------------------|
| APEM                           |
| Switches & Pilot Lights        |
| Control Boxes                  |
| Emergency Stop Switches        |
| Enabling Switches              |
| Safety Products                |
| Explosion Proof                |
| Terminal Blocks                |
| Relays & Sockets               |
| Circuit Protectors             |
| Power Supplies                 |
| LED Illumination               |
| Controllers                    |
| Operator Interfaces            |
| Sensors                        |
| AUTO-ID                        |
| Interlock Switches             |
| Non-contact Interlock Switches |
| Safety Laser Scanners          |
| Safety Light Curtains          |
| Safety Modules                 |
| HS6B                           |
| HS6E                           |
| HS5D                           |
| HS5L                           |
| HS1L                           |
| Actuators for HS1/HS5/HS6      |
| Actuators/ Padlock Hasp        |

APEM

Switches & Pilot Lights

Control Boxes

Emergency Stop Switches

Enabling Switches

Safety Products

Explosion Proof

Terminal Blocks

Relays & Sockets

Circuit Protectors

Power Supplies

LED Illumination

Controllers

Operator Interfaces

Sensors

AUTO-ID

Interlock Switches

Non-contact Interlock Switches

Safety Laser Scanners

Safety Light Curtains

Safety Modules

HS6B

HS6E

HS5D

HS5L

HS1L

Actuators for HS1/HS5/HS6

Actuators/ Padlock Hasp

## Instructions

### Installing the Head

Do not use plastic and metallic heads of HS5D interlock switches on the HS5L. Be sure to use HS5L metallic heads.

\* The metal heads of the HS5D and HS5L look similar. When using these interlock switches adjacently, ensure that the heads are not interchanged.

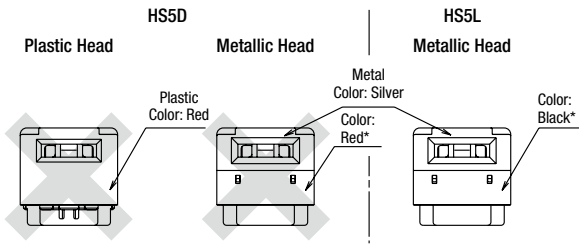

\* The metal head can be distinguished easily by the color of the plastic.

### Rotating the Head

The head can be rotated by removing the four screws from the corners of the head and reinstalling the head in the desired orientation. However, when changing the mounting direction of the head after wiring, turn the manual lock release to the "UNLOCK" position using the enclosed manual lock release key first. When reinstalling the head, make sure that no foreign object enters the interlock switch. Tighten the screws tightly, without leaving a space between the head and body, otherwise the interlock switch may malfunction. (Recommended tightening torque: 0.9 to 1.1 N·m)

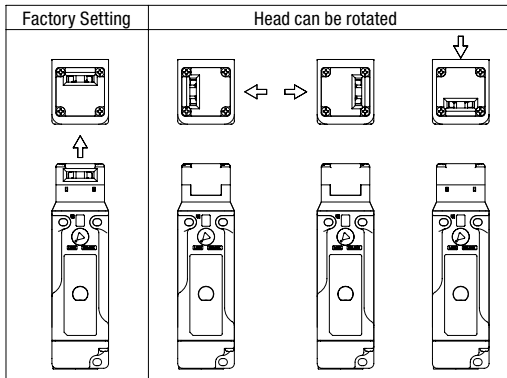

### Head Removal Detection Function

- Solenoid locks interlock switches are not equipped with the head removal detection function.
- The head removal detection function is available only on spring lock interlock switches with circuits VB, VD, and DD having two or more lock monitor circuits. Removing the head will result in disparity (41-42: OFF, 51-52: ON). Note that this function cannot be detected with other models.
- Only the lock monitor circuit 41-42 turns off (open) when the head is removed, such as when the head is rotated. The other monitor circuit 51-52 turns ON (close). Be sure to connect the lock monitor circuit (41-42) to a safety circuit.

### Spring Loaded Actuator

- When using the actuator, be careful of protruding ends.
- Regardless of door types, do not use the HS9Z-BA5 actuator as a door lock or a door stop.
- When an operator enters the hazardous zone, take safety measures such as using a HS9Z-PH5 padlock hasp so that the operator is not trapped inside and the machine cannot start by mistake.
- Use the actuator only on sliding doors. Do not use on hinged doors.
- As shown in the figure on the right, do not insert the sliding actuator from below. The actuator may fall out due to shocks.

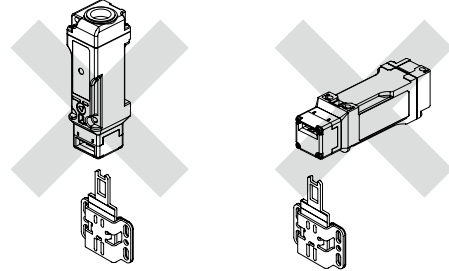

- The HS9Z-BA5 actuator can only be used for HS5L interlock switches. Do not use the HS9Z-BA5 actuator for other products.
- Do not modify or disassemble the actuator.

### Installation (when installation reference is 0.8mm)

- The actuator protrudes out when the actuator is not inserted (door is open) as shown in 1. in the drawing.
- The mounting reference position can be set to 0.8mm when the actuator is fully inserted and the actuator protrudes up to the 0.8mm line.

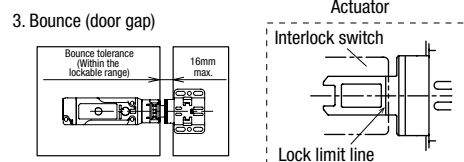
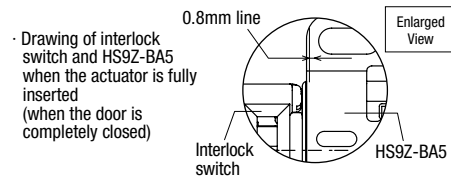
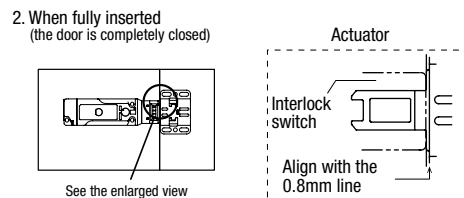
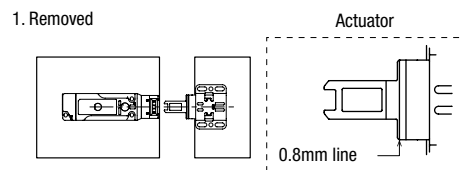

## Instructions

## Adjustment

## Adjustment Procedure

1. Make a hole at A or C.
2. Fasten temporarily with screws, and check the actuator position.
3. Make a hole at B and fix the actuator using a screw or a rivet.

## • 3.3mm line

The mounting reference position is where the door is fully closed, and there is a 0.8mm space between the safety switch and HS9Z-BA5, but can be adjusted up to the 3.3mm line.

The actuator is most securely locked when the mounting reference position is at the 0.8mm line. However, adjust between 0.8 to 3.3mm if the interlock switch is mounted on a door where the space might become smaller.

## • Lock limit line

When a door opens by bouncing, if the lock limit line is outside of the edge of the interlock switch, the force of the bounce may be too large so that the door may not lock.

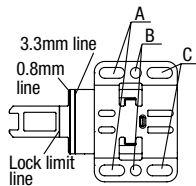

## Safety Precautions

- The maximum gap of the door that can be locked is 16mm. (When mounting reference is at the 0.8mm line)
- If the safety distance and minimum gap does not satisfy the requirements of ISO13857, make the gap smaller by overlapping the doors or by providing sufficient distance from the hazardous source. If the required safety distance cannot be obtained, use the actuator other than spring loaded actuator.
- The operating characteristics may change when the actuator is used with the HS5L. Check the operating characteristics before use.

## Characteristic Diagram (Reference)

When the mounting reference is at the 0.8mm line:

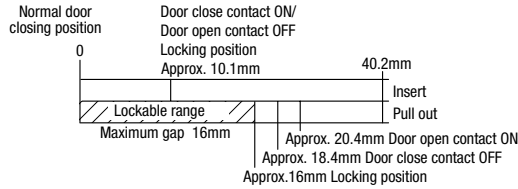

\* Bounce can be tolerated to approximately 16mm.

[Reference] When using HS9Z-A51A with HS5L interlock switch:

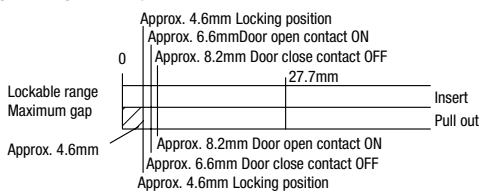

## Manual Unlocking

## Spring lock

The spring lock interlock switch allows manual unlocking of the actuator to precheck proper door movement before wiring or turning power on, as well as for emergency use such as a power failure.

## Solenoid lock

The solenoid interlock switch does not unlock even when the solenoid is de-energized. However, the interlock switch can be unlocked manually in emergency cases.

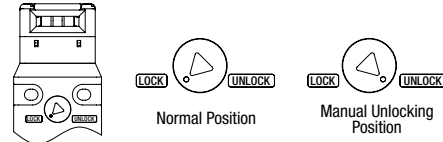

When locking or unlocking the interlock switch manually, turn the key fully using the manual unlock key supplied with the interlock switch as shown above. Using the interlock switch with the key not fully turned (less than 90°) may cause damage to the interlock switch or operation failures (when manually unlocked, the interlock switch will keep the main circuit disconnected and the door unlocked).

Do not apply excessive force to the manual unlock, otherwise the manual unlock will become damaged. Do not leave the manual unlock key attached to the interlock switch during operation. This is dangerous because the interlock switch can always be unlocked while the machine is in operation.

## Safety Precautions

Before manually unlocking the interlock switch, make sure that the machine has come to a complete stop. Manual unlocking during operation may unlock the interlock switch before the machine stops, and the function of interlock switch with solenoid is lost.

## Installing the Rear Unlocking Button (HS5L-□L)

After installing the interlock switch on the panel, place the rear unlocking button (supplied with the switch) on the push rod on the back of the interlock switch, and fasten the button using M3 screws (supplied with the switch).

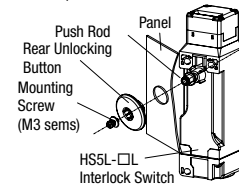

When installing on a mounting frame

thicker than 6mm, use the rear unlocking button kit HS9Z-FL5□ (sold separately).

## Safety Precautions

After installing the rear unlocking button, apply Loctite to the screw so that the screw does not become loose. The rod is made of stainless steel, the button is made of glass-reinforced PA66 (66 nylon) and the screw is made of iron. Take the compatibility of the plastic material and Loctite into consideration.

Instructions

Installing the Rear Unlocking Button Kit

1. Install the connecting rod onto the push rod on the HS5L-□L rear unlocking button interlock switch.
2. A pin is attached to the connecting rod. Insert the pin into the hole in the push rod, using pliers.

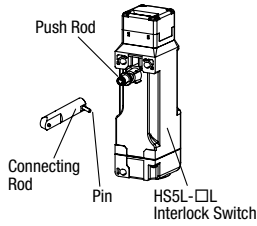

3. Pull the connecting rod from the hole in the mounting frame, and turn the button operating pin to the horizontal position.

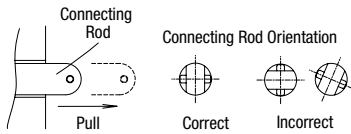

Safety Precautions

- Ensure that the connecting rod is pulled out completely and it is horizontal to the interlock switch, otherwise the unlocking button cannot be installed.  
Note: Frame must be supplied by the user.  
When using an HS9Z-SP51 mounting plate (sold separately) to install the HS5L on a frame, provide a hole for the connecting rod on the frame and mounting plate.

For the mounting hole layout of interlock switches, see dimensions on E-047.

4. Install the unlocking button on the connecting rod by fitting the pin to the grooves on the back of the button, and fasten the base plate on the mounting frame using the screws.

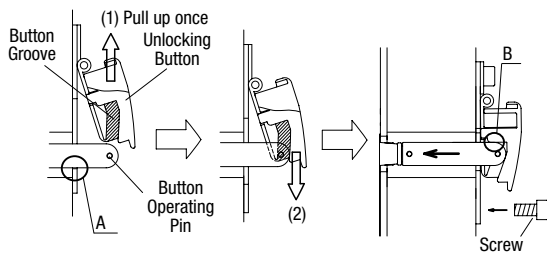

5. After fastening the screws, check if locking and unlocking operations can be performed.

Safety Precautions

- Install the rear unlocking button kit in the correct direction as shown below. Do not install the kit in incorrect directions, otherwise malfunction may occur.
- Do not apply strong force exceeding 100m/s<sup>2</sup> to the interlock switch while the rear unlocking button is not pressed, otherwise malfunction may occur.

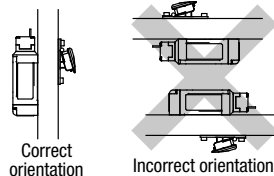

Unlocking the Manual Lock Using the Rear Unlocking Button

Use the rear unlocking button when a worker is locked inside a safety fence (hazard area). (Compliant with escape release described in ISO14119 [2003] and GS-ET-19)

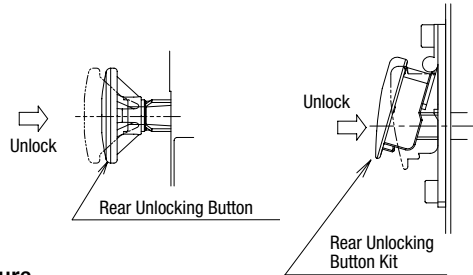

Procedure

- When the rear unlocking button is pressed, the interlock switch is unlocked and the door can be opened.
- To lock the interlock switch, pull back the button.
- When the button remains pressed, the interlock switch cannot be locked even if the door is closed, and the main circuit remains open.

Safety Precautions

- Install the rear unlocking button in the place where only the operator inside the hazardous area can use it. Do not install the button in a place where an operator outside the hazardous area can use it, otherwise the interlock switch can be unlocked during usual machine operation, causing danger.
- Operate the rear unlocking button by hand only. Do not operate using a tool or with excessive force. Do not apply force to the button from the direction other than the proper direction, otherwise the button will be damaged.

Recommended Tightening Torque

- HS5L interlock switch: 1.8 to 2.2 N·m (M4 screws × 3)\*
- Lid mounting screw: 0.5 to 0.7 N·m (M3 screw × 2)
- Rear unlocking button: 0.5 to 0.7 N·m (M3 screw)
- Rear unlocking button kit: 4.8 to 5.2 N·m (M5 screw)
- Actuators
  - HS9Z-A51: 1.8 to 2.2 N·m (M4 screws × 2)\*
  - HS9Z-A52: 0.8 to 1.2 N·m (M4 flat head screws × 2)
  - HS9Z-A51A/A52A: 1.0 to 1.5 N·m (M4 screws × 2)\*
  - HS9Z-A53: 4.5 to 5.5 N·m (M6 screws × 2)\*
  - HS9Z-A55: 1.0 to 1.5 N·m (M4 screws × 2)\*
  - HS9Z-A55S: 1.0 to 1.5 N·m (M4 screws × 2)\*
  - HS9Z-BA5: 4.5 to 5.5 N·m (M5 screws × 2/4)\*

\* If the mounting screw recommended tightening torque values above is not satisfied, check loosening after installation thoroughly.

- Mounting screws need to be prepared by the customer.
- To avoid unauthorized or unintended removal of the interlock switch and the actuator, it is recommended that the interlock switch and actuator are installed in a secure manner, for example using special screws or welding the screws (ISO14119).
- When installing the HS9Z-A51A and HS9Z-A52A actuators, use the washer (supplied with the actuator) on the hinged door, and mount tightly using two M4 screws.  
Mounting centers: 12mm (factory setting), adjustable to 20mm

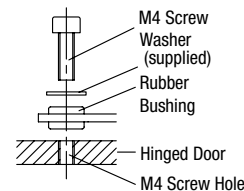

|                         |
|-------------------------|
| APEM                    |
| Switches & Pilot Lights |
| Control Boxes           |
| Emergency Stop Switches |
| Enabling Switches       |
| Safety Products         |
| Explosion Proof         |
| Terminal Blocks         |
| Relays & Sockets        |
| Circuit Protectors      |
| Power Supplies          |
| LED Illumination        |
| Controllers             |
| Operator Interfaces     |
| Sensors                 |
| AUTO-ID                 |

|                                |
|--------------------------------|
| Interlock Switches             |
| Non-contact Interlock Switches |
| Safety Laser Scanners          |
| Safety Light Curtains          |
| Safety Modules                 |

|      |
|------|
| HS6B |
| HS6E |
| HS5D |
| HS5L |

|                           |
|---------------------------|
| HS1L                      |
| Actuators for HS1/HS5/HS6 |
| Actuators/ Padlock Hasp   |

## HS5L Interlock Switches with Solenoid

## Instructions

## Applicable Cable Glands

Use a cable gland with IP67 protection degree.

## Applicable Cable Gland Dimensions

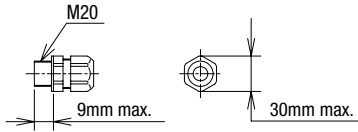

## When Using Flexible Conduits (example)

| Conduit Port Size | Plastic Cable Gland | Metal Cable Gland        |
|-------------------|---------------------|--------------------------|
| M20               | —                   | RLC-103EC20 (Nihon Flex) |

## When Using Multi-core Cables (example)

| Conduit Port Size | Plastic Cable Gland  | Metal Cable Gland          |
|-------------------|--|----------------------------|
| M20               | ST-M20X1.5*<br>(Manufacturer: LAPP)<br>(Distributor: K-MECS) | ALS-□□EC20<br>(Nihon Flex) |

Different cable glands are used depending on the cable sheath outside diameter. When purchasing a cable gland, confirm that the cable gland is applicable to the cable sheath outside diameter.

\* When using ST-M20X1.5, use with gasket below:  
GPM20 (Manufacturer: LAPP Distributor: K.MECS)

## Lead-in Wire Length and Wiring Examples

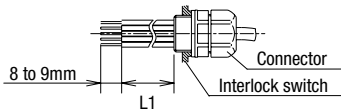

| Part No.                      | Cable Orientation    | Cable Length (L1)        |
|-------------------------------|----------------------|--------------------------|
| HS5L-□□4M-G<br>HS5L-□□4LM-G   | Straight             | 30 to 35mm               |
| HS5L-□□4SM-G<br>HS5L-□□4LSM-G | Side (right or left) | 50 to 55mm<br>40 to 45mm |

## Terminal wiring diagram

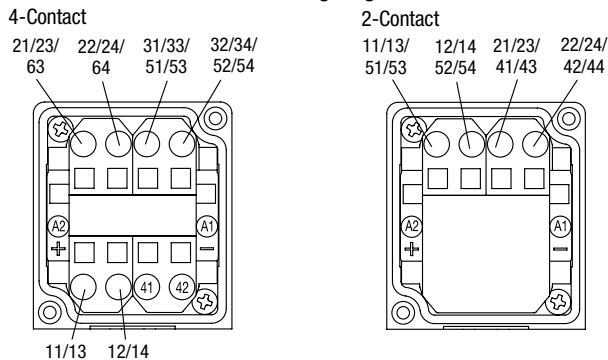

## Notes:

When connecting the NC contact (11-12, 21-22) of door monitor circuit and NC contacts (41-42, 51-52) of the lock monitor circuit in a series as an input to a safety circuit, connect 12-41 or 22-51.

## Cautions for Wiring

Use the following applicable wiring. Stranded wire or solid wire (1 wire): 0.3 to 1.5mm<sup>2</sup> (AWG22 to AWG16)

Make sure to strip the wire insulation 8 to 9mm from the end. If the strip length is too short, the wire may fall out. If the strip length is too long, it may short circuit with other wires.

Twist the wires and make sure that there are no wire whiskers.

When using stranded wires without ferrules, make sure that the core wires have not been loosened.

- For wiring, use screwdrivers as shown in the right. (The shape of the tip of the screwdriver is in accordance with DIN5264)
- The inserting port of the wire and screwdriver, and direction of the tip is as shown in the diagram below.

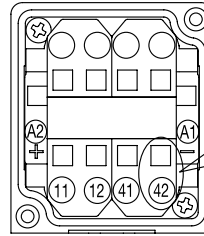
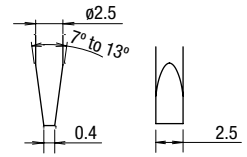

Screwdriver port and direction of the screwdriver tip.  
Wire port

- When using ferrules for stranded wires, use the ferrule listed in the following table.

| Compatible Wire     |       | Model No.  | Manufacturer      |
|---------------------|-------|------------|-------------------|
| 0.34mm <sup>2</sup> | AWG22 | AIO.34-6TQ | Phoenix Contact   |
| 0.5mm <sup>2</sup>  | AWG20 | AIO.5-6WH  |                   |
| 0.75mm <sup>2</sup> | AWG18 | AIO.75-6GY |                   |
| 1mm <sup>2</sup>    | AWG18 | AI1-6RD    |                   |
| 0.5mm <sup>2</sup>  | AWG20 | TE0.5-8    | NICHIFU Co., Ltd. |
| 0.75mm <sup>2</sup> | AWG18 | TE0.75-8   |                   |
| 1mm <sup>2</sup>    | AWG18 | TE1.0-8    |                   |

## Wire connection method

- Insert the screwdriver into the square-shaped port from a slightly slanted angle as shown, until the screw-driver tip touches the bottom of the spring. Make sure that the direction of the blade edge is correct.
- Push in the screwdriver until it touches the bottom of the port. The wire port is opened, and the screwdriver is held in place. The screwdriver will not come off even if you release your hand.
- While the screwdriver is retained in the port, insert the wire or ferrule into the round-shaped wire port.
- Pull out the screwdriver.  
The connection is now complete.

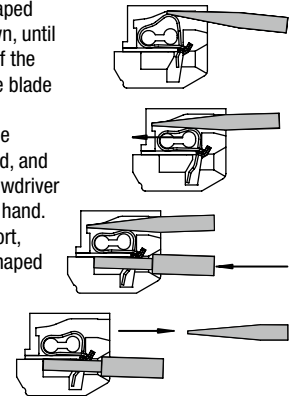

## Safety Precautions

When using wires with insulation diameter of  $\phi 2.0$ mm or less, do not insert the wire too deeply where the insulation inserts into the spring clamp opening. Make sure that the wire insulation is stripped 8 to 9mm and the wire is inserted to the bottom.

If there is a need to insert the screwdriver while holding the interlock switch with hands, be careful not to injure your fingers with the tip of the screwdriver. Connect one wire to one wiring port.

(According to IEC 60204 (JIS 9960-1) 13.1.1 General Requirement)

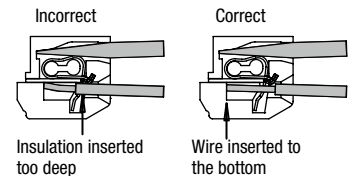

Instructions

Changing the cable orientation  
(two-conduit model)

Cable orientation can be changed on two-conduit models (HS5L-□□4SM-G/HS5L-□□4LSM-G). Straight, left, and right orientation is available.

When shipped, the terminal cover is installed on the HS5L for straight or left cable orientation.

See below for mounting the cable rightward.

- ① Remove the cover mounting screws (M3×2) and remove the HS5L from the cover.
- ② Rotate the cover 180°.
- ③ Re-intall the cover on the HS5L and fasten using the cover mounting screws.

Note: Before tightening the cover mounting screws, slide the spacer in the direction opposite the screw positions to prevent it from coming into contact with the screwdriver.

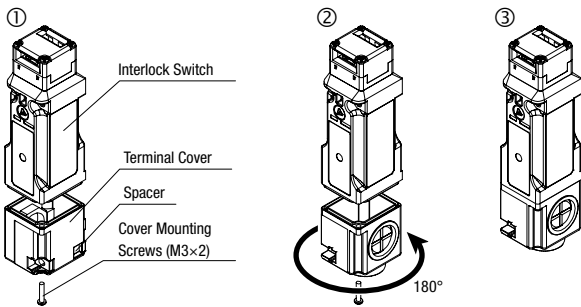

Opening conduit port

- Before use, knock out the conduit port where the connector is to be connected, using a tool such as screwdriver as shown in the figures.
- Before opening the conduit port, remove the terminal cover from the HS5L, and remove the locking ring for the cable gland installed in the terminal cover.
- Be sure to remove any cracks or burrs on the conduit port, as it will impair waterproof performance.

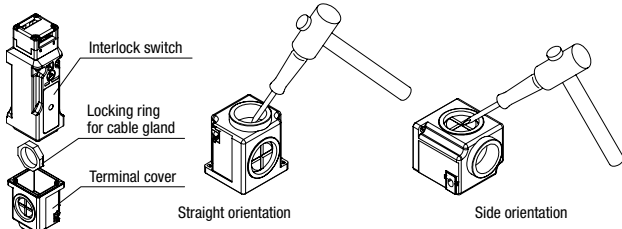

Connector Wiring

Perform wiring according to following procedures ① to ②.

- ① Insert the cable into the connector. Leave A and B untightened.
- ② Open the cover and insert the cable into the cover.

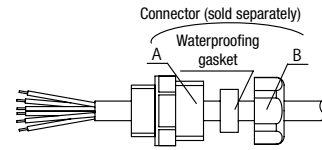

- ③ Wire to the terminals.
- ④ Tighten in the order of A → Cover → B.

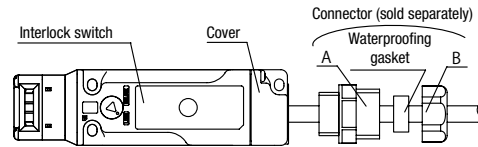

\* To remove the wiring, turn the power off and then unwire in the order of B → cover (→waterproof gasket → A).

Note: When removing A, because the waterproofing gasket is tightly attached to the cable, pull out the gasket carefully with tweezers so that the gasket is not damaged before loosening A. Otherwise, the cable will rotate together with A when loosened, and might break due to excessive twisting. Also, when reassembling, place the gasket in the original position first.

Safety Precautions

- When opening the cover, be careful not to lose the cover mounting screw.
- When tightening connector B, insert the cable into the connector, and set it to a position where the gasket of the connector holds the cable sheath, otherwise, its waterproof performance might be impaired.
- Tighten the connector in order of A → B. If connector B is tightened first, the wiring connected to the spring clamp terminal may become twisted when tightening A, causing disconnection or malfunction.
- Tighten the connectors with tightening torque according to the torque value recommended by the connector manufacturer. Otherwise, waterproof performance might be impaired.
- Do not exert excessive load, pressure, or tensile force on the cable, otherwise, disconnection or malfunction might occur.

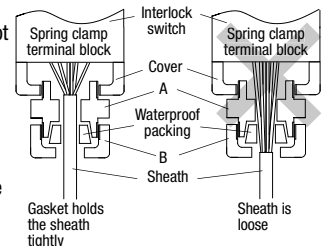

Make sure that the entire bore surface of the gasket is in contact with the sheath.

APEM

Switches & Pilot Lights

Control Boxes

Emergency Stop Switches

Enabling Switches

Safety Products

Explosion Proof

Terminal Blocks

Relays & Sockets

Circuit Protectors

Power Supplies

LED Illumination

Controllers

Operator Interfaces

Sensors

AUTO-ID

Interlock Switches

Non-contact Interlock Switches

Safety Laser Scanners

Safety Light Curtains

Safety Modules

HS6B

HS6E

HS5D

HS5L

HS1L

Actuators for HS1/HS5/HS6

Actuators/ Padlock Hasp



# Ordering Terms and Conditions

Thank you for using IDEC Products.

By purchasing products listed in our catalogs, datasheets, and the like (hereinafter referred to as "Catalogs") you agree to be bound by these terms and conditions. Please read and agree to the terms and conditions before placing your order.

## 1. Notes on contents of Catalogs

- (1) Rated values, performance values, and specification values of IDEC products listed in this Catalog are values acquired under respective conditions in independent testing, and do not guarantee values gained in combined conditions.  
Also, durability varies depending on the usage environment and usage conditions.
- (2) Reference data and reference values listed in Catalogs are for reference purposes only, and do not guarantee that the product will always operate appropriately in that range.
- (3) The specifications / appearance and accessories of IDEC products listed in Catalogs are subject to change or termination of sales without notice, for improvement or other reasons.
- (4) The content of Catalogs is subject to change without notice.

## 2. Note on applications

- (1) If using IDEC products in combination with other products, confirm the applicable laws / regulations and standards.  
Also, confirm that IDEC products are compatible with your systems, machines, devices, and the like by using under the actual conditions. IDEC shall bear no liability whatsoever regarding the compatibility with IDEC products.
- (2) The usage examples and application examples listed in Catalogs are for reference purposes only. Therefore, when introducing a product, confirm the performance and safety of the instruments, devices, and the like before use. Furthermore, regarding these examples, IDEC does not grant license to use IDEC products to you, and IDEC offers no warranties regarding the ownership of intellectual property rights or non-infringement upon the intellectual property rights of third parties.
- (3) When using IDEC products, be cautious when implementing the following.
  - i. Use of IDEC products with sufficient allowance for rating and performance
  - ii. Safety design, including redundant design and malfunction prevention design that prevents other danger and damage even in the event that an IDEC product fails
  - iii. Wiring and installation that ensures the IDEC product used in your system, machine, device, or the like can perform and function according to its specifications
- (4) Continuing to use an IDEC product even after the performance has deteriorated can result in abnormal heat, smoke, fires, and the like due to insulation deterioration or the like. Perform periodic maintenance for IDEC products and the systems, machines, devices, and the like in which they are used.
- (5) IDEC products are developed and manufactured as general-purpose products for general industrial products. They are not intended for use in the following applications, and in the event that you use an IDEC product for these applications, unless otherwise agreed upon between you and IDEC, IDEC shall provide no guarantees whatsoever regarding IDEC products.
  - i. Use in applications that require a high degree of safety, including nuclear power control equipment, transportation equipment (railroads / airplanes / ships / vehicles / vehicle instruments, etc.), equipment for use in outer space, elevating equipment, medical instruments, safety devices, or any other equipment, instruments, or the like that could endanger life or human health
  - ii. Use in applications that require a high degree of reliability, such as provision systems for gas / waterworks / electricity, etc., systems that operate continuously for 24 hours, and settlement systems
  - iii. Use in applications where the product may be handled or used deviating from the specifications or conditions / environment listed in the Catalogs, such as equipment used outdoors or applications in environments subject to chemical pollution or electromagnetic interference  
If you would like to use IDEC products in the above applications, be sure to consult with an IDEC sales representative.

## 3. Inspections

We ask that you implement inspections for IDEC products you purchase without delay, as well as thoroughly keep in mind management/maintenance regarding handling of the product before and during the inspection.

## 4. Warranty

- (1) Warranty period  
The warranty period for IDEC products shall be one (1) year after purchase or delivery to the specified location. However, this shall not apply in cases where there is a different specification in the Catalogs or there is another agreement in place between you and IDEC.
- (2) Warranty scope  
Should a failure occur in an IDEC product during the above warranty period for reasons attributable to IDEC, then IDEC shall replace or repair that product, free of charge, at the purchase location / delivery location of the product, or an IDEC service base. However, failures caused by the following reasons shall be deemed outside the scope of this warranty.
  - i. The product was handled or used deviating from the conditions / environment listed in the Catalogs
  - ii. The failure was caused by reasons other than an IDEC product
  - iii. Modification or repair was performed by a party other than IDEC
  - iv. The failure was caused by a software program of a party other than IDEC
  - v. The product was used outside of its original purpose
  - vi. Replacement of maintenance parts, installation of accessories, or the like was not performed properly in accordance with the user's manual and Catalogs
  - vii. The failure could not have been predicted with the scientific and technical standards at the time when the product was shipped from IDEC
  - viii. The failure was due to other causes not attributable to IDEC (including cases of force majeure such as natural disasters and other disasters)Furthermore, the warranty described here refers to a warranty on the IDEC product as a unit, and damages induced by the failure of an IDEC product are excluded from this warranty.

## 5. Limitation of liability

The warranty listed in this Agreement is the full and complete warranty for IDEC products, and IDEC shall bear no liability whatsoever regarding special damages, indirect damages, incidental damages, or passive damages that occurred due to an IDEC product.

## 6. Service scope

The prices of IDEC products do not include the cost of services, such as dispatching technicians. Therefore, separate fees are required in the following cases.

- (1) Instructions for installation / adjustment and accompaniment at test operation (including creating application software and testing operation, etc.)
- (2) Maintenance inspections, adjustments, and repairs
- (3) Technical instructions and technical training
- (4) Product tests or inspections specified by you

The above content assumes transactions and usage within your region. Please consult with an IDEC sales representative regarding transactions and usage outside of your region. Also, IDEC provides no guarantees whatsoever regarding IDEC products sold outside your region.

# IDEC CORPORATION

**Head Office** 6-64, Nishi-Miyahara-2-Chome, Yodogawa-ku, Osaka 532-0004, Japan

 [www.idec.com](http://www.idec.com)

**USA** IDEC Corporation  
**EMEA** APEM SAS

**Singapore** IDEC Izumi Asia Pte. Ltd.  
**Thailand** IDEC Asia (Thailand) Co., Ltd.  
**India** IDEC Controls India Private Ltd.

**China** IDEC (Shanghai) Corporation  
IDEC Izumi (H.K.) Co., Ltd.  
**Taiwan** IDEC Taiwan Corporation

**Japan** IDEC Corporation

Specifications and other descriptions in this brochure are subject to change without notice.

2022 IDEC Corporation, All Rights Reserved.

