

Solid-State Switching Devices for Resistive Loads

General data

Overview

Type	Solid-state relays			Solid-state contactors		Function modules					
	1-phase 22.5 mm	45 mm	3-phase 45 mm	1-phase	3-phase	Converters	Load monitoring		Heating current monitoring	Power controllers	Power regulators
							Basic	Extended			
Usage											
Simple replacement of existing solid-state relays	<input type="checkbox"/>	<input checked="" type="checkbox"/>	<input type="checkbox"/>	<input type="checkbox"/>	<input type="checkbox"/>	--	--	--	--	--	--
Complete unit "Ready to use"	<input type="checkbox"/>	<input type="checkbox"/>	<input type="checkbox"/>	<input checked="" type="checkbox"/>	<input checked="" type="checkbox"/>	--	--	--	--	--	--
Space-saving	<input checked="" type="checkbox"/>	--	<input checked="" type="checkbox"/>	<input checked="" type="checkbox"/>	<input checked="" type="checkbox"/>	<input checked="" type="checkbox"/>	<input checked="" type="checkbox"/>	--	--	--	--
Can be extended with modular function modules	<input checked="" type="checkbox"/>	--	1)	<input checked="" type="checkbox"/>	1)	--	--	--	--	--	--
Frequent switching and monitoring of loads and solid-state relays/solid-state contactors	--	--	--	--	--	--	<input checked="" type="checkbox"/>	<input checked="" type="checkbox"/>	<input checked="" type="checkbox"/>	<input checked="" type="checkbox"/>	<input checked="" type="checkbox"/>
Monitoring of up to 6 partial loads	--	--	--	--	--	--	<input checked="" type="checkbox"/>	--	<input checked="" type="checkbox"/>	<input checked="" type="checkbox"/>	--
Monitoring of more than 6 partial loads	--	--	--	--	--	--	--	<input checked="" type="checkbox"/>	--	--	--
Control of the heating power through an analog input	--	--	--	--	--	<input checked="" type="checkbox"/>	--	--	--	<input checked="" type="checkbox"/>	<input checked="" type="checkbox"/>
Power control	--	--	--	--	--	--	--	--	--	--	<input checked="" type="checkbox"/>
Startup											
Easy setting of setpoint values with "Teach" button	--	--	--	--	--	--	<input checked="" type="checkbox"/>	<input checked="" type="checkbox"/>	--	<input checked="" type="checkbox"/>	<input checked="" type="checkbox"/>
"Remote Teach" input for setting setpoints	--	--	--	--	--	--	--	--	<input checked="" type="checkbox"/>	--	--
Mounting											
Mounting onto mounting rails or mounting plates	--	--	--	<input checked="" type="checkbox"/>	<input checked="" type="checkbox"/>	--	--	--	--	--	--
Can be snapped directly onto a solid-state relay or contactor	--	--	--	--	--	<input checked="" type="checkbox"/>	<input checked="" type="checkbox"/>	<input checked="" type="checkbox"/>	<input checked="" type="checkbox"/>	<input checked="" type="checkbox"/>	<input checked="" type="checkbox"/>
For use with "Cool-plate" heat sink	<input checked="" type="checkbox"/>	<input checked="" type="checkbox"/>	<input checked="" type="checkbox"/>	--	--	--	--	--	--	--	--
Cable routing											
Connection of load circuit as for controlgear	<input checked="" type="checkbox"/>	--	<input checked="" type="checkbox"/>	<input checked="" type="checkbox"/>	<input checked="" type="checkbox"/>	--	<input checked="" type="checkbox"/>	<input checked="" type="checkbox"/>	<input checked="" type="checkbox"/>	<input checked="" type="checkbox"/>	<input checked="" type="checkbox"/>
Connection of load circuit from above	--	<input checked="" type="checkbox"/>	--	--	--	--	--	--	--	--	--

✓ Function is available

☐ Function is possible

-- Function not available

1) The converter can also be used with three-phase devices.

Order No. scheme

Digit of the Order No.	1st - 3rd	4th	5th	6th	7th	8th	9th	10th	11th	12th			
	<input type="checkbox"/> <input type="checkbox"/> <input type="checkbox"/>	<input type="checkbox"/>	<input type="checkbox"/>	<input type="checkbox"/>	<input type="checkbox"/>	-	<input type="checkbox"/>	<input type="checkbox"/>	<input type="checkbox"/>	<input type="checkbox"/>			
Solid-state switching devices	3 R F												
SIRIUS solid-state switching device generation	<input type="checkbox"/>												
Design	<input type="checkbox"/>												
Type current	<input type="checkbox"/>												
Connection type	<input type="checkbox"/>												
Switching function	<input type="checkbox"/>												
Single-phase or number of controlled phases	<input type="checkbox"/>												
Rated control supply voltage	<input type="checkbox"/>												
Rated operational voltage	<input type="checkbox"/>												
Example	3	R	F	2	1	2	0	-	1	A	A	0	4

Note:

The Order No. scheme is presented here merely for information purposes and for better understanding of the logic behind the order numbers.

For your orders, please use the order numbers quote in the catalog in the Selection and ordering data.

Benefits

Characteristics

- Considerable space savings thanks to a width of only 22.5 mm
- Variety of connection methods: Screw terminals, spring-type terminals or ring terminal lugs, there is no problem – they are all finger-safe
- Flexible for all applications with function modules for retrofitting
- Possibility of fuseless short-circuit proof design

Advantages

- Saves time and costs with fast mounting and commissioning, short start-up times and easy wiring
- Extremely long life, low maintenance, rugged and reliable
- Space-saving and safe thanks to side-by-side mounting up to an ambient temperature of +60 °C
- Modular design: Standardized function modules and heat sinks can be used in conjunction with solid-state relays to satisfy individual requirements
- Safety due to lifelong, vibration-resistant and shock-resistant spring-type terminal connection method even under tough conditions

Application

Applications

Example: Plastics processing industry

Thanks to their high switching endurance, SIRIUS solid-state switching devices are ideally suited for use in the control of electrical heat. This is because the more precise the temperature regulation process has to be, the higher the switching frequency. The accurate regulation of electrical heat is used for example in many processes in the plastics processing industry:

- Band heaters heat the extrudate to the correct temperature in plastic extruders
- Heat emitters heat plastic blanks to the correct temperature
- Heat drums dry plastic granules
- Heating channels keep molds at the correct temperature in order to manufacture different plastic parts without defects

The powerful SIRIUS solid-state relays and contactors can be used to control several heating loads at the same time. By using a load monitoring module the individual partial loads can easily be monitored, and in the event of a failure a signal is generated to be sent to the controller.

Use in fuseless load feeders

Short-circuit protection and line protection with miniature circuit breakers is easy to achieve with SIRIUS solid-state relays and solid-state contactors in comparison with designing load feeders with fuses. A special version of the solid-state contactors can be protected against damage in the case of a short circuit with a miniature circuit breaker with type B tripping characteristic. This allows the low-cost and simple design of fuseless load feeders with full protection of the switchgear.

Solid-State Switching Devices for Resistive Loads

General data

Selection and ordering data

Inscription labels for 3RF2 series

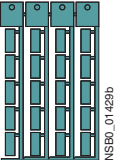
Designation	Labeling area (W x H) mm x mm	Color	DT	Order No.	Price per PU	PU (UNIT, SET, M)	PS*	PG
Blank labels								
 Unit labeling plates (1 frame = 20 units)	Unit labeling plates for "SIRIUS"¹⁾	10 x 7	Pastel turquoise	C	3RT19 00-1SB10	100	816 unit	101
		20 x 7	Pastel turquoise	D	3RT19 00-1SB20	100	340 units	101
	Labels for sticking for SIRIUS	19 x 6	Pastel turquoise	C	3RT19 00-1SB60	100	3060 units	101
		19 x 6	Zinc yellow	C	3RT19 00-1SD60	100	3060 units	101

¹⁾ Computer labeling system for individual inscription of unit labeling plates are available from:
Murrplastik Systemtechnik GmbH
(see Chapter 13, "Appendix" --> "External Partners").

More information

Notes on integration in the load feeders

The SIRIUS solid-state switching devices are very easy to integrate into the load feeders thanks to their industrial connection method and design.

Particular attention must however be paid to the circumstances of the installation and ambient conditions, as the performance of the solid-state switching devices is largely dependent on these. Depending on the version, certain restrictions must be observed. Detailed information, for example in relation to solid-state contactors about the minimum spacing and to solid-state relays about the choice of heat sink, is given in the technical specifications (see manual) and the product data sheets.

For applications with a very large power requirement it is possible to use SIVOLT AC power controller. [More information on the product range can be found in the Catalog DA 68 or in the Industry Mall.](#)

<http://support.automation.siemens.com/WW/view/de/10862346>

See ID: 10752358

Short-circuit and overload protection

Despite the rugged power semiconductors that are used, solid-state switching devices respond more sensitively to short circuits in the load feeder. Consequently, special precautions have to be taken against destruction, depending on the type of design.

Siemens generally recommends using SITOR semiconductor protection fuses. These fuses also provide protection against destruction in the event of a short circuit even when the solid-state contactors and solid-state relays are fully utilized.

Alternatively, if there is lower loading, protection can also be provided by standard fuses or miniature circuit breakers. This protection is achieved by overdimensioning the solid-state switching devices accordingly. The technical specifications and the product data sheets contain details both about the solid-state fuse protection itself and about use of the devices with conventional protection equipment.

Electromagnetic compatibility (EMC)

The solid-state switching devices are suitable for interference-free operation in industrial networks without further measures. If they are used in public networks, it may be necessary for conducted interference to be reduced by means of filters.

This does not include the solid-state contactors for resistive loads of the special type 3RF23 ...-CA.. "Low Noise". These comply with the class B limit values up to a rated current of 16 A. If other versions are used, and at currents of over 16 A, standard filters can be used in order to comply with the limit values. The decisive factors when it comes to selecting the filters are essentially the current loading and the other parameters (operational voltage, design type, etc.) in the load feeder.

Suitable filters can be ordered from EPCOS AG. You can find more information on the Internet at:

www.epcos.com

Overview

Solid-state relays

SIRIUS solid-state relays are suitable for surface mounting on existing cooling surfaces. Mounting is quick and easy, involving just two screws. The special technology of the power semiconductor ensures there is excellent thermal contact with the heat sink. Depending on the nature of the heat sink, the capacity reaches up to 88 A on resistive loads.

The solid-state relays are available in three different versions:

- 3RF21 single-phase solid-state relay with a width of 22.5 mm
- 3RF20 single-phase solid-state relay with a width of 45 mm
- 3RF22 three-phase solid-state relay with a width of 45 mm

The 3RF21 and 3RF22 solid-state relays can be expanded with various function modules to adapt them to individual applications.

Version for resistive loads, "zero-point switching"

This standard version is often used for switching space heaters on and off.

Version for inductive loads, "instantaneous switching"

In this version the solid-state relay is specifically matched to inductive loads. Whether it is a matter of frequent actuation of the valves in a filling plant or starting and stopping small operating mechanisms in packet distribution systems, operation is carried out safely and noiselessly.

Special "Low noise" version

Thanks to a special control circuit, this special version can be used in public networks up to 16 A without any additional measures, such as interference suppressor filters. As a result, in terms of emitted interference, it conforms to limit value curve class B according to EN 60947-4-3.

Single-phase solid-state relays with a width of 22.5 mm

With its compact design and a width of just 22.5 mm, which stays the same even at currents of up to 88 A, the 3RF21 solid-state relay offers an ultra small footprint. The logical connection method, with the power infeed from above and load connection from below, ensures tidy installation in the control cabinet.

Single-phase solid-state relays with a width of 45 mm

The solid-state relays with a width of 45 mm provide for connection of the power supply lead and the load from above. This makes it easy to replace existing solid-state relays in existing arrangements. The connection of the control cable also saves space in much the same way as the 22.5 mm design, as it is simply plugged on.

Three-phase solid-state relays with a width of 45 mm

With its compact design and a width of just 45 mm, which stays the same even at currents of up to 55 A, the 3RF22 solid-state relay offers an ultra small footprint. The logical connection method, with the power infeed from above and load connection from below, ensures tidy installation in the control cabinet.

The three-phase solid-state relays are available with

- two-phase control (suitable in particular for circuits without connection to the neutral conductor) and
- three-phase control (suitable for star circuits with connection to the neutral conductor or for applications in which the system requires all phases to be switched)

Selection notes

When selecting solid-state relays, in addition to information about the network, the load and the ambient conditions it is also necessary to know details of the planned design. The solid-state relays can only conform to their specific technical specifications if they are mounted with appropriate care on an adequately dimensioned heat sink.

The following procedure is recommended:

- Determine the rated current of the load and the mains voltage
- Select the relay design and choose a solid-state relay with higher rated current than the load
- Determine the thermal resistance of the proposed heat sink
- Check the correct relay size with the aid of the diagrams

You can find more information on the Internet at:

www.siemens.com/solid-state-switching-devices

Solid-State Switching Devices for Resistive Loads





Solid-State Relays

SIRIUS 3RF21 solid-state relays, single-phase, 22.5 mm

Overview

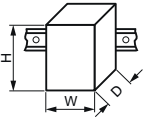
With its compact design and a width of just 22.5 mm, which stays the same even at currents of up to 88 A, the 3RF21 solid-state relay offers an ultra small footprint. The logical connection method, with the power infeed from above and load connection from below, ensures tidy installation in the control cabinet.

Technical specifications

Type		3RF21 ..-1....	3RF21 ..-2....	3RF21 ..-3....
Dimensions (W x H x D)	 mm	22.5 x 85 x 48	22.5 x 85 x 48	22.5 x 85 x 48
General data				
Ambient temperature				
• During operation, derating from 40 °C	°C	-25 ... + 60		
• During storage	°C	-55 ... + 80		
Installation altitude	m	0 ... 1000; derating from 1000		
Shock resistance acc. to IEC 60068-2-27	g/ms	15/11		
Vibration resistance acc. to IEC 60068-2-6	g	2		
Degree of protection		IP20		
Electromagnetic compatibility (EMC)				
• Emitted interference		Class A for industrial applications		
- Conducted interference voltage acc. to IEC 60947-4-3		Class B for residential, business and commercial applications		
- Emitted, high-frequency interference voltage acc. to IEC 60947-4-3				
• Interference immunity		Contact discharge 4; air discharge 8; behavior criterion 2		
- Electrostatic discharge acc. to IEC 61000-4-2 (corresponds to degree of severity 3)	kV			
- Induced RF fields acc. to IEC 61000-4-6	MHz	0.15 ... 80; 140 dBµV; behavior criterion 1		
- Burst acc. to IEC 61000-4-4	kV	2/5.0 kHz; behavior criterion 2		
- Surge acc. to IEC 61000-4-5	kV	Conductor - ground 2; conductor - conductor 1; behavior criterion 2		
Connection type		 Screw terminals	 Spring-type terminals	 Ring terminal lug connections
Connection, main contacts				
• Conductor cross-sections	mm ²	2 x (1.5 ... 2.5) ¹⁾ ; 2 x (2.5 ... 6) ¹⁾	2 x (0.5 ... 2.5)	--
- Solid	mm ²	2 x (1 ... 2.5) ¹⁾ ; 2 x (2.5 ... 6) ¹⁾ ;	2 x (0.5 ... 1.5)	--
- Finely stranded with end sleeve	mm ²	1 x 10	--	--
- Finely stranded without end sleeve	mm ²	--	2 x (0.5 ... 2.5)	--
- Solid or stranded, AWG cables		2 x (AWG 14 ... 10)	2 x (AWG 18 ... 14)	--
• Terminal screw		M4	--	M5
• Tightening torque	Nm	2 ... 2.5	--	2.5 ... 2
	lb.in	7 ... 10.3	--	10.3 ... 7
• Cable lug		--	--	DIN 46234 -5-2.5, -5-6, -5-10,
- DIN		--	--	-5-16, -5-25
- JIS		--	--	JIS C 2805 R 2-5, 5.5-5, 8-5, 14-5
Connection, auxiliary/control contacts				
• Conductor cross-sections	mm	1 x (0.5 ... 2.5), 2 x (0.5 ... 1.0)	0.5 ... 2.5	1 x (0.5 ... 2.5), 2 x (0.5 ... 1.0)
	AWG	20 ... 12	20 ... 12	20 ... 12
• Stripped length	mm	7	10	7
• Terminal screw		M3	--	M3
• Tightening torque	Nm	0.5 ... 0.6	--	0.5 ... 0.6
	lb.in	4.5 ... 5.3	--	4.5 ... 5.3

¹⁾ If two different conductor cross-sections are connected to one clamping point, both cross-sections must lie in the range specified. If identical cross-sections are used, this restriction does not apply.

Solid-State Switching Devices for Resistive Loads

Solid-State Relays

SIRIUS 3RF21 solid-state relays,
single-phase, 22.5 mm

Order No.	$I_{\max}^{1)}$ at $R_{\text{thha}}/T_u = 40\text{ °C}$		I_e acc. to IEC 60947-4-3 at $R_{\text{thha}}/T_u = 40\text{ °C}$		I_e acc. to UL/CSA at $R_{\text{thha}}/T_u = 50\text{ °C}$		Power loss at I_{\max} W	Minimum load current A	Leakage current mA
	A	K/W	A	K/W	A	K/W			
Main circuit									
3RF21 20-.....	20	2.0	20	1.7	20	1.3	28.6	0.1	10
3RF21 30-1....	30	1.1	30	0.79	30	0.56	44.2	0.5	10
3RF21 50-1....	50	0.68	50	0.48	50	0.33	66	0.5	10
3RF21 50-2....	50	0.68	20	2.6	20	2.9	66	0.5	10
3RF21 50-3....	50	0.68	50	0.48	50	0.33	66	0.5	10
3RF21 70-1....	70	0.40	50	0.77	50	0.6	94	0.5	10
3RF21 90-1....	88	0.33	50	0.94	50	0.85	118	0.5	10
3RF21 90-2....	88	0.33	20	2.8	20	3.5	118	0.5	10
3RF21 90-3....	88	0.33	88	0.22	83	0.19	118	0.5	10

¹⁾ I_{\max} provides information about the performance of the solid-state relay.
The actual permitted rated operational current I_e can be smaller depending on the connection method and cooling conditions.

Note:

The required heat sinks for the corresponding load currents can be determined from the characteristic curves (see note on Technical Information, page 4/1). The minimum thickness values for the mounting surface must be observed.

Order No.	Rated impulse withstand capacity I_{tsm}		I^2t value A ² s
	A		
Main circuit			
3RF21 20-.....	200		200
3RF21 30-..A.2	300		450
3RF21 30-..A.4	300		450
3RF21 30-..A.5	300		450
3RF21 30-..A.6	400		800
3RF21 50-.....	600		1800
3RF21 70-..A.2	1200		7200
3RF21 70-..A.4	1200		7200
3RF21 70-..A.5	1200		7200
3RF21 70-..A.6	1150		6600
3RF21 90-.....	1150		6600

Type		3RF21 ..-...2	3RF21 ..-...4	3RF21 ..-...5	3RF21 ..-...6
Main circuit					
Rated operational voltage U_e	V AC	24 ... 230	48 ... 460	48 ... 600	48 ... 600
• Operating range	V AC	20 ... 253	40 ... 506	40 ... 660	40 ... 660
• Rated frequency	Hz	50/60 ± 10 %			
Rated insulation voltage U_i	V	600			
Blocking voltage	V	800	1200		1600
Rage of voltage rise	V/μs	1000			

Type		3RF21 ..-...0.	3RF21 ..-...1.	3RF21 ..-...2.	3RF21 ..-...4.
Control circuit					
Method of operation		DC operation	AC/DC operation	AC operation	DC operation
Rated control supply voltage U_s	V	24 acc. to EN 61131-2	24 AC	24 DC	110 ... 230
Rated frequency of the control supply voltage	Hz	--	50/60 ± 10 %	--	50/60 ± 10 %
Control supply voltage, max.	V	30	26.5 AC	30 DC	253
Typical actuating current	mA	20/Low Power: 6.5 ¹⁾	20	20	15
Response voltage	V	15	14 AC	15 DC	90
Drop-out voltage	V	5	5 AC	5 DC	40
Operating times					
• ON-delay	ms	1 + max. one half-wave ²⁾	10 + max. one half-wave ²⁾	40 + max. one half-wave ²⁾	1 + max. one half-wave ²⁾
• OFF-delay	ms	1 + max. one half-wave	15 + max. one half-wave	40 + max. one half-wave	1 + max. one half-wave

¹⁾ Applies to the version "Low Power" 3RF21 ..-AA..-0KN0.

²⁾ Only for zero-point-switching devices.

Solid-State Switching Devices for Resistive Loads

Solid-State Relays

SIRIUS 3RF21 solid-state relays, single-phase, 22.5 mm

Circuit diagrams

DC control supply voltage

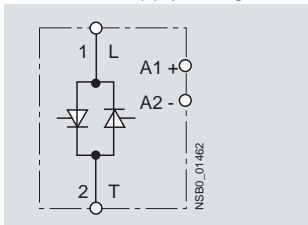

AC control supply voltage

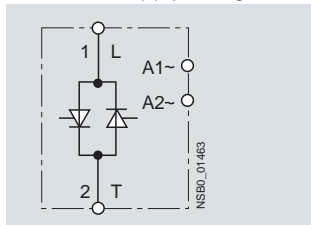

Selection and ordering data

Type current ¹⁾	Rated control supply voltage U_s	DT	Screw terminals ²⁾	⊕ PU (UNIT, SET, M)	PS*	PG	
A	V		Order No.	Price per PU			
Zero-point switching							
Rated operational voltage U_e 24 ... 230 V AC							
	20	24 DC acc. to EN 61131-2	A	3RF21 20-1AA02	1	1 unit	101
	30		A	3RF21 30-1AA02	1	1 unit	101
	50		A	3RF21 50-1AA02	1	1 unit	101
	70		A	3RF21 70-1AA02	1	1 unit	101
	90		A	3RF21 90-1AA02	1	1 unit	101
	20	110 ... 230 AC	A	3RF21 20-1AA22	1	1 unit	101
	30		A	3RF21 30-1AA22	1	1 unit	101
	50		A	3RF21 50-1AA22	1	1 unit	101
	70		A	3RF21 70-1AA22	1	1 unit	101
	90		A	3RF21 90-1AA22	1	1 unit	101
	20	4 ... 30 DC	B	3RF21 20-1AA42	1	1 unit	101
	30		B	3RF21 30-1AA42	1	1 unit	101
	Zero-point switching						
	Rated operational voltage U_e 48 ... 460 V AC						
20	24 DC acc. to EN 61131-2	A	3RF21 20-1AA04	1	1 unit	101	
30		A	3RF21 30-1AA04	1	1 unit	101	
50		A	3RF21 50-1AA04	1	1 unit	101	
70		A	3RF21 70-1AA04	1	1 unit	101	
90		A	3RF21 90-1AA04	1	1 unit	101	
20	24 AC/DC	A	3RF21 50-1AA14	1	1 unit	101	
20	110 ... 230 AC	A	3RF21 20-1AA24	1	1 unit	101	
30		A	3RF21 30-1AA24	1	1 unit	101	
50		A	3RF21 50-1AA24	1	1 unit	101	
70		A	3RF21 70-1AA24	1	1 unit	101	
90		A	3RF21 90-1AA24	1	1 unit	101	
Zero-point switching							
Rated operational voltage U_e 48 ... 600 V AC							
70	24 DC Low Power	B	3RF21 70-1AA05-0KN0	1	1 unit	101	
20	4 ... 30 DC	B	3RF21 20-1AA45	1	1 unit	101	
30		B	3RF21 30-1AA45	1	1 unit	101	
50		B	3RF21 50-1AA45	1	1 unit	101	
70		B	3RF21 70-1AA45	1	1 unit	101	
90		B	3RF21 90-1AA45	1	1 unit	101	
Zero-point switching · Blocking voltage 1600 V							
Rated operational voltage U_e 48 ... 600 V AC							
30	24 DC acc. to EN 61131-2	A	3RF21 30-1AA06	1	1 unit	101	
50		A	3RF21 50-1AA06	1	1 unit	101	
70		B	3RF21 70-1AA06	1	1 unit	101	
90		B	3RF21 90-1AA06	1	1 unit	101	
30	110 ... 230 AC	B	3RF21 30-1AA26	1	1 unit	101	
50		B	3RF21 50-1AA26	1	1 unit	101	
70		B	3RF21 70-1AA26	1	1 unit	101	
90		B	3RF21 90-1AA26	1	1 unit	101	

Other rated control supply voltages on request.

- The type current provides information about the performance capacity of the solid-state relay. The actual permitted rated operational current I_e can be smaller depending on the connection method and cooling conditions.
- Please note that this version can only be used for a rated current of up to approx. 50 A and a conductor cross-section of 10 mm².

Solid-State Switching Devices for Resistive Loads

Solid-State Relays

SIRIUS 3RF21 solid-state relays,
single-phase, 22.5 mm

Type current ¹⁾	Rated control supply voltage U_s	DT	Screw terminals ²⁾	PU (UNIT, SET, M)	PS*	PG
A	V		Order No.	Price per PU		
Instantaneous switching Rated operational voltage U_e 24 ... 230 V AC						
50	110 ... 230 AC	A	3RF21 50-1BA22	1	1 unit	101
Instantaneous switching Rated operational voltage U_e 48 ... 460 V AC						
20	24 DC acc. to EN 61131-2	B	3RF21 20-1BA04	1	1 unit	101
30		B	3RF21 30-1BA04	1	1 unit	101
50		B	3RF21 50-1BA04	1	1 unit	101
70		A	3RF21 70-1BA04	1	1 unit	101
90		B	3RF21 90-1BA04	1	1 unit	101
Instantaneous switching · Blocking voltage 1600 V Rated operational voltage U_e 48 ... 600 V AC						
50	24 DC acc. to EN 61131-2	B	3RF21 50-1BA06	1	1 unit	101
Low noise³⁾ · Zero-point switching Rated operational voltage U_e 48 ... 460 V AC						
70	24 DC acc. to EN 61131-2	B	3RF21 70-1CA04	1	1 unit	101

Other rated control supply voltages on request.

1) The type current provides information about the performance capacity of the solid-state relay. The actual permitted rated operational current I_e can be smaller depending on the connection method and cooling conditions.

2) Please note that this version can only be used for a rated current of up to approx. 50 A and a conductor cross-section of 10 mm².

3) See page 4/65.

Type current ¹⁾	Rated control supply voltage U_s	DT	Spring-type terminals ²⁾	PU (UNIT, SET, M)	PS*	PG
A	V		Order No.	Price per PU		
Zero-point switching Rated operational voltage U_e 24 ... 230 V AC						
20	24 DC acc. to EN 61131-2	A	3RF21 20-2AA02	1	1 unit	101
50		B	3RF21 50-2AA02	1	1 unit	101
90		B	3RF21 90-2AA02	1	1 unit	101
20	110 ... 230 AC	B	3RF21 20-2AA22	1	1 unit	101
50		B	3RF21 50-2AA22	1	1 unit	101
90		B	3RF21 90-2AA22	1	1 unit	101
20	4 ... 30 DC	B	3RF21 20-2AA42	1	1 unit	101
Zero-point switching Rated operational voltage U_e 48 ... 460 V AC						
20	24 DC acc. to EN 61131-2	B	3RF21 20-2AA04	1	1 unit	101
50		B	3RF21 50-2AA04	1	1 unit	101
90		B	3RF21 90-2AA04	1	1 unit	101
50	24 AC/DC	B	3RF21 50-2AA14	1	1 unit	101
20	110 ... 230 AC	B	3RF21 20-2AA24	1	1 unit	101
50		B	3RF21 50-2AA24	1	1 unit	101
90		B	3RF21 90-2AA24	1	1 unit	101
Zero-point switching Rated operational voltage U_e 48 ... 600 V AC						
20	4 ... 30 DC	B	3RF21 20-2AA45	1	1 unit	101
Zero-point switching · Blocking voltage 1600 V Rated operational voltage U_e 48 ... 600 V AC						
50	24 DC acc. to EN 61131-2	B	3RF21 50-2AA06	1	1 unit	101
90		B	3RF21 90-2AA06	1	1 unit	101
50	110 ... 230 AC	B	3RF21 50-2AA26	1	1 unit	101
90		B	3RF21 90-2AA26	1	1 unit	101



3RF21 20-2AA02

Other rated control supply voltages on request.

1) The type current provides information about the performance capacity of the solid-state relay. The actual permitted rated operational current I_e can be smaller depending on the connection method and cooling conditions.

2) Please note that the version with spring-type terminals can only be used for a rated current of up to approx. 20 A and a conductor cross-section of 2.5 mm². Higher currents are possible by connecting two conductors per terminal.

* You can order this quantity or a multiple thereof.
Illustrations are approximate

Solid-State Switching Devices for Resistive Loads





Solid-State Relays

**SIRIUS 3RF21 solid-state relays,
single-phase, 22.5 mm**

Type current ¹⁾	Rated control supply voltage U_s	DT	Ring terminal lug connection	PU (UNIT, SET, M)	PS*	PG	
A	V		Order No.	Price per PU			
Zero-point switching Rated operational voltage U_e 24 ... 230 V AC							
	20	24 DC acc. to EN 61131-2	A	3RF21 20-3AA02	1	1 unit	101
	50		B	3RF21 50-3AA02	1	1 unit	101
	90		B	3RF21 90-3AA02	1	1 unit	101
	20	110 ... 230 AC	B	3RF21 20-3AA22	1	1 unit	101
	50		B	3RF21 50-3AA22	1	1 unit	101
	90		B	3RF21 90-3AA22	1	1 unit	101
Zero-point switching Rated operational voltage U_e 48 ... 460 V AC							
	20	24 DC acc. to EN 61131-2	B	3RF21 20-3AA04	1	1 unit	101
	50		B	3RF21 50-3AA04	1	1 unit	101
	90		B	3RF21 90-3AA04	1	1 unit	101
	20	110 ... 230 AC	B	3RF21 20-3AA24	1	1 unit	101
	50		B	3RF21 50-3AA24	1	1 unit	101
	90		B	3RF21 90-3AA24	1	1 unit	101
	90	4 ... 30 DC	B	3RF21 90-3AA44	1	1 unit	101
	Zero-point switching · Blocking voltage 1600 V Rated operational voltage U_e 48 ... 600 V AC						
	50	24 DC acc. to EN 61131-2	B	3RF21 50-3AA06	1	1 unit	101
	90		B	3RF21 90-3AA06	1	1 unit	101
	50	110 ... 230 AC	B	3RF21 50-3AA26	1	1 unit	101
	90		B	3RF21 90-3AA26	1	1 unit	101

Other rated control supply voltages on request.

¹⁾ The type current provides information about the performance capacity of the solid-state relay. The actual permitted rated operational current I_e can be smaller depending on the connection method and cooling conditions.

Version	DT	Order No.	Price per PU	PU (UNIT, SET, M)	PS*	PG
Optional accessories						
	A	Spring-type terminals		1	1 unit	101
		3RA29 08-1A				
3RA29 08-1A						
	A	Ring terminal lug connection		1	10 units	101
		3RF29 00-3PA88				
3RF29 00-3PA88						

Solid-State Switching Devices for Resistive Loads



Solid-State Relays

**SIRIUS 3RF20 solid-state relays,
single-phase, 45 mm**

Overview

The solid-state relays with a width of 45 mm provide for connection of the power supply lead and the load from above. This makes it easy to replace existing solid-state relays in existing arrangements. The connection of the control cable also saves space in much the same way as the 22.5 mm design, as it is simply plugged on.

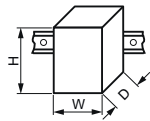
Technical specifications

Type		3RF20 ..-1....	3RF20 ..-4....
Dimensions (W x H x D)	 mm	45 x 58 x 48	45 x 58 x 48
General data			
Ambient temperature			
• During operation, derating from 40 °C	°C	-25 ... +60	
• During storage	°C	-55 ... +80	
Installation altitude	m	0 ... 1000; derating from 1000	
Shock resistance acc. to IEC 60068-2-27	g/ms	15 / 11	
Vibration resistance acc. to IEC 60068-2-6	g	2	
Degree of protection		IP20	
Electromagnetic compatibility (EMC)			
• Emitted interference			
- Conducted interference voltage acc. to IEC 60947-4-3		Class A for industrial applications	
- Emitted, high-frequency interference voltage acc. to IEC 60947-4-3		Class B for residential, business and commercial applications	
• Interference immunity			
- Electrostatic discharge acc. to IEC 61000-4-2 (corresponds to degree of severity 3)	kV	Contact discharge 4; air discharge 8; behavior criterion 2	
- Induced RF fields acc. to IEC 61000-4-6	MHz	0.15 ... 80; 140 dBµV; behavior criterion 1	
- Burst acc. to IEC 61000-4-4	kV	2/5.0 kHz; behavior criterion 2	
- Surge acc. to IEC 61000-4-5	kV	Conductor - ground 2; conductor - conductor 1; behavior criterion 2	
Connection type		 Screw terminals	 Spring-type terminals
Connection, main contacts			
• Conductor cross-sections	mm ²		
- Solid	mm ²	2 x (1.5 ... 2.5) ¹⁾ ; 2 x (2.5 ... 6) ¹⁾	
- Finely stranded with end sleeve	mm ²	2 x (1 ... 2.5) ¹⁾ ; 2 x (2.5 ... 6) ¹⁾ ; 1 x 10	
- Solid or stranded, AWG cables		2x (AWG 14 ... 10)	
• Terminal screw		M4	
• Tightening torque	Nm lb.in	2 ... 2.5 7 ... 10.3	
Connection, auxiliary/control contacts			
• Conductor cross-sections	mm ²	1 x (0.5 ... 2.5), 2 x (0.5 ... 1.0), AWG 20 ... 12	
• Stripped length	mm	7	
• Terminal screw		M3	
• Tightening torque	Nm lb.in	0.5 ... 0.6 4.5 ... 5.3	

¹⁾ If two different conductor cross-sections are connected to one clamping point, both cross-sections must lie in the range specified. If identical cross-sections are used, this restriction does not apply.

Solid-State Switching Devices for Resistive Loads

Solid-State Relays

SIRIUS 3RF20 solid-state relays, single-phase, 45 mm

Order No.	$I_{\max}^{1)}$ at $R_{\text{thha}}/T_u = 40\text{ °C}$		I_e acc. to IEC 60947-4-3 at $R_{\text{thha}}/T_u = 40\text{ °C}$		I_e acc. to UL/CSA at $R_{\text{thha}}/T_u = 50\text{ °C}$		Power loss at I_{\max}	Minimum load current	Leakage current
	A	K/W	A	K/W	A	K/W			
Main circuit									
3RF20 20-1.A..	20	2.0	20	1.7	20	1.3	28.6	0.1	10
3RF20 30-1.A..	30	1.1	30	0.79	30	0.56	44.2	0.5	10
3RF20 50-1.A..	50	0.68	50	0.48	50	0.33	66	0.5	10
3RF20 70-1.A..	70	0.40	50	0.77	50	0.6	94	0.5	10
3RF20 90-1.A..	88	0.33	50	0.94	50	0.85	118	0.5	10

¹⁾ I_{\max} provides information about the performance of the solid-state relay. The actual permitted rated operational current I_e can be smaller depending on the connection method and cooling conditions.

Note:

The required heat sinks for the corresponding load currents can be determined from the characteristic curves (see note on Technical Information, page 4/1). The minimum thickness values for the mounting surface must be observed.

Order No.	Rated impulse withstand capacity I_{tsm}	I^2t value
Main circuit		
3RF20 20-1.A..	200	200
3RF20 30-1.A.2	300	450
3RF20 30-1.A.4	300	450
3RF20 30-1.A.6	400	800
3RF20 50-1.A..	600	1800
3RF20 70-1.A.2	1200	7200
3RF20 70-1.A.4	1200	7200
3RF20 70-1.A.5	1200	7200
3RF20 70-1.A.6	1150	6600
3RF20 90-1.A..	1150	6600

Type		3RF20 .0-1.A.2	3RF20 .0-1.A.4	3RF20 .0-1.A.5	3RF20 .0-1.A.6
Main circuit					
Rated operational voltage U_e	V AC	24 ... 230	48 ... 460	48 ... 600	48 ... 600
• Operating range	V AC	20 ... 253	40 ... 506	40 ... 660	40 ... 660
• Rated frequency	Hz	50/60 ± 10 %			
Rated insulation voltage U_i	V	600			
Blocking voltage	V	800	1200	1600	
Rate of voltage rise	V/μs	1000			

Type		3RF20 .0-1.A.0.	3RF20 .0-1.A.2.	3RF20 .0-1.A.4.
Control circuit				
Method of operation		DC operation	AC operation	DC operation
Rated control supply voltage U_S	V	24 acc. to EN 61131-2	110 ... 230	4 ... 30
Rated frequency of the control supply voltage	Hz	--	50/60 ± 10 %	--
Control supply voltage, max.	V	30	253	30
Typical actuating current	mA	20	15	20
Response voltage	V	15	90	4
Drop-out voltage	V	5	40	1
Operating times				
• ON-delay	ms	1 + max. one half-wave ¹⁾	40 + max. one half-wave ¹⁾	1 + max. one half-wave ¹⁾
• OFF-delay	ms	1 + max. one half-wave	40 + max. one half-wave	1 + max. one half-wave

¹⁾ Only for zero-point-switching devices.

Circuit diagrams

DC control supply voltage

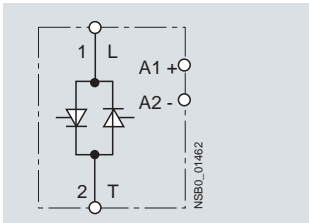

AC control supply voltage

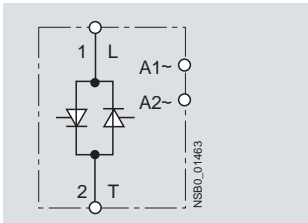

Solid-State Switching Devices for Resistive Loads

Solid-State Relays

SIRIUS 3RF20 solid-state relays,
single-phase, 45 mm

Selection and ordering data

Type current ¹⁾	Rated control supply voltage U_s DT	Screw terminals ²⁾	PU (UNIT, SET, M)	PS*	PG
A	V	Order No.	Price per PU		
Zero-point switching Rated operational voltage U_e 24 ... 230 V AC					
	20	24 DC acc. to EN 61131-2	A	3RF20 20-1AA02	1 1 unit 101
	30		A	3RF20 30-1AA02	1 1 unit 101
	50		A	3RF20 50-1AA02	1 1 unit 101
	70		A	3RF20 70-1AA02	1 1 unit 101
	90		A	3RF20 90-1AA02	1 1 unit 101
	20	110 ... 230 AC	A	3RF20 20-1AA22	1 1 unit 101
	30		A	3RF20 30-1AA22	1 1 unit 101
	50		A	3RF20 50-1AA22	1 1 unit 101
	70		A	3RF20 70-1AA22	1 1 unit 101
	90		A	3RF20 90-1AA22	1 1 unit 101
3RF20 20-1AA02	20	4 ... 30 DC	B	3RF20 20-1AA42	1 1 unit 101
	30		B	3RF20 30-1AA42	1 1 unit 101
Zero-point switching Rated operational voltage U_e 48 ... 460 V AC					
	20	24 DC acc. to EN 61131-2	A	3RF20 20-1AA04	1 1 unit 101
	30		A	3RF20 30-1AA04	1 1 unit 101
	50		A	3RF20 50-1AA04	1 1 unit 101
	70		A	3RF20 70-1AA04	1 1 unit 101
	90		A	3RF20 90-1AA04	1 1 unit 101
	20	110 ... 230 AC	A	3RF20 20-1AA24	1 1 unit 101
	30		A	3RF20 30-1AA24	1 1 unit 101
	50		A	3RF20 50-1AA24	1 1 unit 101
	70		A	3RF20 70-1AA24	1 1 unit 101
	90		A	3RF20 90-1AA24	1 1 unit 101
	50	4 ... 30 DC	A	3RF20 50-1AA44	1 1 unit 101
Zero-point switching Rated operational voltage U_e 48 ... 600 V AC					
	20	4 ... 30 DC	B	3RF20 20-1AA45	1 1 unit 101
	50		B	3RF20 50-1AA45	1 1 unit 101
	70		B	3RF20 70-1AA45	1 1 unit 101
	90		B	3RF20 90-1AA45	1 1 unit 101
Zero-point switching · Blocking voltage 1600 V Rated operational voltage U_e 48 ... 600 V AC					
	30	24 DC acc. to EN 61131-2	B	3RF20 30-1AA06	1 1 unit 101
	50		B	3RF20 50-1AA06	1 1 unit 101
	70		B	3RF20 70-1AA06	1 1 unit 101
	90		B	3RF20 90-1AA06	1 1 unit 101
	30	110 ... 230 AC	B	3RF20 30-1AA26	1 1 unit 101
	50		B	3RF20 50-1AA26	1 1 unit 101
	70		B	3RF20 70-1AA26	1 1 unit 101
	90		B	3RF20 90-1AA26	1 1 unit 101
Instantaneous switching Rated operational voltage U_e 48 ... 460 V AC					
	30	24 DC acc. to EN 61131-2	B	3RF20 30-1BA04	1 1 unit 101

Type current ¹⁾	Rated control supply voltage U_s DT	Screw terminals + spring-type terminals (control current side)	PU (UNIT, SET, M)	PS*	PG
A	V	Order No.	Price per PU		

Zero-point switching

Rated operational voltage U_e 24 ... 230 V AC

	50	24 DC acc. to EN 61131-2	B	3RF20 50-4AA02	1 1 unit 101
---	----	--------------------------	---	-----------------------	--------------

3RF20 50-4AA02

¹⁾ The type current provides information about the performance capacity of the solid-state relay. The actual permitted rated operational current I_e can be smaller depending on the connection method and cooling conditions.

²⁾ Please note that this version can only be used for a rated current of up to approx. 50 A and a conductor cross-section of 10 mm².

Solid-State Switching Devices for Resistive Loads

Solid-State Relays

SIRIUS 3RF22 solid-state relays, three-phase, 45 mm





Overview

With its compact design and a width of just 45 mm, which stays the same even at currents of up to 55 A, the 3RF22 solid-state relay offers an ultra small footprint. The logical connection method, with the power infeed from above and load connection from below, ensures tidy installation in the control cabinet.

Important features:

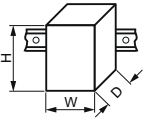
- LED display
- Variety of connection methods
- Plug-in control connection
- Degree of protection IP20
- Zero-point switching
- Two- or three-phase controlled

Technical specifications

Type		3RF22 ..-1....	3RF22 ..-2....	3RF22 ..-3....
Dimensions (W x H x D)		mm 45 x 95 x 47	45 x 95 x 47	45 x 95 x 47
General data				
Ambient temperature				
• During operation, derating from 40 °C	°C	-25 ... + 60		
• During storage	°C	-55 ... + 80		
Installation altitude	m	0 ... 1000; > 1000 ask Technical Assistance		
Shock resistance acc. to IEC 60068-2-27	g/ms	15/11		
Vibration resistance acc. to IEC 60068-2-6	g	2		
Degree of protection		IP20		
Insulation strength at 50/60 Hz (main/control circuit to floor)	V rms	4000		
Electromagnetic compatibility (EMC)				
• Emitted interference		Class A for industrial applications ¹⁾		
- Conducted interference voltage acc. to IEC 60947-4-3				
• Interference immunity		Contact discharge 4; air discharge 8; behavior criterion 2		
- Electrostatic discharge acc. to IEC 61000-4-2 (corresponds to degree of severity 3)	kV			
- Induced RF fields acc. to IEC 61000-4-6	MHz	0.15 ... 80; 140 dBµV; behavior criterion 1		
- Burst acc. to IEC 61000-4-4	kV	2/5.0 kHz; behavior criterion 2		
- Surge acc. to IEC 61000-4-5	kV	Conductor - ground 2; conductor - conductor 1; behavior criterion 2		
Connection type		 Screw terminals	 Spring-type terminals	 Ring terminal lug connection
Connection, main contacts				
• Conductor cross-sections				
- Solid	mm ²	2 x (1.5 ... 2.5) ²⁾ ; 2 x (2.5 ... 6) ²⁾	2 x (0.5 ... 2.5)	--
- Finely stranded with end sleeve	mm ²	2 x (1 ... 2.5) ²⁾ ; 2 x (2.5 ... 6) ²⁾ ; 1 x 10	2 x (0.5 ... 1.5)	--
- Finely stranded without end sleeve	mm ²	--	2 x (0.5 ... 2.5)	--
- Solid or stranded, AWG cables		2 x (AWG 14 ... 10)	2 x (AWG 18 ... 14)	--
• Stripped length	mm	10	10	--
• Terminal screw		M4	--	M5
- Tightening torque,	Nm	2 ... 2.5	--	2.5 ... 2
∅ 5 ... 6 mm, PZ 2	lb.in	18 ... 22	--	18 ... 22
• Cable lug		--	--	--
- According to DIN 46234				5-2.5 ... 5-25
- According to JIS C 2805				R 2-5 ... 14-5
Connection, auxiliary/control contacts				
• Conductor cross-sections, with or without end sleeve	mm AWG	1 x (0.5 ... 2.5), 2 x (0.5 ... 1.0) 20 ... 12	0.5 ... 2.5 20 ... 12	1 x (0.5 ... 2.5), 2 x (0.5 ... 1.0) 20 ... 12
• Stripped length	mm	7	10	7
• Terminal screw		M3	--	M3
- Tightening torque,	Nm	0.5 ... 0.6	--	0.5 ... 0.6
∅ 3.5, PZ 1	lb.in	4.5 ... 5.3	--	4.5 ... 5.3

¹⁾ These products were built as Class A devices. The use of these devices in residential areas could result in lead in radio interference. In this case these may be required to introduce additional interference suppression measures.

²⁾ If two different conductor cross-sections are connected to one clamping point, both cross-sections must lie in the range specified. If identical cross-sections are used, this restriction does not apply.

Solid-State Switching Devices for Resistive Loads

Solid-State Relays

SIRIUS 3RF22 solid-state relays,
three-phase, 45 mm

Order No.	$I_{max}^{1)}$ at $R_{thha}/T_u = 40\text{ °C}$		I_e acc. to IEC 60947-4-3 at $R_{thha}/T_u = 40\text{ °C}$		I_e acc. to UL/CSA at $R_{thha}/T_u = 50\text{ °C}$		Power loss at I_{max} W	Minimum load current A	Max. leakage current mA
	A	K/W	A	K/W	A	K/W			
Main circuit									
3RF22 30-. AB..	30	0.57	30	0.57	30	0.44	81	0.5	10
3RF22 55-1AB..	55	0.18	50	0.27	50	0.19	151	0.5	10
3RF22 55-2AB..			20	1.83	20	1.58			
3RF22 55-3AB..			50	0.27	50	0.19			
3RF22 30-. AC..	30	0.33	30	0.33	30	0.25	122	0.5	10
3RF22 55-1AC..	55	0.09	50	0.15	50	0.1	226	0.5	10
3RF22 55-2AC..			20	1.19	20	1.02			
3RF22 55-3AC..			50	0.15	50	0.1			

¹⁾ I_{max} provides information about the performance of the solid-state relay.
The actual permitted rated operational current I_e can be smaller depending on the connection method and cooling conditions.

Note:

The required heat sinks for the corresponding load currents can be determined from the characteristic curves (see note on Technical Information, page 4/1). The minimum thickness values for the mounting surface must be observed.

Order No.	Rated impulse withstand capacity I_{tsm} A	I^2t value A ² s
3RF22 30-...5	300	450
3RF22 55-...5	600	1800

Type		3RF22 ...-AB.5	3RF22 ...-AC.5
Main circuit			
Controlled phases		2-phase	3-phase
Rated operational voltage U_e	V AC	48 ... 600	48 ... 600
• Operating range	V AC	40 ... 660	40 ... 660
• Rated frequency	Hz	50/60 ± 10 %	50/60 ± 10 %
Rated insulation voltage U_i	V	600	600
Rated impulse withstand voltage U_{imp}	kV	6	6
Blocking voltage	V	1200	1200
Rate of voltage rise	V/μs	1000	1000

Type		3RF22 ...-A.3.	3RF22 ...-A.4.
Control circuit			
Method of operation		AC operation	DC operation
Rated control supply voltage U_s	V	110	4 ... 30
Rated frequency of the control supply voltage		50/60 ± 10 %	--
Control supply voltage, max.	V	121	30
Typical actuating current	mA	15	30
Response voltage	V	90	4
Drop-out voltage	V	< 40	1
Operating times			
• ON-delay	ms	40 + max. one half-wave	1 + max. one half-wave
• OFF-delay	ms	40 + max. one half-wave	1 + max. one half-wave

Circuit diagrams

Two-phase controlled,
DC control supply voltage

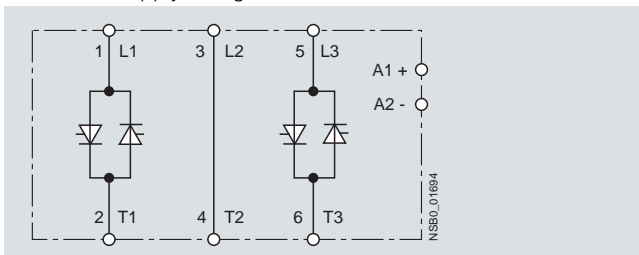

Three-phase controlled,
DC control supply voltage

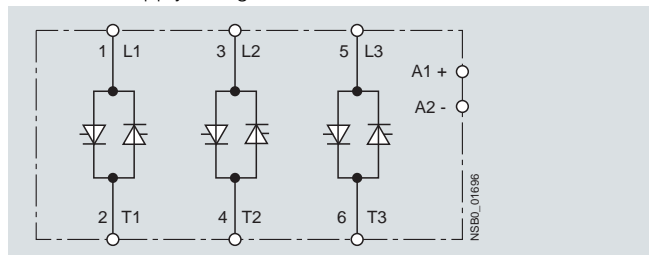

Solid-State Switching Devices for Resistive Loads

Solid-State Relays

**SIRIUS 3RF22 solid-state relays,
three-phase, 45 mm**

Selection and ordering data

Type current ¹⁾	Rated control supply voltage U_s	DT	Screw terminals²⁾	⊕	PU (UNIT, SET, M)	PS*	PG
A	V		Order No.		Price per PU		
Zero-point switching Rated operational voltage U_e 48 ... 600 V AC							
<i>Two-phase controlled</i>							
30	110 AC	B	3RF22 30-1AB35		1	1 unit	101
55		B	3RF22 55-1AB35		1	1 unit	101
30	4 ... 30 DC	B	3RF22 30-1AB45		1	1 unit	101
55		B	3RF22 55-1AB45		1	1 unit	101
<i>Three-phase controlled</i>							
30	110 AC	B	3RF22 30-1AC35		1	1 unit	101
55		B	3RF22 55-1AC35		1	1 unit	101
30	4 ... 30 DC	A	3RF22 30-1AC45		1	1 unit	101
55		B	3RF22 55-1AC45		1	1 unit	101
3RF22 30-1AB45							
Spring-type terminals³⁾							
Type current ¹⁾	Rated control supply voltage U_s	DT	Spring-type terminals³⁾ <th>⊕</th> <th>PU (UNIT, SET, M)</th> <th>PS*</th> <th>PG</th>	⊕	PU (UNIT, SET, M)	PS*	PG
A	V		Order No.		Price per PU		
Zero-point switching Rated operational voltage U_e 48 ... 600 V AC							
<i>Two-phase controlled</i>							
30	4 ... 30 DC	B	3RF22 30-2AB45		1	1 unit	101
55		B	3RF22 55-2AB45		1	1 unit	101
<i>Three-phase controlled</i>							
30	4 ... 30 DC	B	3RF22 30-2AC45		1	1 unit	101
55		B	3RF22 55-2AC45		1	1 unit	101
3RF22 30-2AB45							
Ring terminal lug connection							
Type current ¹⁾	Rated control supply voltage U_s	DT	Ring terminal lug connection <th>⊕</th> <th>PU (UNIT, SET, M)</th> <th>PS*</th> <th>PG</th>	⊕	PU (UNIT, SET, M)	PS*	PG
A	V		Order No.		Price per PU		
Zero-point switching Rated operational voltage U_e 48 ... 600 V AC							
<i>Two-phase controlled</i>							
30	4 ... 30 DC	B	3RF22 30-3AB45		1	1 unit	101
55		B	3RF22 55-3AB45		1	1 unit	101
<i>Three-phase controlled</i>							
30	4 ... 30 DC	B	3RF22 30-3AC45		1	1 unit	101
55		B	3RF22 55-3AC45		1	1 unit	101
3RF22 30-3AB45							

1) The type current provides information about the performance capacity of the solid-state relay.
The actual permitted rated operational current I_e can be smaller depending on the connection method and cooling conditions.

2) Please note that the version with an M4 screw connection can only be used for a rated current of up to approx. 50 A and a conductor cross-section of 10 mm².

3) Please note that the version with spring-type terminals can only be used for a rated current of up to approx. 20 A and a conductor cross-section of 2.5 mm². Higher currents are possible by connecting two conductors per terminal.

Solid-State Switching Devices for Resistive Loads

Solid-State Contactors

General data

Overview

Solid-state contactors

The complete units consist of a solid-state relay plus optimized heat sink, and are therefore ready to use. They offer defined rated currents to make selection as easy as possible. Depending on the version, current intensities of up to 88 A are achieved. Like all of our solid-state switching devices, one of their particular advantages is their compact and space-saving design.

With their insulated mounting foot they can easily be snapped onto a standard mounting rail, or they can be mounted on support plates with fixing screws. This insulation enables them to be used in circuits with protective extra-low voltage (PELV) or safety extra-low voltage (SELV) in building management. For other applications, such as for extended personal safety, the heat sink can be grounded through a screw terminal.

The solid-state contactors are available in 2 different versions:

- 3RF23 single-phase solid-state contactors
- 3RF24 three-phase solid-state contactors

Single-phase versions

The 3RF23 solid-state contactors can be expanded with various function modules to adapt them to individual applications.

Version for resistive loads, "zero-point switching"

This standard version is often used for switching space heaters on and off.

Version for inductive loads, "instantaneous switching"

In this version the solid-state contactor is specifically matched to inductive loads. Whether it is a matter of frequent actuation of the valves in a filling plant or starting and stopping small operating mechanisms in packet distribution systems, operation is carried out safely and noiselessly.

Special "Low noise" version

Thanks to a special control circuit, this special version can be used in public networks up to 16 A without any additional measures, such as interference suppressor filters. As a result, in terms of emitted interference, it conforms to limit value curve class B according to EN 60947-4-3.

Special "Short-circuit proof" version

Skillful matching of the power semiconductor with the performance capacity of the solid-state contactor means that "short-circuit strength" can be achieved with a standard miniature circuit breaker. In combination with a B-type MCB or a conventional line protection fuse, the result is a short-circuit proof feeder.

In order to achieve problem-free short-circuit protection by means of miniature circuit breakers, however, certain boundary conditions must be observed. As the magnitude and duration of the short-circuit current are determined not only by the short-circuit breaking response of the miniature circuit breaker but also the properties of the wiring system, such as the internal resistance of the input to the network and damping by controls and cables, particular attention must also be paid to these parameters. The necessary cable lengths are therefore shown for the main factor, the line resistance, in the table below.

The following miniature circuit breakers with a B characteristic and 10 kA or 6 kA breaking capacity protect the 3RF23...DA.. solid-state contactors in the event of short circuits on the load and the specified conductor cross-sections and lengths:

Rated current of the miniature circuit breaker	Example of type ¹⁾	Max. conductor cross-section	Minimum cable length from contactor to load
6 A	5SY4 106-6, 5SX2 106-6	1 mm ²	5 m
10 A	5SY4 110-6, 5SX2 110-6	1.5 mm ²	8 m
16 A	5SY4 116-6, 5SX2 116-6	1.5 mm ²	12 m
16 A	5SY4 116-6, 5SX2 116-6	2.5 mm ²	20 m
20 A	5SY4 120-6, 5SX2 120-6	2.5 mm ²	20 m
25 A	5SY4 125-6, 5SX2 125-6	2.5 mm ²	26 m

¹⁾ The miniature circuit breakers can be used up to a maximum rated voltage of 480 V!

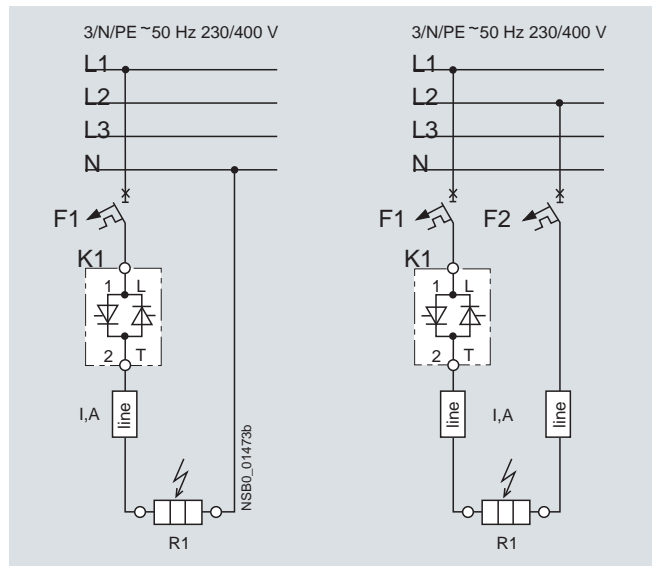

The setup and installation above can also be used for the solid-state relays with a I^2t value of at least 6600 A²s.

Three-phase versions

The three-phase solid-state contactors for resistive loads up to 50 A are available with

- Two-phase control (suitable in particular for circuits without connection to the neutral conductor) and
- Three-phase control (suitable for star circuits with connection to the neutral conductor or for applications in which the system requires all phases to be switched)

The converter function module can be snapped onto both versions for the simple power control of AC loads by means of analog signals.

- Check the correct contactor size with the aid of the rated current diagram, taking account of the installation conditions



Solid-State Switching Devices for Resistive Loads

Solid-State Contactors

SIRIUS 3RF23 solid-state contactors, single-phase

Technical specifications

Order No.	3RF23 ..-A...	3RF23 ..-B...	3RF23 ..-C...	3RF23 ..-D...
Dimensions (W x H x D)	See overleaf			
General data				
Ambient temperature				
• During operation, derating from 40 °C	°C	-25 ... +60		
• During storage	°C	-55 ... +80		
Installation altitude	m	0 ... 1000; derating from 1000		
Shock resistance acc. to IEC 60068-2-27	g/ms	15/11		
Vibration resistance acc. to IEC 60068-2-6	g	2		
Degree of protection	IP20			
Electromagnetic compatibility (EMC)				
• Emitted interference acc. to IEC 60947-4-3				
- Conducted interference voltage	Class A for industrial applications		Class A for industrial applications; Class B for residential, business and commercial applications up to 16 A, AC-51 Low Noise	Class A for industrial applications
- Emitted, high-frequency interference voltage	Class B for residential, business and commercial applications			
• Interference immunity				
- Electrostatic discharge acc. to IEC 61000-4-2 (corresponds to degree of severity 3)	kV	Contact discharge 4; air discharge 8; behavior criterion 2		
- Induced RF fields acc. to IEC 61000-4-6	MHz	0.15 ... 80; 140 dBµV; behavior criterion 1		
- Burst acc. to IEC 61000-4-4	kV	2/5.0 kHz; behavior criterion 2		
- Surge acc. to IEC 61000-4-5	kV	Conductor - ground 2; conductor - conductor 1; behavior criterion 2		

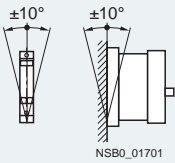
Order No.	3RF23 ..-1....	3RF23 ..-2....	3RF23 ..-3....
General data			
Connection type	 Screw terminals	 Spring-type terminals	 Ring terminal lug connections
Connection, main contacts			
• Conductor cross-section	mm ²	2 x (1.5 ... 2.5) ¹⁾ ; 2 x (2.5 ... 6) ¹⁾	2x (0.5 ... 2.5)
- Solid	mm ²	2 x (1 ... 2.5) ¹⁾ ; 2 x (2.5 ... 6) ¹⁾ ;	2x (0.5 ... 1.5)
- Finely stranded with end sleeve	mm ²	1 x 10	--
- Finely stranded without end sleeve	mm ²	2 x (AWG 14 ... 10)	2x (0.5 ... 2.5)
- Solid or stranded, AWG cables			2 x (AWG 18 ... 14)
• Terminal screw		M4	M5
• Tightening torque	Nm	2 ... 2.5	--
	lb.in	7 ... 10.3	--
• Cable lug		--	--
- DIN			DIN 46234
- JIS			-5-2.5, -5-6, -5-10, -5-16, -5-25 JIS C 2805 R 2-5, 5.5-5, 8-5, 14-5
Connection, auxiliary/control contacts			
• Conductor cross-section	mm	1 x (0.5 ... 2.5) ¹⁾ , 2 x (0.5 ... 1.0)	1 x (0.5 ... 2.5), 2 x (0.5 ... 1.0)
	AWG	AWG 20 ... 12	AWG 20 ... 12
• Stripped length	mm	7	7
• Terminal screw		M3	M3
• Tightening torque	Nm	0.5 ... 0.6	0.5 ... 0.6
	lb.in	4.5 ... 5.3	4.5 ... 5.3
Grounding screw²⁾			
• Size (standard screw)		M4	M4
Permissible mounting positions			
			

¹⁾ If two different conductor cross-sections are connected to one clamping point, both cross-sections must lie in the range specified. If identical cross-sections are used, this restriction does not apply.

²⁾ The screw is not included in the scope of supply.

Solid-State Switching Devices for Resistive Loads

Solid-State Contactors

SIRIUS 3RF23 solid-state contactors, single-phase

Type		3RF23 ..-...2	3RF23 ..-...4	3RF23 ..-...5	3RF23 ..-...6
Main circuit					
Rated operational voltage U_e	V AC	24 ... 230	48 ... 460	48 ... 600	48 ... 600
• Operating range	V AC	20 ... 253	40 ... 506	40 ... 660	40 ... 660
• Rated frequency	Hz	50/60 ± 10 %			
Rated insulation voltage U_i	V	600			
Blocking voltage	V	800	1200		1600
Rate of voltage rise	V/μs	1000			

Type		3RF23 ..-...0.	3RF23 ..-...1.	3RF23 ..-...2.	3RF23 ..-...4.
Control circuit					
Method of operation		DC operation	AC/DC operation	AC operation	DC operation
Rated control supply voltage U_s	V	24 DC acc. to EN 61131-2	24 AC 24 DC	110 ... 230 AC	4 ... 30 DC
Rated frequency of the control supply voltage	Hz	--	50/60 ± 10%	50/60 ± 10%	--
Actuating voltage, max.	V	30	26.5 AC 30 DC	253	30
Typical actuating current	mA	20/Low Power: 10^{1}	20 20	15	20
Response voltage	V	15	14 AC 15 DC	90	4
Drop-out voltage	V	5	5 AC 55 DC	40	1
Operating times					
• ON-delay	ms	1 + max. one half-wave ²⁾	10 + max. one half-wave ²⁾	40 + max. one half-wave ²⁾	1 + max. one half-wave ²⁾
• OFF-delay	ms	1 + max. one half-wave	15 + max. one half-wave	40 + max. one half-wave	1 + max. one half-wave

¹⁾ Applies to the version "Low Power" 3RF23 ..-AA..-0KNO

²⁾ Only for zero-point-switching devices.

Order No.	Type current AC-51 ¹⁾	Dimensions (W x H x D) (including heat sink)
	A	mm

Main circuit		
3RF23 10-AA..	10.5	22.5 x 100 x 89
3RF23 20-AA..	20	22.5 x 100 x 135.5
3RF23 20-CA..		
3RF23 20-DA..		
3RF23 30-AA..	30	30 x 100 x 151
3RF23 30-CA..		
3RF23 30-DA..	30	22.5 x 100 x 135.5

Order No.	Type current AC-51 ¹⁾	Dimensions (W x H x D) (including heat sink)
	A	mm

Main circuit		
3RF23 40-AA..	40	67 x 100 x 151
3RF23 50-AA..	50	67 x 100 x 151
3RF23 70-AA..	70	135 x 100 x 157.5
3RF23 90-AA..	88	180 x 200 x 157.5

¹⁾ The type current provides information about the performance of the solid-state contactor. The actual permitted rated operational current I_e can be smaller depending on the connection method and start-up conditions.

Solid-State Switching Devices for Resistive Loads

Solid-State Contactors

SIRIUS 3RF23 solid-state contactors, single-phase

Order No.	Type current AC-51 ¹⁾			Power loss at I_{max}	Minimum load current	Leakage current	Rated impulse withstand capacity I_{tsm}	I^2t value
	For I_{max} at 40 °C	Acc. to IEC 60947-4-3 for 40 °C	Acc. to UL/CSA for 50 °C					
	A	A	A	W	A	mA	A	A ² s
Main circuit								
3RF23 10-AA.2 3RF23 10-AA.4 3RF23 10-AA.5 3RF23 10-AA.6	10.5	7.5	9.6	11	0.1	10	200 200 200 400	200 200 200 800
3RF23 20-AA.2 3RF23 20-AA.4 3RF23 20-AA.5 3RF23 20-AA.6 3RF23 20-CA.2 3RF23 20-CA.4 3RF23 20-DA.2 3RF23 20-DA.4	20	13.2	17.6	20	0.5	10 10 10 10 25 25 10 10	600 600 600 600 600 600 1150 1150	1800 1800 1800 1800 1800 1800 6600 6600
3RF23 30-AA.2 3RF23 30-AA.4 3RF23 30-AA.5 3RF23 30-AA.6 3RF23 30-CA.2 3RF23 30-DA.4	30	22	27	33	0.5	10 10 10 10 25 10	600 600 600 600 600 1150	1800 1800 1800 1800 1800 6600
3RF23 40-AA.2 3RF23 40-AA.4 3RF23 40-AA.5 3RF23 40-AA.6	40	33	36	44	0.5	10	1200 1200 1200 1150	7200 7200 7200 6600
3RF23 50-AA.2 3RF23 50-AA.4 3RF23 50-AA.5 3RF23 50-AA.6	50	36	45	54	0.5	10	1150	6600
3RF23 70-AA.2 3RF23 70-AA.4 3RF23 70-AA.5 3RF23 70-AA.6	70	70	62	83	0.5	10	1150	6600
3RF23 90-AA.2 3RF23 90-AA.4 3RF23 90-AA.5 3RF23 90-AA.6	88	88	80	117	0.5	10	1150	6600

¹⁾ The type current provides information about the performance of the solid-state contactor. The actual permitted rated operational current I_e can be smaller depending on the connection method and start-up conditions.

Order No.	Type current AC-51 ¹⁾			Type current AC-15		Power loss at I_{max}	Minimum load current	Leakage current	Rated impulse withstand capacity I_{tsm}	I^2t value
	For I_{max} at 40 °C	Acc. to IEC 60947-4-3 for 40 °C	Acc. to UL/CSA for 50 °C	$10 \times I_e$ for 60 ms	Parameters					
	A	A	A	A		W	A	mA	A	A ² s
Main circuit										
3RF23 10-BA.2 3RF23 10-BA.4 3RF23 10-BA.6	10.5	7.5	9.6	6	1200 1/h 50 % ON period	11	0.1	10	200 200 400	200 200 800
3RF23 20-BA.2 3RF23 20-BA.4 3RF23 20-BA.6	20	13.2	17.6	12	1200 1/h 50 % ON period	20	0.5	10	600	1800
3RF23 30-BA.2 3RF23 30-BA.4 3RF23 30-BA.6	30	22	27	15	1200 1/h 50 % ON period	33	0.5	10	600	1800
3RF23 40-BA.2 3RF23 40-BA.4 3RF23 40-BA.6	40	33	36	20	1200 1/h 50 % ON period	44	0.5	10	1200 1200 1150	7200 7200 6600
3RF23 50-BA.2 3RF23 50-BA.4 3RF23 50-BA.6	50	36	45	25	1200 1/h 50 % ON period	54	0.5	10	1150	6600
3RF23 70-BA.2 3RF23 70-BA.4 3RF23 70-BA.6	70	70	62	27.5	1200 1/h 50 % ON period	83	0.5	10	1150	6600
3RF23 90-BA.2 3RF23 90-BA.4 3RF23 90-BA.6	88	88	80	30	1200 1/h 50 % ON period	117	0.5	10	1150	6600

¹⁾ The type current provides information about the performance of the solid-state contactor. The actual permitted rated operational current I_e can be smaller depending on the connection method and start-up conditions.

Solid-State Switching Devices for Resistive Loads

Solid-State Contactors

**SIRIUS 3RF23 solid-state contactors,
single-phase**

Circuit diagrams

DC control supply voltage

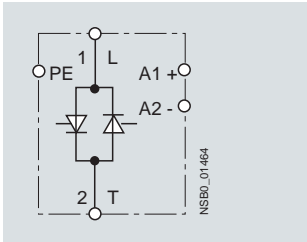

AC control supply voltage

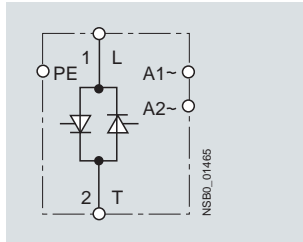



Selection and ordering data

Selection notes

The solid-state contactors are selected on the basis of details of the network, the load and the ambient conditions. As the solid-state contactors are already equipped with an optimally matched heat sink, the selection process is considerably simpler than that for solid-state relays.

The following procedure is recommended:

- Determine the rated current of the load and the mains voltage
- Select a solid-state contactor with the same or higher rated current than the load

Type current ¹⁾ I_{max}	Rated control supply voltage U_c	DT	Screw terminals	⊕ PU (UNIT, SET, M)	PS*	PG	
A	V		Order No.	Price per PU			
Zero-point switching Rated operational voltage U_e 24 ... 230 V AC							
	10.5	24 DC acc. to EN 61131-2	A	3RF23 10-1AA02	1	1 unit	101
	20		A	3RF23 20-1AA02	1	1 unit	101
	30		A	3RF23 30-1AA02	1	1 unit	101
	40		A	3RF23 40-1AA02	1	1 unit	101
	50		A	3RF23 50-1AA02	1	1 unit	101
	20	24 DC Low Power	A	3RF23 20-1AA02-0KN0	1	1 unit	101
	10.5	24 AC/DC	A	3RF23 10-1AA12	1	1 unit	101
	10.5	110 ... 230 AC	A	3RF23 10-1AA22	1	1 unit	101
	20		A	3RF23 20-1AA22	1	1 unit	101
	30		A	3RF23 30-1AA22	1	1 unit	101
40		A	3RF23 40-1AA22	1	1 unit	101	
50		A	3RF23 50-1AA22	1	1 unit	101	
Zero-point switching Rated operational voltage U_e 48 ... 460 V AC							
	10.5	24 DC acc. to EN 61131-2	A	3RF23 10-1AA04	1	1 unit	101
	20		A	3RF23 20-1AA04	1	1 unit	101
	30		A	3RF23 30-1AA04	1	1 unit	101
	40		A	3RF23 40-1AA04	1	1 unit	101
	50		A	3RF23 50-1AA04	1	1 unit	101
	10.5	24 DC Low Power	A	3RF23 10-1AA04-0KN0	1	1 unit	101
	10.5	24 AC/DC	A	3RF23 10-1AA14	1	1 unit	101
	20		B	3RF23 20-1AA14	1	1 unit	101
	30		A	3RF23 30-1AA14	1	1 unit	101
	40		B	3RF23 40-1AA14	1	1 unit	101
	50		B	3RF23 50-1AA14	1	1 unit	101
	10.5	110 ... 230 AC	A	3RF23 10-1AA24	1	1 unit	101
	20		A	3RF23 20-1AA24	1	1 unit	101
	30		A	3RF23 30-1AA24	1	1 unit	101
	40		A	3RF23 40-1AA24	1	1 unit	101
	50		A	3RF23 50-1AA24	1	1 unit	101
	10.5	4 ... 30 DC	B	3RF23 10-1AA44	1	1 unit	101
	20		A	3RF23 20-1AA44	1	1 unit	101
	30		A	3RF23 30-1AA44	1	1 unit	101

Other rated control supply voltages on request.

¹⁾ The type current provides information about the performance of the solid-state contactor. The actual permitted rated operational current I_e can be smaller depending on the connection method and start-up conditions. For derating see the manual, "Characteristic curves".

Solid-State Switching Devices for Resistive Loads

Solid-State Contactors

SIRIUS 3RF23 solid-state contactors, single-phase

Type current ¹⁾ I_{max}	Rated control supply voltage U_s	DT	Screw terminals	PU (UNIT, SET, M)	PS*	PG
A	V		Order No.	Price per PU		
Zero-point switching Rated operational voltage U_e 48 ... 600 V AC						
30	110 ... 230 AC	B	3RF23 30-1AA25	1	1 unit	101
10.5	4 ... 30 DC	B	3RF23 10-1AA45	1	1 unit	101
20		A	3RF23 20-1AA45	1	1 unit	101
30		A	3RF23 30-1AA45	1	1 unit	101
40		A	3RF23 40-1AA45	1	1 unit	101
50		A	3RF23 50-1AA45	1	1 unit	101
Zero-point switching · Blocking voltage 1600 V Rated operational voltage U_e 48 ... 600 V AC						
10.5	24 DC acc. to EN 61131-2	B	3RF23 10-1AA06	1	1 unit	101
20		A	3RF23 20-1AA06	1	1 unit	101
30		A	3RF23 30-1AA06	1	1 unit	101
40		B	3RF23 40-1AA06	1	1 unit	101
50		B	3RF23 50-1AA06	1	1 unit	101
10.5	110 ... 230 AC	B	3RF23 10-1AA26	1	1 unit	101
20		B	3RF23 20-1AA26	1	1 unit	101
30		B	3RF23 30-1AA26	1	1 unit	101
40		B	3RF23 40-1AA26	1	1 unit	101
50		B	3RF23 50-1AA26	1	1 unit	101
Low noise²⁾ · Zero-point switching Rated operational voltage U_e 24 ... 230 V AC						
20	24 DC acc. to EN 61131-2	B	3RF23 20-1CA02	1	1 unit	101
30		B	3RF23 30-1CA02	1	1 unit	101
20	110 ... 230 AC	B	3RF23 20-1CA22	1	1 unit	101
Low noise²⁾ · Zero-point switching Rated operational voltage U_e 48 ... 460 V AC						
20	24 DC acc. to EN 61131-2	B	3RF23 20-1CA04	1	1 unit	101
20	110 ... 230 AC	B	3RF23 20-1CA24	1	1 unit	101
20	4 ... 30 DC	A	3RF23 20-1CA44	1	1 unit	101
Short-circuit proof with B-type MCB, zero-point switching Rated operational voltage U_e 24 ... 230 V AC						
20	24 DC acc. to EN 61131-2	A	3RF23 20-1DA02	1	1 unit	101
20	110 ... 230 AC	B	3RF23 20-1DA22	1	1 unit	101
Short-circuit proof with B-type MCB, zero-point switching Rated operational voltage U_e 48 ... 460 V AC						
20	24 DC acc. to EN 61131-2	A	3RF23 20-1DA04	1	1 unit	101
20	110 ... 230 AC	B	3RF23 20-1DA24	1	1 unit	101
20	4 ... 30 DC	A	3RF23 20-1DA44	1	1 unit	101
30		A	3RF23 30-1DA44	1	1 unit	101

3RF23 40-1

3RF23 20-1

3RF23 20-1

Other rated control supply voltages on request.



¹⁾ The type current provides information about the performance of the solid-state contactor. The actual permitted rated operational current I_e can be smaller depending on the connection method and start-up conditions. For derating see the manual, "Characteristic curves".

²⁾ See page 4/77.

Solid-State Switching Devices for Resistive Loads

Solid-State Contactors

SIRIUS 3RF23 solid-state contactors, single-phase

Type current ¹⁾ I_{max}	Operational current I_e / AC-15 ²⁾	Rated control supply voltage U_s	DT	Screw terminals	⊕	PU (UNIT, SET, M)	PS*	PG	
A	A	V		Order No.		Price per PU			
Instantaneous switching Rated operational voltage U_e 24 ... 230 V AC									
 3RF23 10-1	10.5	6	24 DC acc. to EN 61131-2	A	3RF23 10-1BA02		1	1 unit	101
	20	12		A	3RF23 20-1BA02		1	1 unit	101
	30	15		B	3RF23 30-1BA02		1	1 unit	101
	40	20		B	3RF23 40-1BA02		1	1 unit	101
	50	25		B	3RF23 50-1BA02		1	1 unit	101
	50	27.5		B	3RF23 70-1BA02		1	1 unit	101
	50	30		B	3RF23 90-1BA02		1	1 unit	101
	10.5	6	110 ... 230 AC	B	3RF23 10-1BA22		1	1 unit	101
	20	12		B	3RF23 20-1BA22		1	1 unit	101
	30	15		B	3RF23 30-1BA22		1	1 unit	101
	40	20		B	3RF23 40-1BA22		1	1 unit	101
	50	25		B	3RF23 50-1BA22		1	1 unit	101
	50	27.5		B	3RF23 70-1BA22		1	1 unit	101
	50	30		B	3RF23 90-1BA22		1	1 unit	101
Instantaneous switching Rated operational voltage U_e 48 ... 460 V AC									
 3RF23 20-1	10.5	6	24 DC acc. to EN 61131-2	A	3RF23 10-1BA04		1	1 unit	101
	20	12		A	3RF23 20-1BA04		1	1 unit	101
	30	15		A	3RF23 30-1BA04		1	1 unit	101
	40	20		B	3RF23 40-1BA04		1	1 unit	101
	50	25		B	3RF23 50-1BA04		1	1 unit	101
	50	27.5		B	3RF23 70-1BA04		1	1 unit	101
	50	30		B	3RF23 90-1BA04		1	1 unit	101
	10.5	6	110 ... 230 AC	B	3RF23 10-1BA24		1	1 unit	101
	20	12		B	3RF23 20-1BA24		1	1 unit	101
	30	15		B	3RF23 30-1BA24		1	1 unit	101
	40	20		B	3RF23 40-1BA24		1	1 unit	101
	50	25		B	3RF23 50-1BA24		1	1 unit	101
	50	27.5		B	3RF23 70-1BA24		1	1 unit	101
	50	30		B	3RF23 90-1BA24		1	1 unit	101
20	12	4 ... 30 DC	B	3RF23 20-1BA44		1	1 unit	101	
30	15		B	3RF23 30-1BA44		1	1 unit	101	
50	25		B	3RF23 50-1BA44		1	1 unit	101	
Instantaneous switching · Blocking voltage 1600 V Rated operational voltage U_e 48 ... 600 V AC									
 3RF23 40-1	10.5	6	24 DC acc. to EN 61131-2	B	3RF23 10-1BA06		1	1 unit	101
	20	12		A	3RF23 20-1BA06		1	1 unit	101
	30	15		B	3RF23 30-1BA06		1	1 unit	101
	40	20		B	3RF23 40-1BA06		1	1 unit	101
	50	25		B	3RF23 50-1BA06		1	1 unit	101
	50	27.5		B	3RF23 70-1BA06		1	1 unit	101
	50	30		B	3RF23 90-1BA06		1	1 unit	101
	10.5	6	110 ... 230 AC	B	3RF23 10-1BA26		1	1 unit	101
	20	12		B	3RF23 20-1BA26		1	1 unit	101
	30	15		B	3RF23 30-1BA26		1	1 unit	101
	40	20		B	3RF23 40-1BA26		1	1 unit	101
	50	25		B	3RF23 50-1BA26		1	1 unit	101
	50	27.5		B	3RF23 70-1BA26		1	1 unit	101
	50	30		B	3RF23 90-1BA26		1	1 unit	101

Other rated control supply voltages on request.

¹⁾ The type current provides information about the performance of the solid-state contactor. The actual permitted rated operational current I_e can be smaller depending on the connection method and start-up conditions. For derating see the manual, "Characteristic curves".

²⁾ Utilization category AC-15:
Electromagnetic loads, e.g. valves according to EN 60947-5.
Parameters: max. 1200 1/h, 50 % ON Period, 10-times inrush current for 60 ms.

Solid-State Switching Devices for Resistive Loads

Solid-State Contactors

SIRIUS 3RF23 solid-state contactors, single-phase



3RF23 20-2

Type current ¹⁾ I_{max}	Rated control supply voltage U_s	DT	Spring-type terminals	PU (UNIT, SET, M)	PS*	PG
A	V		Order No.	Price per PU		
Zero-point switching Rated operational voltage U_e 24 ... 230 V AC						
10.5	24 DC acc. to EN 61131-2	B	3RF23 10-2AA02	1	1 unit	101
20		A	3RF23 20-2AA02	1	1 unit	101
10.5	110 ... 230 AC	B	3RF23 10-2AA22	1	1 unit	101
20		B	3RF23 20-2AA22	1	1 unit	101
Zero-point switching Rated operational voltage U_e 48 ... 460 V AC						
10.5	24 DC acc. to EN 61131-2	A	3RF23 10-2AA04	1	1 unit	101
20		A	3RF23 20-2AA04	1	1 unit	101
10.5	110 ... 230 AC	B	3RF23 10-2AA24	1	1 unit	101
20		B	3RF23 20-2AA24	1	1 unit	101
Zero-point switching · Blocking voltage 1600 V Rated operational voltage U_e 48 ... 600 V AC						
10.5	24 DC acc. to EN 61131-2	B	3RF23 10-2AA06	1	1 unit	101
20		A	3RF23 20-2AA06	1	1 unit	101
10.5	110 ... 230 AC	B	3RF23 10-2AA26	1	1 unit	101
20		B	3RF23 20-2AA26	1	1 unit	101
Low noise²⁾ · Zero-point switching Rated operational voltage U_e 24 ... 230 V AC						
20	24 DC acc. to EN 61131-2	B	3RF23 20-2CA02	1	1 unit	101
20	110 ... 230 AC	B	3RF23 20-2CA22	1	1 unit	101
Low noise²⁾ · Zero-point switching Rated operational voltage U_e 48 ... 460 V AC						
20	24 DC acc. to EN 61131-2	B	3RF23 20-2CA04	1	1 unit	101
20	110 ... 230 AC	B	3RF23 20-2CA24	1	1 unit	101
Short-circuit proof with B-type MCB, zero-point switching Rated operational voltage U_e 24 ... 230 V AC						
20	110 ... 230 AC	B	3RF23 20-2DA22	1	1 unit	101
Short-circuit proof with B-type MCB, zero-point switching Rated operational voltage U_e 48 ... 460 V AC						
20	24 DC acc. to EN 61131-2	B	3RF23 20-2DA04	1	1 unit	101
20	110 ... 230 AC	B	3RF23 20-2DA24	1	1 unit	101

Other rated control supply voltages on request.

¹⁾ The type current provides information about the performance of the solid-state contactor. The actual permitted rated operational current I_e can be smaller depending on the connection method and start-up conditions. For derating see the manual, "Characteristic curves".

²⁾ See page 4/77.

Solid-State Switching Devices for Resistive Loads

Solid-State Contactors

SIRIUS 3RF23 solid-state contactors, single-phase

Type current ¹⁾ I_{max}	Rated control supply voltage U_s	DT	Ring terminal lug connection	PU (UNIT, SET, M)	PS*	PG	
A	V		Order No.	Price per PU			
Zero-point switching Rated operational voltage U_e 24 ... 230 V AC							
 3RF23 30-3	10.5	24 DC acc. to EN 61131-2	B	3RF23 10-3AA02	1	1 unit	101
	20		B	3RF23 20-3AA02	1	1 unit	101
	30		B	3RF23 30-3AA02	1	1 unit	101
	40		B	3RF23 40-3AA02	1	1 unit	101
	50		B	3RF23 50-3AA02	1	1 unit	101
	70		A	3RF23 70-3AA02	1	1 unit	101
	88		B	3RF23 90-3AA02	1	1 unit	101
	10.5	110 ... 230 AC	B	3RF23 10-3AA22	1	1 unit	101
	20		B	3RF23 20-3AA22	1	1 unit	101
	30		B	3RF23 30-3AA22	1	1 unit	101
	40		B	3RF23 40-3AA22	1	1 unit	101
	50		B	3RF23 50-3AA22	1	1 unit	101
	70		B	3RF23 70-3AA22	1	1 unit	101
	88		B	3RF23 90-3AA22	1	1 unit	101
Zero-point switching Rated operational voltage U_e 48 ... 460 V AC							
10.5	24 DC acc. to EN 61131-2	B	3RF23 10-3AA04	1	1 unit	101	
20		B	3RF23 20-3AA04	1	1 unit	101	
30		A	3RF23 30-3AA04	1	1 unit	101	
40		B	3RF23 40-3AA04	1	1 unit	101	
50		A	3RF23 50-3AA04	1	1 unit	101	
70		A	3RF23 70-3AA04	1	1 unit	101	
88		A	3RF23 90-3AA04	1	1 unit	101	
10.5	110 ... 230 AC	B	3RF23 10-3AA24	1	1 unit	101	
20		B	3RF23 20-3AA24	1	1 unit	101	
30		B	3RF23 30-3AA24	1	1 unit	101	
40		B	3RF23 40-3AA24	1	1 unit	101	
50		B	3RF23 50-3AA24	1	1 unit	101	
70		B	3RF23 70-3AA24	1	1 unit	101	
88		B	3RF23 90-3AA24	1	1 unit	101	
20	4 ... 30 DC	B	3RF23 20-3AA44	1	1 unit	101	
30		B	3RF23 30-3AA44	1	1 unit	101	
50		B	3RF23 50-3AA44	1	1 unit	101	
Zero-point switching Rated operational voltage U_e 48 ... 600 V AC							
40	4 ... 30 DC	B	3RF23 40-3AA45	1	1 unit	101	
70		A	3RF23 70-3AA45	1	1 unit	101	
88		B	3RF23 90-3AA45	1	1 unit	101	
Zero-point switching - Blocking voltage 1600 V Rated operational voltage U_e 48 ... 600 V AC							
10.5	24 DC acc. to EN 61131-2	B	3RF23 10-3AA06	1	1 unit	101	
20		B	3RF23 20-3AA06	1	1 unit	101	
30		B	3RF23 30-3AA06	1	1 unit	101	
40		B	3RF23 40-3AA06	1	1 unit	101	
50		B	3RF23 50-3AA06	1	1 unit	101	
70		B	3RF23 70-3AA06	1	1 unit	101	
88		B	3RF23 90-3AA06	1	1 unit	101	
10.5	110 ... 230 AC	B	3RF23 10-3AA26	1	1 unit	101	
20		B	3RF23 20-3AA26	1	1 unit	101	
30		B	3RF23 30-3AA26	1	1 unit	101	
40		B	3RF23 40-3AA26	1	1 unit	101	
50		B	3RF23 50-3AA26	1	1 unit	101	
70		A	3RF23 70-3AA26	1	1 unit	101	
88		B	3RF23 90-3AA26	1	1 unit	101	

Other rated control supply voltages on request.

¹⁾ The type current provides information about the performance of the solid-state contactor. The actual permitted rated operational current I_e can be smaller depending on the connection method and start-up conditions. For derating see the manual, "Characteristic curves".

Solid-State Switching Devices for Resistive Loads

Solid-State Contactors



SIRIUS 3RF23 solid-state contactors, single-phase

Type current ¹⁾ I_{max}	Operational current I_e / AC-15 ²⁾	Rated control supply voltage U_s	DT	Ring terminal lug connection	PU (UNIT, SET, M)	PS*	PG
A	A	V		Order No.	Price per PU		
Instantaneous switching Rated operational voltage U_e 24 ... 230 V AC							
70	27.5	24 DC acc. to EN 61131-2	B	3RF23 70-3BA02	1	1 unit	101
88	30		B	3RF23 90-3BA02	1	1 unit	101
70	27.5	110 ... 230 AC	B	3RF23 70-3BA22	1	1 unit	101
88	30		B	3RF23 90-3BA22	1	1 unit	101
Instantaneous switching Rated operational voltage U_e 48 ... 460 V AC							
70	27.5	24 DC acc. to EN 61131-2	B	3RF23 70-3BA04	1	1 unit	101
88	30		B	3RF23 90-3BA04	1	1 unit	101
70	27.5	110 ... 230 AC	B	3RF23 70-3BA24	1	1 unit	101
88	30		B	3RF23 90-3BA24	1	1 unit	101
Instantaneous switching · Blocking voltage 1600 V Rated operational voltage U_e 48 ... 600 V AC							
70	27.5	24 DC acc. to EN 61131-2	B	3RF23 70-3BA06	1	1 unit	101
88	30		B	3RF23 90-3BA06	1	1 unit	101
70	27.5	110 ... 230 AC	B	3RF23 70-3BA26	1	1 unit	101
88	30		B	3RF23 90-3BA26	1	1 unit	101
Short-circuit proof with B-type MCB, zero-point switching Rated operational voltage U_e 24 ... 230 V AC							
20	--	24 DC acc. to EN 61131-2	B	3RF23 20-3DA02	1	1 unit	101
20	--	110 ... 230 AC	B	3RF23 20-3DA22	1	1 unit	101
Short-circuit proof with B-type MCB, zero-point switching Rated operational voltage U_e 48 ... 460 V AC							
20	--	24 DC acc. to EN 61131-2	B	3RF23 20-3DA04	1	1 unit	101
20	--	110 ... 230 AC	B	3RF23 20-3DA24	1	1 unit	101

Other rated control supply voltages on request.

¹⁾ The type current provides information about the performance of the solid-state contactor. The actual permitted rated operational current I_e can be smaller depending on the connection method and start-up conditions. For derating see the manual, "Characteristic curves".

²⁾ Utilization category AC-15:
Electromagnetic loads, e.g. valves according to EN 60947-5.
Parameters: max. 1200 1/h, 50 % ON Period, 10-times inrush current for 60 ms.



Version	DT	Order No.	Price per PU	PU (UNIT, SET, M)	PS*	PG
Optional accessories						
Spring-type terminals 						
 3RA29 08-1A	A	3RA29 08-1A		1	1 unit	101
Terminal covers for 3RF21 solid-state relays and 3RF23 solid-state contactors in ring terminal lug connection (After simple adaptation, this terminal cover can also be used for screw connection).						
 3RF29 00-3PA88	A	3RF29 00-3PA88		1	10 units	101

Solid-State Switching Devices for Resistive Loads

Solid-State Contactors

SIRIUS 3RF24 solid-state contactors,
three-phase

Technical specifications

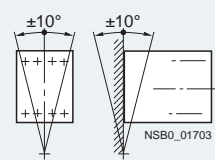
Order No.	3RF24 ...-1....	3RF24 ...-2....	3RF24 ...-3....
Dimensions (W x H x D)	See overleaf		
General data			
Ambient temperature			
• During operation, derating from 40 °C	°C	-25 ... +60	
• During storage	°C	-55 ... +80	
Installation altitude	m	0 ... 1000; derating from 1000	
Shock resistance acc. to IEC 60068-2-27	g/ms	15/11	
Vibration resistance acc. to IEC 60068-2-6	g	2	
Degree of protection	IP20		
Insulation strength at 50/60 Hz (main/control circuit to floor)	V rms	4000	
Electromagnetic compatibility (EMC)			
• Emitted interference acc. to IEC 60947-4-3 - Conducted interference voltage	Class A for industrial applications ¹⁾		
• Interference immunity - Electrostatic discharge acc. to IEC 61000-4-2 (corresponds to degree of severity 3)	kV	Contact discharge 4; air discharge 8; behavior criterion 2	
- Induced RF fields acc. to IEC 61000-4-6	MHz	0.15 ... 80; 140 dBµV; behavior criterion 1	
- Burst acc. to IEC 61000-4-4	kV	2/5.0 kHz; behavior criterion 2	
- Surge acc. to IEC 61000-4-5	kV	Conductor - ground 2; conductor - conductor 1; behavior criterion 2	
Connection type	 Screw terminals	 Spring-type terminals	 Ring terminal lug connection
Connection, main contacts			
• Conductor cross-section	mm ²	2 x (1.5 ... 2.5) ²⁾ ; 2 x (2.5 ... 6) ²⁾	2x (0.5 ... 2.5)
- Solid	mm ²	2 x (1 ... 2.5) ²⁾ ; 2 x (2.5 ... 6) ²⁾ ;	2x (0.5 ... 1.5)
- Finely stranded with end sleeve	mm ²	1 x 10	--
- Finely stranded without end sleeve	mm ²	--	2x (0.5 ... 2.5)
- Solid or stranded, AWG cables	mm	2 x (AWG 14 ... 10)	2 x (AWG 18 ... 14)
• Stripped length	mm	10	10
• Terminal screw	Mm	M4	--
- Tightening torque	lb.in	2 ... 2.5 18 ... 22	M5 2 ... 2.5 18 ... 22
• Cable lug	--	--	--
- Acc. to DIN 46234	--	--	5-2.5 ... 5-25
- Acc. to JIS C 2805	--	--	R 2.5 ... 14-5
Connection, auxiliary/control contacts			
• Conductor cross-section	mm AWG	1 x (0.5 ... 2.5), 2 x (0.5 ... 1.0) AWG 20 ... 12	0.5 ... 2.5 AWG 20 ... 12
• Stripped length	mm	7	10
• Terminal screw	Mm	M3	--
- Tightening torque, Ø 3.5 mm, PZ 1	lb.in	0.5 ... 0.6 4.5 ... 5.3	M3 0.5 ... 0.6 4.5 ... 5.3
Grounding screw³⁾			
• Size (standard screw)	Mm	M4	M4
Permissible mounting positions			
			

¹⁾ These products were built as Class A devices. The use of these devices in residential areas could result in lead in radio interference. In this case these may be required to introduce additional interference suppression measures. The versions 3RF24...-1AC55 comply with Class B for residential, business and commercial applications

²⁾ If two different conductor cross-sections are connected to one clamping point, both cross-sections must lie in the range specified. If identical cross-sections are used, this restriction does not apply.

³⁾ The screw is not included in the scope of supply.

Solid-State Switching Devices for Resistive Loads

Solid-State Contactors

SIRIUS 3RF24 solid-state contactors, three-phase

Order No.	Type current	Rated operational current I_e		Power loss at	Minimum load current	Max. leakage current	Rated impulse withstand capacity I_{tsm}	I^2t value
	I_{AC-51} at 40 °C	Acc. to IEC 60947-4-3 for 40 °C	Acc. to UL/CSA for 50 °C	I_{AC-51}	A	mA	A	A ² s
Main circuit								
3RF24 10-.AB.5	10.5	7	7	23	0.1	10	200	200
3RF24 20-.AB.5	22	15	15	44	0.5	10	600	1800
3RF24 30-.AB.5	30	22	22	61	0.5	10	1200	7200
3RF24 40-.AB.5	40	30	30	80	0.5	10	1150	6600
3RF24 50-.AB.5	50	38	38	107	0.5	10	1150	6600
3RF24 10-.AC.5	10.5	7	7	31	0.1	10	300	450
3RF24 20-.AC.5	22	15	15	66	0.5	10	600	1800
3RF24 30-.AC.5	30	22	22	91	0.5	10	1200	7200
3RF24 40-.AC.5	40	30	30	121	0.5	10	1150	6600
3RF24 50-.AC.5	50	38	38	160	0.5	10	1150	6600

¹⁾ The type current provides information about the performance of the solid-state contactor. The actual permitted rated operational current I_e can be smaller depending on the connection method and start-up conditions.

Order No.	Type current AC-51	Dimensions W x H x D (including heat sink)
A	A	mm

Main circuit		
3RF24 10-.AB..	10.5	45 x 100 x 105
3RF24 10-.AC..		
3RF24 20-.AB..	22	67 x 100 x 112.5
3RF24 20-.AC..	22	89.5 x 100 x 112.5
3RF24 30-.AB..	30	

Order No.	Type current AC-51	Dimensions W x H x D (including heat sink)
A	A	mm

Main circuit		
3RF24 30-.AC..	30	113.5 x 100 x 121
3RF24 40-.AB..	40	
3RF24 40-.AC..	40	157.5 x 100 x 121
3RF24 50-.AB..	50	
3RF24 50-.AC..	50	157.5 x 180 x 121

Type	3RF24 ...-AB.5		3RF24 ...-AC.5	
Main circuit				
Controlled phases		2-phase		3-phase
Rated operational voltage U_e	V AC	48 ... 600		48 ... 600
• Operating range	V AC	40 ... 660		40 ... 660
• Rated frequency	Hz	50/60 ± 10 %		50/60 ± 10 %
Rated insulation voltage U_i	V	600		600
Rated impulse withstand voltage U_{imp}	kV	6		6
Blocking voltage	V	1200		1200
Rage of voltage rise	V/μs	1000		1000

Type	3RF24 ...-...3.		3RF24 ...-...4.		3RF24 ...-...5.	
Control circuit						
Method of operation		AC operation		DC operation		AC operation
Rated control supply voltage U_s	V	110		4 ... 30		190 ... 230
Rated frequency of the control supply voltage	Hz	50/60 ± 10 %		--		50/60 ± 10 %
Actuating voltage, max.	V	121		30		253
Typical actuating current	mA	15		30		15
Response voltage	V	90		4		180
Drop-out voltage	V	< 40		< 1		< 40
Operating times						
• ON-delay	ms	40 + max. one half-wave		1 + max. one half-wave		40 + max. one half-wave
• OFF-delay	ms	40 + max. one half-wave		1 + max. one half-wave		40 + max. one half-wave

Solid-State Switching Devices for Resistive Loads

Solid-State Contactors

SIRIUS 3RF24 solid-state contactors, three-phase

Circuit diagrams

Two-phase controlled,
DC control supply voltage

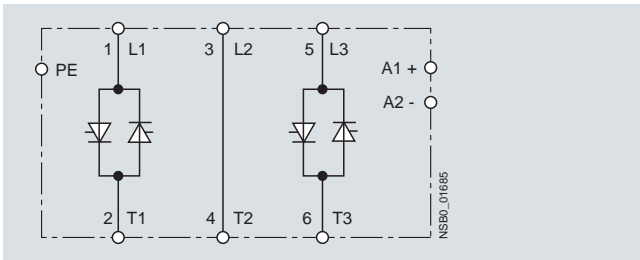

Two-phase controlled,
AC control supply voltage

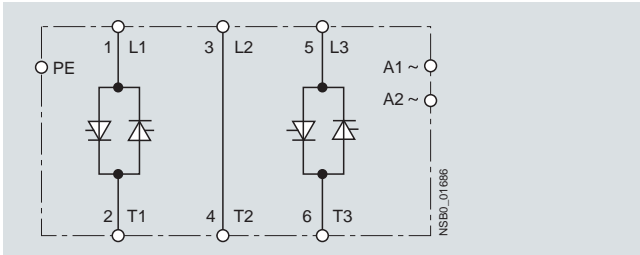

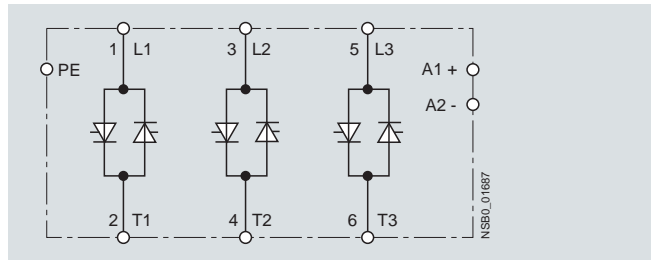

Three-phase controlled,
DC control supply voltage

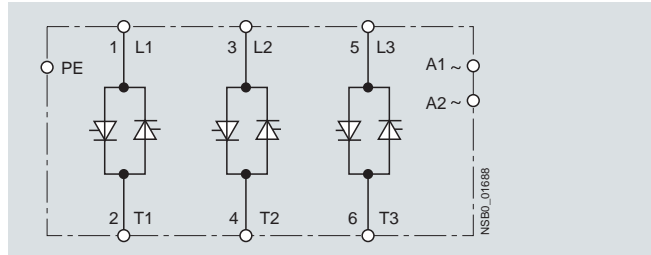

Three-phase controlled,
AC control supply voltage



Selection and ordering data

Type current ¹⁾ I_{max}	Rated control supply voltage U_s DT	Screw terminals	PU (UNIT, SET, M)	PS*	PG
A	V	Order No.	Price per PU		
Zero-point switching					
Rated operational voltage U_e 48 ... 600 V AC					
Two-phase controlled					
 3RF24 20-1AB45	10.5	4 ... 30 DC	A 3RF24 10-1AB45	1	1 unit 101
	20		A 3RF24 20-1AB45	1	1 unit 101
	30		A 3RF24 30-1AB45	1	1 unit 101
	40		B 3RF24 40-1AB45	1	1 unit 101
	50		B 3RF24 50-1AB45	1	1 unit 101
	10.5	110 AC	B 3RF24 10-1AB35	1	1 unit 101
	20		B 3RF24 20-1AB35	1	1 unit 101
	30		B 3RF24 30-1AB35	1	1 unit 101
	40		B 3RF24 40-1AB35	1	1 unit 101
	50		B 3RF24 50-1AB35	1	1 unit 101
	10.5	230 AC	B 3RF24 10-1AB55	1	1 unit 101
	20		B 3RF24 20-1AB55	1	1 unit 101
	30		B 3RF24 30-1AB55	1	1 unit 101
	40		B 3RF24 40-1AB55	1	1 unit 101
	50		B 3RF24 50-1AB55	1	1 unit 101
Three-phase controlled					
 3RF24 10-1AC45	10.5	4 ... 30 DC	A 3RF24 10-1AC45	1	1 unit 101
	20		A 3RF24 20-1AC45	1	1 unit 101
	30		A 3RF24 30-1AC45	1	1 unit 101
	40		A 3RF24 40-1AC45	1	1 unit 101
	50		A 3RF24 50-1AC45	1	1 unit 101
	10.5	110 AC	B 3RF24 10-1AC35	1	1 unit 101
	20		B 3RF24 20-1AC35	1	1 unit 101
	30		B 3RF24 30-1AC35	1	1 unit 101
	40		B 3RF24 40-1AC35	1	1 unit 101
	50		B 3RF24 50-1AC35	1	1 unit 101
	10.5	230 AC	B 3RF24 10-1AC55	1	1 unit 101
	20		B 3RF24 20-1AC55	1	1 unit 101
	30		B 3RF24 30-1AC55	1	1 unit 101
	40		B 3RF24 40-1AC55	1	1 unit 101
	50		B 3RF24 50-1AC55	1	1 unit 101

¹⁾ The type current provides information about the performance of the solid-state contactor. The actual permitted rated operational current I_e can be smaller depending on the connection method and start-up conditions. For derating see the manual, "Characteristic curves".

Solid-State Switching Devices for Resistive Loads

Solid-State Contactors

SIRIUS 3RF24 solid-state contactors, three-phase

Type current ¹⁾ I_{max}	Rated control supply voltage U_s	DT	Spring-type terminals	PU (UNIT, SET, M)	PS*	PG
A	V		Order No.	Price per PU		

Zero-point switching Rated operational voltage U_e 48 ... 600 V AC



3RF24 10-2AB45

Two-phase controlled						
10	4 ... 30 DC	B	3RF24 10-2AB45	1	1 unit	101
20	4 ... 30 DC	B	3RF24 20-2AB45	1	1 unit	101
10	230 AC	B	3RF24 10-2AB55	1	1 unit	101
20	230 AC	B	3RF24 20-2AB55	1	1 unit	101
Three-phase controlled						
10	4 ... 30 DC	B	3RF24 10-2AC45	1	1 unit	101
20	4 ... 30 DC	B	3RF24 20-2AC45	1	1 unit	101
10	230 AC	B	3RF24 10-2AC55	1	1 unit	101
20	230 AC	B	3RF24 20-2AC55	1	1 unit	101

Type current ¹⁾ I_{max}	Rated control supply voltage U_s	DT	Ring terminal lug connection	PU (UNIT, SET, M)	PS*	PG
A	V		Order No.	Price per PU		

Zero-point switching Rated operational voltage U_e 48 ... 600 V AC

Two-phase controlled						
50	4 ... 30 DC	B	3RF24 50-3AB45	1	1 unit	101
50	230 AC	B	3RF24 50-3AB55	1	1 unit	101
Three-phase controlled						
50	4 ... 30 DC	B	3RF24 50-3AC45	1	1 unit	101
50	230 AC	B	3RF24 50-3AC55	1	1 unit	101

¹⁾ The type current provides information about the performance of the solid-state contactor. The actual permitted rated operational current I_e can be smaller depending on the connection method and start-up conditions. For derating see the manual, "Characteristic curves".

Solid-State Switching Devices for Resistive Loads

3RF29 Function Modules

General data

Overview

Function modules for SIRIUS 3RF2 solid-state switching devices

A great variety of applications demand an expanded range of functionality. With our function modules, these requirements can be met really easily. The modules are mounted simply by clicking them into place; straight away the necessary connections are made with the solid-state relay or contactor.

The plug-in connection to control the solid-state switching devices can simply remain in use. The external connections have screw terminals.

The following function modules are available:

- Converters
- Load monitoring
- Heating current monitoring
- Power controllers
- Power regulators

With the exception of the converter, the function modules can be used only with single-phase solid-state switching devices.

Recommended assignment of the function modules to the 3RF21 single-phase solid-state relays

Order No.	Accessories					
	Converters	Load monitoring Basic	Extended	Heating current monitoring	Power controllers ¹⁾	Power regulators ¹⁾
Type current = 20 A						
3RF21 20-1A.02	3RF29 00-0EA18	3RF29 20-0FA08	3RF29 20-0GA13	--	3RF29 20-0KA13	3RF29 20-0HA13
3RF21 20-1A.04	3RF29 00-0EA18	3RF29 20-0FA08	3RF29 20-0GA16	3RF29 32-0JA16	3RF29 20-0KA16	3RF29 20-0HA16
3RF21 20-1A.22	--	--	3RF29 20-0GA33	--	--	--
3RF21 20-1A.24	--	--	3RF29 20-0GA36	--	--	--
3RF21 20-1A.42	3RF29 00-0EA18	3RF29 20-0FA08	3RF29 20-0GA13	--	3RF29 20-0KA13	3RF29 20-0HA13
3RF21 20-1A.45	3RF29 00-0EA18	3RF29 20-0FA08	3RF29 20-0GA16	3RF29 32-0JA16	3RF29 20-0KA16	3RF29 20-0HA16
3RF21 20-1B.04	3RF29 00-0EA18	3RF29 20-0FA08	3RF29 20-0GA16	3RF29 32-0JA16	3RF29 20-0KA16	3RF29 20-0HA16
3RF21 20-2A.02	3RF29 00-0EA18	--	--	--	--	--
3RF21 20-2A.04	3RF29 00-0EA18	--	--	--	--	--
3RF21 20-2A.22	--	--	--	--	--	--
3RF21 20-2A.24	--	--	--	--	--	--
3RF21 20-2A.42	3RF29 00-0EA18	--	--	--	--	--
3RF21 20-2A.45	3RF29 00-0EA18	--	--	--	--	--
3RF21 20-3A.02	3RF29 00-0EA18	--	3RF29 20-0GA13	--	--	3RF29 20-0HA13
3RF21 20-3A.04	3RF29 00-0EA18	--	3RF29 20-0GA16	3RF29 32-0JA16	3RF29 20-0KA16	3RF29 20-0HA16
3RF21 20-3A.22	--	--	3RF29 20-0GA33	--	3RF29 20-0KA13	3RF29 20-0HA13
3RF21 20-3A.24	--	--	3RF29 20-0GA36	--	3RF29 20-0KA16	3RF29 20-0HA16
Type current = 30 A						
3RF21 30-1A.02	3RF29 00-0EA18	3RF29 20-0FA08	3RF29 50-0GA13	--	--	3RF29 50-0HA13
3RF21 30-1A.04	3RF29 00-0EA18	3RF29 20-0FA08	3RF29 50-0GA16	3RF29 32-0JA16	3RF29 50-0KA16	3RF29 50-0HA16
3RF21 30-1A.06	3RF29 00-0EA18	3RF29 20-0FA08	3RF29 50-0GA16	3RF29 32-0JA16	3RF29 50-0KA16	3RF29 50-0HA16
3RF21 30-1A.22	--	--	3RF29 50-0GA33	--	--	3RF29 50-0HA33
3RF21 30-1A.24	--	--	3RF29 50-0GA36	--	--	3RF29 50-0HA36
3RF21 30-1A.26	--	--	3RF29 50-0GA36	--	--	3RF29 50-0HA36
3RF21 30-1A.42	3RF29 00-0EA18	3RF29 20-0FA08	3RF29 50-0GA13	--	--	3RF29 50-0HA13
3RF21 30-1A.45	3RF29 00-0EA18	3RF29 20-0FA08	3RF29 50-0GA16	3RF29 32-0JA16	3RF29 50-0KA16	3RF29 50-0HA16
3RF21 30-1B.04	3RF29 00-0EA18	3RF29 20-0FA08	3RF29 50-0GA16	3RF29 32-0JA16	3RF29 50-0KA16	3RF29 50-0HA16
Type current = 50 A						
3RF21 50-1A.02	3RF29 00-0EA18	3RF29 20-0FA08	3RF29 50-0GA13	--	--	3RF29 50-0HA13
3RF21 50-1A.04	3RF29 00-0EA18	3RF29 20-0FA08	3RF29 50-0GA16	3RF29 32-0JA16	3RF29 50-0KA16	3RF29 50-0HA16
3RF21 50-1A.06	3RF29 00-0EA18	3RF29 20-0FA08	3RF29 50-0GA16	3RF29 32-0JA16	3RF29 50-0KA16	3RF29 50-0HA16
3RF21 50-1A.22	--	--	3RF29 50-0GA33	--	--	3RF29 50-0HA33
3RF21 50-1A.24	--	--	3RF29 50-0GA36	--	--	3RF29 50-0HA36
3RF21 50-1A.26	--	--	3RF29 50-0GA36	--	--	3RF29 50-0HA36
3RF21 50-1A.45	3RF29 00-0EA18	3RF29 20-0FA08	3RF29 50-0GA16	3RF29 32-0JA16	3RF29 50-0KA16	3RF29 50-0HA16
3RF21 50-1B.04	3RF29 00-0EA18	3RF29 20-0FA08	3RF29 50-0GA16	3RF29 32-0JA16	3RF29 50-0KA16	3RF29 50-0HA16
3RF21 50-1B.06	3RF29 00-0EA18	3RF29 20-0FA08	3RF29 50-0GA16	3RF29 32-0JA16	3RF29 50-0KA16	3RF29 50-0HA16
3RF21 50-1B.22	--	--	3RF29 50-0GA33	--	--	3RF29 50-0HA33
3RF21 50-2A.02	3RF29 00-0EA18	--	--	--	--	--
3RF21 50-2A.04	3RF29 00-0EA18	--	--	--	--	--
3RF21 50-2A.06	3RF29 00-0EA18	--	--	--	--	--
3RF21 50-2A.14	3RF29 00-0EA18	--	--	--	--	--
3RF21 50-2A.22	--	--	--	--	--	--
3RF21 50-2A.24	--	--	--	--	--	--
3RF21 50-2A.26	--	--	--	--	--	--
3RF21 50-3A.02	3RF29 00-0EA18	--	3RF29 50-0GA13	--	--	3RF29 50-0HA13
3RF21 50-3A.04	3RF29 00-0EA18	--	3RF29 50-0GA16	3RF29 32-0JA16	3RF29 50-0KA16	3RF29 50-0HA16
3RF21 50-3A.06	3RF29 00-0EA18	--	3RF29 50-0GA16	3RF29 32-0JA16	3RF29 50-0KA16	3RF29 50-0HA16
3RF21 50-3A.22	--	--	3RF29 50-0GA33	--	--	3RF29 50-0HA33
3RF21 50-3A.24	--	--	3RF29 50-0GA36	--	--	3RF29 50-0HA36
3RF21 50-3A.26	--	--	3RF29 50-0GA36	--	--	3RF29 50-0HA36

¹⁾ The use of power controllers/regulators is also possible on zero-point switching versions for full-wave control mode. The generalized phase control mode is recommended only for the combination with instantaneous switching versions.

Solid-State Switching Devices for Resistive Loads

3RF29 Function Modules

General data

Order No.	Accessories					
	Converters	Load monitoring		Heating current monitoring	Power controllers ¹⁾	Power regulators ¹⁾
		Basic	Extended			
Type current = 70 A						
3RF21 70-1A.02	3RF29 00-0EA18	3RF29 20-0FA08	3RF29 50-0GA13	--	--	3RF29 50-0HA13
3RF21 70-1A.04	3RF29 00-0EA18	3RF29 20-0FA08	3RF29 50-0GA16	3RF29 32-0JA16	3RF29 50-0KA16	3RF29 50-0HA16
3RF21 70-1A.05	3RF29 00-0EA18	3RF29 20-0FA08	3RF29 50-0GA16	3RF29 32-0JA16	3RF29 50-0KA16	3RF29 50-0HA16
3RF21 70-1A.06	3RF29 00-0EA18	3RF29 20-0FA08	3RF29 50-0GA16	3RF29 32-0JA16	3RF29 50-0KA16	3RF29 50-0HA16
3RF21 70-1A.22	--	--	3RF29 50-0GA33	--	--	3RF29 50-0HA33
3RF21 70-1A.24	--	--	3RF29 50-0GA36	--	--	3RF29 50-0HA36
3RF21 70-1A.26	--	--	3RF29 50-0GA36	--	--	3RF29 50-0HA36
3RF21 70-1A.45	3RF29 00-0EA18	3RF29 20-0FA08	3RF29 50-0GA16	3RF29 32-0JA16	3RF29 50-0KA16	3RF29 50-0HA16
3RF21 70-1B.04	3RF29 00-0EA18	3RF29 20-0FA08	3RF29 50-0GA16	3RF29 32-0JA16	3RF29 50-0KA16	3RF29 50-0HA16
3RF21 70-1C.04	3RF29 00-0EA18	3RF29 20-0FA08	3RF29 50-0GA16	3RF29 32-0JA16	3RF29 50-0KA16	3RF29 50-0HA16
Type current = 90 A						
3RF21 90-1A.02	3RF29 00-0EA18	3RF29 20-0FA08	3RF29 50-0GA13	--	--	3RF29 50-0HA13
3RF21 90-1A.04	3RF29 00-0EA18	3RF29 20-0FA08	3RF29 50-0GA16	3RF29 32-0JA16	3RF29 50-0KA16	3RF29 50-0HA16
3RF21 90-1A.06	3RF29 00-0EA18	3RF29 20-0FA08	3RF29 50-0GA16	3RF29 32-0JA16	3RF29 50-0KA16	3RF29 50-0HA16
3RF21 90-1A.22	--	--	3RF29 50-0GA33	--	--	3RF29 50-0HA33
3RF21 90-1A.24	--	--	3RF29 50-0GA36	--	--	3RF29 50-0HA36
3RF21 90-1A.26	--	--	3RF29 50-0GA36	--	--	3RF29 50-0HA36
3RF21 90-1A.45	3RF29 00-0EA18	3RF29 20-0FA08	3RF29 50-0GA16	3RF29 32-0JA16	3RF29 50-0KA16	3RF29 50-0HA16
3RF21 90-1B.04	3RF29 00-0EA18	3RF29 20-0FA08	3RF29 50-0GA16	3RF29 32-0JA16	3RF29 50-0KA16	3RF29 50-0HA16
3RF21 90-2A.02	3RF29 00-0EA18	--	--	--	--	--
3RF21 90-2A.04	3RF29 00-0EA18	--	--	--	--	--
3RF21 90-2A.06	3RF29 00-0EA18	--	--	--	--	--
3RF21 90-2A.22	--	--	--	--	--	--
3RF21 90-2A.24	--	--	--	--	--	--
3RF21 90-2A.26	--	--	--	--	--	--
3RF21 90-3A.02	3RF29 00-0EA18	--	3RF29 90-0GA13	--	--	3RF29 90-0HA13
3RF21 90-3A.04	3RF29 00-0EA18	--	3RF29 90-0GA16	3RF29 32-0JA16	3RF29 90-0KA16	3RF29 90-0HA16
3RF21 90-3A.06	3RF29 00-0EA18	--	3RF29 90-0GA16	3RF29 32-0JA16	3RF29 90-0KA16	3RF29 90-0HA16
3RF21 90-3A.22	--	--	3RF29 90-0GA33	--	--	3RF29 90-0HA33
3RF21 90-3A.24	--	--	3RF29 90-0GA36	--	--	3RF29 90-0HA36
3RF21 90-3A.26	--	--	3RF29 90-0GA36	--	--	3RF29 90-0HA36
3RF21 90-3A.44	3RF29 00-0EA18	--	3RF29 90-0GA16	3RF29 32-0JA16	3RF29 90-0KA16	3RF29 90-0HA16

¹⁾ The use of power controllers/regulators is also possible on zero-point switching versions for full-wave control mode. The generalized phase control mode is recommended only for the combination with instantaneous switching versions.

Recommended assignment of the function modules to the 3RF22 three-phase solid-state relays

Order No.	Accessories					
	Converters	Load monitoring		Heating current monitoring	Power controllers	Power regulators
		Basic	Extended			
Type current up to 55 A						
3RF22 ...1AA..	3RF29 00-0EA18	--	--	--	--	--
3RF22 ...2AA..	3RF29 00-0EA18	--	--	--	--	--
3RF22 ...3AA..	3RF29 00-0EA18	--	--	--	--	--

Recommended assignment of the function modules to the 3RF23 single-phase solid-state contactors

Order No.	Accessories					
	Converters	Load monitoring		Heating current monitoring	Power controllers ¹⁾	Power regulators ¹⁾
		Basic	Extended			
Type current $I_e = 10.5 A$						
3RF23 10-1A.02	3RF29 00-0EA18	3RF29 20-0FA08	3RF29 20-0GA13	3RF29 16-0JA13	3RF29 20-0KA13	3RF29 20-0HA13
3RF23 10-1A.04	3RF29 00-0EA18	3RF29 20-0FA08	3RF29 20-0GA16	3RF29 32-0JA16	3RF29 20-0KA16	3RF29 20-0HA16
3RF23 10-1A.06	3RF29 00-0EA18	3RF29 20-0FA08	3RF29 20-0GA16	3RF29 32-0JA16	3RF29 20-0KA16	3RF29 20-0HA16
3RF23 10-1A.12	3RF29 00-0EA18	--	3RF29 20-0GA13	3RF29 16-0JA13	3RF29 20-0KA13	3RF29 20-0HA13
3RF23 10-1A.14	3RF29 00-0EA18	--	3RF29 20-0GA16	3RF29 32-0JA16	3RF29 20-0KA16	3RF29 20-0HA16
3RF23 10-1A.22	--	--	3RF29 20-0GA33	--	--	3RF29 20-0HA33
3RF23 10-1A.24	--	--	3RF29 20-0GA36	--	--	3RF29 20-0HA36
3RF23 10-1A.26	--	--	3RF29 20-0GA36	--	--	3RF29 20-0HA36
3RF23 10-1A.44	3RF29 00-0EA18	3RF29 20-0FA08	3RF29 20-0GA16	3RF29 32-0JA16	3RF29 20-0KA16	3RF29 20-0HA16
3RF23 10-1A.45	3RF29 00-0EA18	3RF29 20-0FA08	3RF29 20-0GA16	3RF29 32-0JA16	3RF29 20-0KA16	3RF29 20-0HA16

Solid-State Switching Devices for Resistive Loads

3RF29 Function Modules

General data

Order No.	Accessories					
	Converters	Load monitoring		Heating current monitoring	Power controllers ¹⁾	Power regulators ¹⁾
		Basic	Extended			
Type current $I_e = 10.5\text{ A}$						
3RF23 10-1B.02	3RF29 00-0EA18	3RF29 20-0FA08	3RF29 20-0GA13	3RF29 16-0JA13	3RF29 20-0KA13	3RF29 20-0HA13
3RF23 10-1B.04	3RF29 00-0EA18	3RF29 20-0FA08	3RF29 20-0GA16	3RF29 32-0JA16	3RF29 20-0KA16	3RF29 20-0HA16
3RF23 10-1B.06	3RF29 00-0EA18	3RF29 20-0FA08	3RF29 20-0GA16	3RF29 32-0JA16	3RF29 20-0KA16	3RF29 20-0HA16
3RF23 10-1B.22	--	--	3RF29 20-0GA33	--	--	3RF29 20-0HA33
3RF23 10-1B.24	--	--	3RF29 20-0GA36	--	--	3RF29 20-0HA36
3RF23 10-1B.26	--	--	3RF29 20-0GA36	--	--	3RF29 20-0HA36
3RF23 10-2A.02	3RF29 00-0EA18	--	--	--	--	--
3RF23 10-2A.04	3RF29 00-0EA18	--	--	--	--	--
3RF23 10-2A.06	3RF29 00-0EA18	--	--	--	--	--
3RF23 10-2A.22	--	--	--	--	--	--
3RF23 10-2A.24	--	--	--	--	--	--
3RF23 10-2A.26	--	--	--	--	--	--
3RF23 10-3A.02	3RF29 00-0EA18	--	3RF29 20-0GA13	3RF29 16-0JA13	3RF29 20-0KA13	3RF29 20-0HA13
3RF23 10-3A.04	3RF29 00-0EA18	--	3RF29 20-0GA16	3RF29 32-0JA16	3RF29 20-0KA16	3RF29 20-0HA16
3RF23 10-3A.06	3RF29 00-0EA18	--	3RF29 20-0GA16	3RF29 32-0JA16	3RF29 20-0KA16	3RF29 20-0HA16
3RF23 10-3A.22	--	--	3RF29 20-0GA33	--	--	3RF29 20-0HA33
3RF23 10-3A.24	--	--	3RF29 20-0GA36	--	--	3RF29 20-0HA36
3RF23 10-3A.26	--	--	3RF29 20-0GA36	--	--	3RF29 20-0HA36
Type current $I_e = 20\text{ A}$						
3RF23 20-1A.02	3RF29 00-0EA18	3RF29 20-0FA08	3RF29 20-0GA13	--	3RF29 20-0KA13	3RF29 20-0HA13
3RF23 20-1A.04	3RF29 00-0EA18	3RF29 20-0FA08	3RF29 20-0GA16	3RF29 32-0JA16	3RF29 20-0KA16	3RF29 20-0HA16
3RF23 20-1A.06	3RF29 00-0EA18	3RF29 20-0FA08	3RF29 20-0GA16	3RF29 32-0JA16	3RF29 20-0KA16	3RF29 20-0HA16
3RF23 20-1A.14	3RF29 00-0EA18	--	3RF29 20-0GA16	--	3RF29 20-0KA16	3RF29 20-0HA16
3RF23 20-1A.22	--	--	3RF29 20-0GA33	--	--	3RF29 20-0HA33
3RF23 20-1A.24	--	--	3RF29 20-0GA36	--	--	3RF29 20-0HA36
3RF23 20-1A.26	--	--	3RF29 20-0GA36	--	--	3RF29 20-0HA36
3RF23 20-1A.44	3RF29 00-0EA18	3RF29 20-0FA08	3RF29 20-0GA16	3RF29 32-0JA16	3RF29 20-0KA16	3RF29 20-0HA16
3RF23 20-1A.45	3RF29 00-0EA18	3RF29 20-0FA08	3RF29 20-0GA16	3RF29 32-0JA16	3RF29 20-0KA16	3RF29 20-0HA16
3RF23 20-1B.02	3RF29 00-0EA18	3RF29 20-0FA08	3RF29 20-0GA13	--	3RF29 20-0KA13	3RF29 20-0HA13
3RF23 20-1B.04	3RF29 00-0EA18	3RF29 20-0FA08	3RF29 20-0GA16	3RF29 32-0JA16	3RF29 20-0KA16	3RF29 20-0HA16
3RF23 20-1B.06	3RF29 00-0EA18	3RF29 20-0FA08	3RF29 20-0GA16	3RF29 32-0JA16	3RF29 20-0KA16	3RF29 20-0HA16
3RF23 20-1B.22	--	--	3RF29 20-0GA33	--	--	3RF29 20-0HA33
3RF23 20-1B.24	--	--	3RF29 20-0GA36	--	--	3RF29 20-0HA36
3RF23 20-1B.26	--	--	3RF29 20-0GA36	--	--	3RF29 20-0HA36
3RF23 20-1B.44	3RF29 00-0EA18	3RF29 20-0FA08	3RF29 20-0GA16	3RF29 32-0JA16	3RF29 20-0KA16	3RF29 20-0HA16
3RF23 20-1C.02	3RF29 00-0EA18	3RF29 20-0FA08	3RF29 20-0GA13	--	3RF29 20-0KA13	3RF29 20-0HA13
3RF23 20-1C.04	3RF29 00-0EA18	3RF29 20-0FA08	3RF29 20-0GA16	3RF29 32-0JA16	3RF29 20-0KA16	3RF29 20-0HA16
3RF23 20-1C.22	--	--	3RF29 20-0GA33	--	--	3RF29 20-0HA33
3RF23 20-1C.24	--	--	3RF29 20-0GA36	--	--	3RF29 20-0HA36
3RF23 20-1C.44	3RF29 00-0EA18	3RF29 20-0FA08	3RF29 20-0GA16	3RF29 32-0JA16	3RF29 20-0KA16	3RF29 20-0HA16
3RF23 20-1D.02	3RF29 00-0EA18	3RF29 20-0FA08	3RF29 20-0GA13	--	3RF29 20-0KA13	3RF29 20-0HA13
3RF23 20-1D.04	3RF29 00-0EA18	3RF29 20-0FA08	3RF29 20-0GA16	3RF29 32-0JA16	3RF29 20-0KA16	3RF29 20-0HA16
3RF23 20-1D.22	--	--	3RF29 20-0GA33	--	--	3RF29 20-0HA33
3RF23 20-1D.24	--	--	3RF29 20-0GA36	--	--	3RF29 20-0HA36
3RF23 20-1D.44	3RF29 00-0EA18	3RF29 20-0FA08	3RF29 20-0GA16	3RF29 32-0JA16	3RF29 20-0KA16	3RF29 20-0HA16
3RF23 20-2A.02	3RF29 00-0EA18	--	--	--	--	--
3RF23 20-2A.04	3RF29 00-0EA18	--	--	--	--	--
3RF23 20-2A.06	3RF29 00-0EA18	--	--	--	--	--
3RF23 20-2A.22	--	--	--	--	--	--
3RF23 20-2A.24	--	--	--	--	--	--
3RF23 20-2A.26	--	--	--	--	--	--
3RF23 20-2C.02	3RF29 00-0EA18	--	--	--	--	--
3RF23 20-2C.04	3RF29 00-0EA18	--	--	--	--	--
3RF23 20-2C.22	--	--	--	--	--	--
3RF23 20-2C.24	--	--	--	--	--	--
3RF23 20-2D.22	--	--	--	--	--	--
3RF23 20-2D.24	--	--	--	--	--	--
3RF23 20-3A.02	3RF29 00-0EA18	--	3RF29 20-0GA13	--	3RF29 20-0KA13	3RF29 20-0HA13
3RF23 20-3A.04	3RF29 00-0EA18	--	3RF29 20-0GA16	3RF29 32-0JA16	3RF29 20-0KA16	3RF29 20-0HA16
3RF23 20-3A.06	3RF29 00-0EA18	--	3RF29 20-0GA16	3RF29 32-0JA16	3RF29 20-0KA16	3RF29 20-0HA16
3RF23 20-3A.22	--	--	3RF29 20-0GA33	--	--	3RF29 20-0HA33
3RF23 20-3A.24	--	--	3RF29 20-0GA36	--	--	3RF29 20-0HA36
3RF23 20-3A.26	--	--	3RF29 20-0GA36	--	--	3RF29 20-0HA36
3RF23 20-3A.44	3RF29 00-0EA18	--	3RF29 20-0GA16	3RF29 32-0JA16	3RF29 20-0KA16	3RF29 20-0HA16

¹⁾ The use of power controllers/regulators is also possible on zero-point switching versions for full-wave control mode. The generalized phase control mode is recommended only for the combination with instantaneous switching versions.

Solid-State Switching Devices for Resistive Loads

3RF29 Function Modules

General data

Order No.	Accessories		Load monitoring		Heating current monitoring	Power controllers ²⁾	Power regulators ²⁾
	Converters		Basic ¹⁾	Extended			
Type current $I_e = 20$ A							
3RF23 20-3D.02	3RF29 00-0EA18	--		3RF29 20-0GA13	--	3RF29 20-0KA13	3RF29 20-0HA13
3RF23 20-3D.04	3RF29 00-0EA18	--		3RF29 20-0GA16	3RF29 32-0JA16	3RF29 20-0KA16	3RF29 20-0HA16
3RF23 20-3D.22	--	--		3RF29 20-0GA33	--	--	3RF29 20-0HA33
3RF23 20-3D.24	--	--		3RF29 20-0GA36	--	--	3RF29 20-0HA36
Type current $I_e = 30$ A							
3RF23 30-1A.02	3RF29 00-0EA18	--		3RF29 50-0GA13	--	--	3RF29 50-0HA13
3RF23 30-1A.04	3RF29 00-0EA18	--		3RF29 50-0GA16	3RF29 32-0JA16	3RF29 50-0KA16	3RF29 50-0HA16
3RF23 30-1A.06	3RF29 00-0EA18	--		3RF29 50-0GA16	3RF29 32-0JA16	3RF29 50-0KA16	3RF29 50-0HA16
3RF23 30-1A.14	3RF29 00-0EA18	--		3RF29 50-0GA16	3RF29 32-0JA16	3RF29 50-0KA16	3RF29 50-0HA16
3RF23 30-1A.22	--	--		3RF29 50-0GA33	--	--	3RF29 50-0HA33
3RF23 30-1A.24	--	--		3RF29 50-0GA36	--	--	3RF29 50-0HA36
3RF23 30-1A.25	--	--		3RF29 50-0GA36	--	--	3RF29 50-0HA36
3RF23 30-1A.26	--	--		3RF29 50-0GA36	--	--	3RF29 50-0HA36
3RF23 30-1A.44	3RF29 00-0EA18	--		3RF29 50-0GA16	3RF29 32-0JA16	3RF29 50-0KA16	3RF29 50-0HA16
3RF23 30-1A.45	3RF29 00-0EA18	--		3RF29 50-0GA16	3RF29 32-0JA16	3RF29 50-0KA16	3RF29 50-0HA16
3RF23 30-1B.02	3RF29 00-0EA18	--		3RF29 50-0GA13	--	--	3RF29 50-0HA13
3RF23 30-1B.04	3RF29 00-0EA18	--		3RF29 50-0GA16	3RF29 32-0JA16	3RF29 50-0KA16	3RF29 50-0HA16
3RF23 30-1B.06	3RF29 00-0EA18	--		3RF29 50-0GA16	3RF29 32-0JA16	3RF29 50-0KA16	3RF29 50-0HA16
3RF23 30-1B.22	--	--		3RF29 50-0GA33	--	--	3RF29 50-0HA33
3RF23 30-1B.24	--	--		3RF29 50-0GA36	--	--	3RF29 50-0HA36
3RF23 30-1B.26	--	--		3RF29 50-0GA36	--	--	3RF29 50-0HA36
3RF23 30-1B.44	3RF29 00-0EA18	--		3RF29 50-0GA16	3RF29 32-0JA16	3RF29 50-0KA16	3RF29 50-0HA16
3RF23 30-1C.02	3RF29 00-0EA18	--		3RF29 50-0GA13	--	--	3RF29 50-0HA13
3RF23 30-1D.44	3RF29 00-0EA18	--		3RF29 50-0GA16	3RF29 32-0JA16	3RF29 50-0KA16	3RF29 50-0HA16
3RF23 30-3A.02	3RF29 00-0EA18	--		3RF29 50-0GA13	--	--	3RF29 50-0HA13
3RF23 30-3A.04	3RF29 00-0EA18	--		3RF29 50-0GA16	3RF29 32-0JA16	3RF29 50-0KA16	3RF29 50-0HA16
3RF23 30-3A.06	3RF29 00-0EA18	--		3RF29 50-0GA16	3RF29 32-0JA16	3RF29 50-0KA16	3RF29 50-0HA16
3RF23 30-3A.22	--	--		3RF29 50-0GA33	--	--	3RF29 50-0HA33
3RF23 30-3A.24	--	--		3RF29 50-0GA36	--	--	3RF29 50-0HA36
3RF23 30-3A.26	--	--		3RF29 50-0GA36	--	--	3RF29 50-0HA36
3RF23 30-3A.44	3RF29 00-0EA18	--		3RF29 50-0GA16	3RF29 32-0JA16	3RF29 50-0KA16	3RF29 50-0HA16
Type current $I_e = 40$ A							
3RF23 40-1A.02	3RF29 00-0EA18	--		3RF29 50-0GA13	--	--	3RF29 50-0HA13
3RF23 40-1A.04	3RF29 00-0EA18	--		3RF29 50-0GA16	--	3RF29 50-0KA16	3RF29 50-0HA16
3RF23 40-1A.06	3RF29 00-0EA18	--		3RF29 50-0GA16	--	3RF29 50-0KA16	3RF29 50-0HA16
3RF23 40-1A.14	3RF29 00-0EA18	--		3RF29 50-0GA16	--	3RF29 50-0KA16	3RF29 50-0HA16
3RF23 40-1A.22	--	--		3RF29 50-0GA33	--	--	3RF29 50-0HA33
3RF23 40-1A.24	--	--		3RF29 50-0GA36	--	--	3RF29 50-0HA36
3RF23 40-1A.26	--	--		3RF29 50-0GA36	--	--	3RF29 50-0HA36
3RF23 40-1A.45	3RF29 00-0EA18	--		3RF29 50-0GA16	--	3RF29 50-0KA16	3RF29 50-0HA16
3RF23 40-1B.02	3RF29 00-0EA18	--		3RF29 50-0GA13	--	--	3RF29 50-0HA13
3RF23 40-1B.04	3RF29 00-0EA18	--		3RF29 50-0GA13	--	3RF29 50-0KA16	3RF29 50-0HA16
3RF23 40-1B.06	3RF29 00-0EA18	--		3RF29 50-0GA13	--	3RF29 50-0KA16	3RF29 50-0HA16
3RF23 40-1B.22	--	--		3RF29 50-0GA33	--	--	3RF29 50-0HA33
3RF23 40-1B.24	--	--		3RF29 50-0GA36	--	--	3RF29 50-0HA36
3RF23 40-1B.26	--	--		3RF29 50-0GA36	--	--	3RF29 50-0HA36
3RF23 40-3A.02	3RF29 00-0EA18	--		3RF29 50-0GA13	--	--	3RF29 50-0HA13
3RF23 40-3A.04	3RF29 00-0EA18	--		3RF29 50-0GA16	--	3RF29 50-0KA16	3RF29 50-0HA16
3RF23 40-3A.06	3RF29 00-0EA18	--		3RF29 50-0GA16	--	3RF29 50-0KA16	3RF29 50-0HA16
3RF23 40-3A.22	--	--		3RF29 50-0GA33	--	--	3RF29 50-0HA33
3RF23 40-3A.24	--	--		3RF29 50-0GA36	--	--	3RF29 50-0HA36
3RF23 40-3A.26	--	--		3RF29 50-0GA36	--	--	3RF29 50-0HA36
3RF23 40-3A.45	3RF29 00-0EA18	--		3RF29 50-0GA16	--	3RF29 50-0KA16	3RF29 50-0HA16
Type current $I_e = 50$ A							
3RF23 50-1A.02	3RF29 00-0EA18	--		3RF29 50-0GA13	--	--	3RF29 50-0HA13
3RF23 50-1A.04	3RF29 00-0EA18	--		3RF29 50-0GA16	--	3RF29 50-0KA16	3RF29 50-0HA16
3RF23 50-1A.06	3RF29 00-0EA18	--		3RF29 50-0GA16	--	3RF29 50-0KA16	3RF29 50-0HA16
3RF23 50-1A.14	3RF29 00-0EA18	--		3RF29 50-0GA16	--	3RF29 50-0KA16	3RF29 50-0HA16
3RF23 50-1A.22	--	--		3RF29 50-0GA33	--	--	3RF29 50-0HA33
3RF23 50-1A.24	--	--		3RF29 50-0GA36	--	--	3RF29 50-0HA36
3RF23 50-1A.26	--	--		3RF29 50-0GA36	--	--	3RF29 50-0HA36
3RF23 50-1A.45	3RF29 00-0EA18	--		3RF29 50-0GA16	--	3RF29 50-0KA16	3RF29 50-0HA16

¹⁾ The technical data should be taken into account when selecting the function modules. Other combinations are possible if the solid-state relay and contactor are not fully utilized; e.g. load monitoring for 20 A can be used with a solid-state contactor for 30 A, if the load current during operation is not greater than 120 A.

²⁾ The use of power controllers/regulators is also possible on zero-point switching versions for full-wave control mode. The generalized phase control mode is recommended only for the combination with instantaneous switching versions.

Solid-State Switching Devices for Resistive Loads

3RF29 Function Modules

General data

Order No.	Accessories					Power controllers ¹⁾	Power regulators ¹⁾
	Converters	Load monitoring		Heating current monitoring			
		Basic	Extended				
Type current $I_e = 50$ A							
3RF23 50-1B.02	3RF29 00-0EA18	--	3RF29 50-0GA13	--	--	3RF29 50-0HA13	
3RF23 50-1B.04	3RF29 00-0EA18	--	3RF29 50-0GA16	--	3RF29 50-0KA16	3RF29 50-0HA16	
3RF23 50-1B.06	3RF29 00-0EA18	--	3RF29 50-0GA16	--	3RF29 50-0KA16	3RF29 50-0HA16	
3RF23 50-1B.22	--	--	3RF29 50-0GA33	--	--	3RF29 50-0HA33	
3RF23 50-1B.24	--	--	3RF29 50-0GA36	--	--	3RF29 50-0HA36	
3RF23 50-1B.26	--	--	3RF29 50-0GA36	--	--	3RF29 50-0HA36	
3RF23 50-1B.44	3RF29 00-0EA18	--	3RF29 50-0GA16	--	3RF29 50-0KA16	3RF29 50-0HA16	
3RF23 50-3A.02	3RF29 00-0EA18	--	3RF29 50-0GA13	--	--	3RF29 50-0HA13	
3RF23 50-3A.04	3RF29 00-0EA18	--	3RF29 50-0GA16	--	3RF29 50-0KA16	3RF29 50-0HA16	
3RF23 50-3A.06	3RF29 00-0EA18	--	3RF29 50-0GA16	--	3RF29 50-0KA16	3RF29 50-0HA16	
3RF23 50-3A.22	--	--	3RF29 50-0GA33	--	--	3RF29 50-0HA33	
3RF23 50-3A.24	--	--	3RF29 50-0GA36	--	--	3RF29 50-0HA36	
3RF23 50-3A.26	--	--	3RF29 50-0GA36	--	--	3RF29 50-0HA36	
3RF23 50-3A.44	3RF29 00-0EA18	--	3RF29 50-0GA16	--	3RF29 50-0KA16	3RF29 50-0HA16	
Type current $I_e = 70$ A							
3RF23 70-1B.02	3RF29 00-0EA18	--	3RF29 50-0GA13	--	--	3RF29 50-0HA13	
3RF23 70-1B.04	3RF29 00-0EA18	--	3RF29 50-0GA16	--	3RF29 50-0KA16	3RF29 50-0HA16	
3RF23 70-1B.06	3RF29 00-0EA18	--	3RF29 50-0GA16	--	3RF29 50-0KA16	3RF29 50-0HA16	
3RF23 70-1B.22	--	--	3RF29 50-0GA33	--	--	3RF29 50-0HA33	
3RF23 70-1B.24	--	--	3RF29 50-0GA36	--	--	3RF29 50-0HA36	
3RF23 70-1B.26	--	--	3RF29 50-0GA36	--	--	3RF29 50-0HA36	
3RF23 70-3A.02	3RF29 00-0EA18	--	3RF29 90-0GA13	--	--	3RF29 90-0HA13	
3RF23 70-3A.04	3RF29 00-0EA18	--	3RF29 90-0GA16	--	3RF29 90-0KA16	3RF29 90-0HA16	
3RF23 70-3A.06	3RF29 00-0EA18	--	3RF29 90-0GA16	--	3RF29 90-0KA16	3RF29 90-0HA16	
3RF23 70-3A.22	--	--	3RF29 90-0GA33	--	--	3RF29 90-0HA33	
3RF23 70-3A.24	--	--	3RF29 90-0GA36	--	--	3RF29 90-0HA36	
3RF23 70-3A.26	--	--	3RF29 90-0GA36	--	--	3RF29 90-0HA36	
3RF23 70-3A.45	3RF29 00-0EA18	--	3RF29 90-0GA16	--	3RF29 90-0KA16	3RF29 90-0HA16	
3RF23 70-3B.02	3RF29 00-0EA18	--	3RF29 90-0GA13	--	--	3RF29 90-0HA13	
3RF23 70-3B.04	3RF29 00-0EA18	--	3RF29 90-0GA16	--	3RF29 90-0KA16	3RF29 90-0HA16	
3RF23 70-3B.06	3RF29 00-0EA18	--	3RF29 90-0GA16	--	3RF29 90-0KA16	3RF29 90-0HA16	
3RF23 70-3B.22	--	--	3RF29 90-0GA33	--	--	3RF29 90-0HA33	
3RF23 70-3B.24	--	--	3RF29 90-0GA36	--	--	3RF29 90-0HA36	
3RF23 70-3B.26	--	--	3RF29 90-0GA36	--	--	3RF29 90-0HA36	
Type current $I_e = 90$ A							
3RF23 90-1B.02	3RF29 00-0EA18	--	3RF29 50-0GA13	--	--	3RF29 50-0HA13	
3RF23 90-1B.04	3RF29 00-0EA18	--	3RF29 50-0GA16	--	3RF29 50-0KA16	3RF29 50-0HA16	
3RF23 90-1B.06	3RF29 00-0EA18	--	3RF29 50-0GA16	--	3RF29 50-0KA16	3RF29 50-0HA16	
3RF23 90-1B.22	--	--	3RF29 50-0GA33	--	--	3RF29 50-0HA33	
3RF23 90-1B.24	--	--	3RF29 50-0GA36	--	--	3RF29 50-0HA36	
3RF23 90-1B.26	--	--	3RF29 50-0GA36	--	--	3RF29 50-0HA36	
3RF23 90-3A.02	3RF29 00-0EA18	--	3RF29 90-0GA13	--	--	3RF29 90-0HA13	
3RF23 90-3A.04	3RF29 00-0EA18	--	3RF29 90-0GA16	--	3RF29 90-0KA16	3RF29 90-0HA16	
3RF23 90-3A.06	3RF29 00-0EA18	--	3RF29 90-0GA16	--	3RF29 90-0KA16	3RF29 90-0HA16	
3RF23 90-3A.22	--	--	3RF29 90-0GA33	--	--	3RF29 90-0HA33	
3RF23 90-3A.24	--	--	3RF29 90-0GA36	--	--	3RF29 90-0HA36	
3RF23 90-3A.26	--	--	3RF29 90-0GA36	--	--	3RF29 90-0HA36	
3RF23 90-3A.45	3RF29 00-0EA18	--	3RF29 90-0GA16	--	3RF29 90-0KA16	3RF29 90-0HA16	
3RF23 90-3B.02	3RF29 00-0EA18	--	3RF29 90-0GA13	--	--	3RF29 90-0HA13	
3RF23 90-3B.04	3RF29 00-0EA18	--	3RF29 90-0GA16	--	3RF29 90-0KA16	3RF29 90-0HA16	
3RF23 90-3B.06	3RF29 00-0EA18	--	3RF29 90-0GA16	--	3RF29 90-0KA16	3RF29 90-0HA16	
3RF23 90-3B.22	--	--	3RF29 90-0GA33	--	--	3RF29 90-0HA33	
3RF23 90-3B.24	--	--	3RF29 90-0GA36	--	--	3RF29 90-0HA36	
3RF23 90-3B.26	--	--	3RF29 90-0GA36	--	--	3RF29 90-0HA36	

¹⁾ The use of power controllers/regulators is also possible on zero-point switching versions for full-wave control mode. The generalized phase control mode is recommended only for the combination with instantaneous switching versions.

Recommended assignment of the function modules to the 3RF24 three-phase solid-state contactors

Order No.	Accessories					Power controllers	Power regulators
	Converters	Load monitoring		Heating current monitoring			
		Basic	Extended				
Type current up to 50 A							
3RF24 ...1..4.	3RF29 00-0EA18	--	--	--	--	--	
3RF24 ...2..4.	--	--	--	--	--	--	
3RF24 ...3..4.	3RF29 00-0EA18	--	--	--	--	--	
3RF24 ...4..5.	--	--	--	--	--	--	

Solid-State Switching Devices for Resistive Loads

3RF29 Function Modules

General data

Technical specifications

Type		3RF29 ..-0EA..	3RF29 ..-0FA..	3RF29 ..-0GA..	3RF29 ..-0HA..	3RF29 ..-0JA..	3RF29 ..-0KA..
Dimensions (W x H x D)	mm	22.5 x 84 x 38	22.5 x 102 x 39	45 x 112 x 44	45 x 112 x 44	45 x 112 x 44	45 x 112 x 44
General data							
Ambient temperature							
• During operation, derating from 40 °C	°C	-25 ... +60					
• During storage	°C	-55 ... +80					
Installation altitude	m	0 ... 1000; derating from 1000					
Shock resistance acc. to IEC 60068-2-27	g/ms	15/11					
Vibration resistance acc. to IEC 60068-2-6	g	2					
Degree of protection		IP20					
Electromagnetic compatibility (EMC)							
• Emitted interference							
- Conducted interference voltage acc. to IEC 60947-4-3		Class A for industrial applications ¹⁾					
- Emitted, high-frequency interference voltage acc. to IEC 60947-4-3		Class B for residential, business and commercial applications					
• Interference immunity							
- Electrostatic discharge acc. to IEC 61000-4-2 (corresponds to degree of severity 3)	kV	Contact discharge 4; air discharge 8; behavior criterion 2					
- Induced RF fields acc. to IEC 61000-4-6	MHz	0.15 ... 80; 140 dB μ V; behavior criterion 1					
- Burst acc. to IEC 61000-4-4		2 kV/5.0 kHz; behavior criterion 2					
- Surge acc. to IEC 61000-4-5	kV	Conductor - ground 2; conductor - conductor 1; behavior criterion 2					
Connection, auxiliary/control contacts, screw terminals							
• Conductor cross-section	mm ²	1 x (0.5 ... 2.5), 2 x (0.5 ... 1.0), 1 x (AWG 20 ... 12)					
• Stripped length	mm	7					
• Terminal screw		M3					
• Tightening torque	Nm lb.in	0.5 ... 0.6 4.5 ... 5.3					
Transformer, feed-through opening							
• Diameter	mm	--	7		17		

¹⁾ Note limitations for power controller function modules. These modules were built as Class A devices. The use of these devices in residential areas could result in lead in radio interference. In this case these may be required to introduce additional interference suppression measures.

Type		3RF29 ..-0EA18	3RF29 ..-0FA08	3RF29 ..-0GA.3	3RF29 ..-0GA.6
Main circuit					
Rated operational voltage U_e	V AC	-- ¹⁾		110 ... 230	400 ... 600
• Operating range	V AC	--		93.5 ... 253	340 ... 660
• Rated frequency	Hz	--		50/60	
Rated insulation voltage U_i	V	--		600	
Voltage measuring					
• Measuring range	V	--		93.5 ... 253	340 ... 660
Mains voltage, fluctuation compensation	%	--		20	

¹⁾ Versions are independent of the main circuit.

Type		3RF29 ..-0HA.3 3RF29 ..-0KA.3	3RF29 ..-0HA.6 3RF29 ..-0KA.6	3RF29 ..-0JA.3	3RF29 ..-0JA.6
Main circuit					
Rated operational voltage U_e	V AC	110 ... 230	400 ... 600	110 ... 230	400 ... 600
• Operating range	V AC	93.5 ... 253	340 ... 660	93.5 ... 253	340 ... 660
• Rated frequency	Hz	50/60			
Rated insulation voltage U_i	V	600			
Voltage measuring					
• Measuring range	V	93.5 ... 253	340 ... 660	93.5 ... 253	340 ... 660
Mains voltage, fluctuation compensation	%	20			

Solid-State Switching Devices for Resistive Loads

3RF29 Function Modules

General data



Type		3RF29 ...0.	3RF29 ...1.	3RF29 ...3.
Control circuit				
Method of operation		DC operation	AC/DC operation	AC operation
Rated control supply voltage U_s	V	24	24	110
Rated control current	mA	15	15	15
Rated frequency of the control supply voltage	Hz	--	50/60	50/60
Actuating voltage, max.	V	30	30	121
Rated control current At maximum voltage	mA	15	15	15
Response voltage	V	15	15	90
• For operating current	mA	2	2	2
Drop-out voltage	V	5	5	15

Type		3RF29 06-0FA08	3RF29 20-0FA08	3RF29 20-0GA..	3RF29 50-0GA..	3RF29 90-0GA..
Current measurement						
Rated operational current I_e	A	6	20	20	50	90
Current measurement						
• Teach range	A	0.25 ... 6	0.65 ... 20	0.56 ... 20	1.62 ... 50	2.93 ... 90
• Measuring range	A	0 ... 6.6	0 ... 22	0 ... 22	0 ... 55	0 ... 99
• Minimum partial load current	A	0.25	0.65	0.65	1.6	2.9
Number of partial loads		1 ... 6	1 ... 6	1 ... 12		

Type		3RF29 20-0HA..	3RF29 50-0HA..	3RF29 90-0HA..	3RF29 16-0JA..	3RF29 32-0JA..
Current measurement						
Rated operational current I_e	A	20	50	90	16	32
Current measurement						
• Teach range	A	4 ... 20	10 ... 50	18 ... 90	0.42 ... 16	0.8 ... 32
• Measuring range	A	0 ... 22	0 ... 55	4 ... 99	0 ... 16	0 ... 32
• Minimum partial load current	A	--	--	--	0.42	0.8
Number of partial loads		--	--	--	1 ... 6	--

Type		3RF29 04-0KA..	3RF29 20-0KA..	3RF29 50-0KA..	3RF29 90-0KA..
Current measurement					
Rated operational current I_e	A	4	20	50	90
Current measurement					
• Teach range	A	0.15 ... 4	0.65 ... 20	1.6 ... 50	2.9 ... 90
• Measuring range	A	0 ... 4	0 ... 22	0 ... 55	0 ... 99
• Minimum partial load current	A	--	0.65	1.6	2.9
Number of partial loads		--	1 ... 6	--	--

Circuit diagrams

Converters

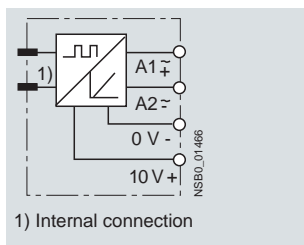

Basic load monitoring

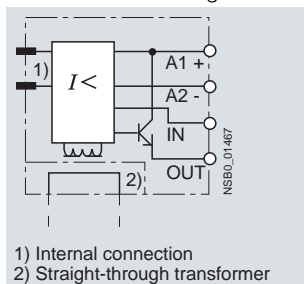

Extended load monitoring

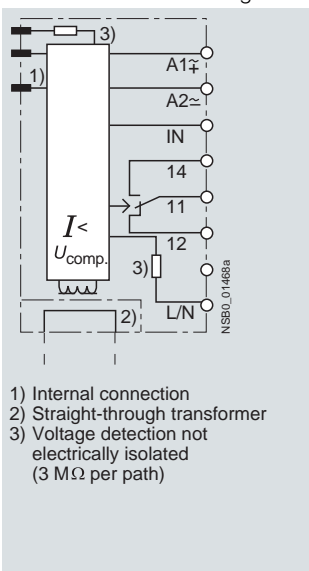

Heating current monitoring

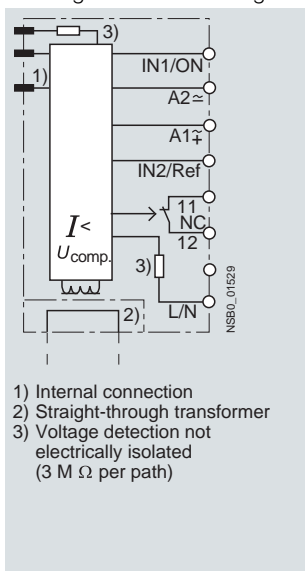

Power controller and regulator

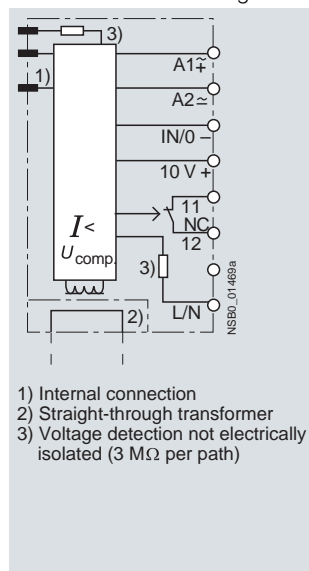

Solid-State Switching Devices for Resistive Loads

3RF29 Function Modules

SIRIUS converters for 3RF2

Overview

Converters for 3RF2 solid-state switching devices

These modules are used to convert analog control signals, such as those output from many temperature controllers for example, into a pulse-width-modulated digital signal. The connected solid-state contactors and relays can therefore regulate the output of a load as a percentage.

Application

This function module is used for conversion from an analog input signal to an on/off ratio. The module can only be used in conjunction with 3RF21 and 3RF23 single-phase solid-state switching devices or 3RF22 and 3RF24 three-phase devices. It can be used on versions with 24 V DC and 24 V AC/DC control supply voltage.

Selection and ordering data

Rated operational current I_e	Rated operational voltage U_e	DT	Screw terminals 	PU (UNIT, SET, M)	PS*	PG
A	V		Order No.	Price per PU		

Converters

Rated control supply voltage 24 V AC/DC						
--	--	A	3RF29 00-0EA18	1	1 unit	101



3RF29 00-0EA18

4

Solid-State Switching Devices for Resistive Loads

3RF29 Function Modules

SIRIUS load monitoring for 3RF2

Overview

Load monitoring for 3RF2 single-phase solid-state switching devices

Many faults can be quickly detected by monitoring a load circuit connected to the solid-state switching device, as made possible with this module. Examples include the failure of load elements (up to 6 in the basic version or up to 12 in the extended version), alloyed power semiconductors, a lack of voltage or a break in a load circuit. A fault is indicated by one or more LEDs and reported to the controller by way of a PLC-compatible output.

The principle of operation is based on permanent monitoring of the current intensity. This figure is continuously compared with the reference value stored once during start-up by the simple press of a button. In order to detect the failure of one of several loads, the current difference must be 1/6 (in the basic version) or 1/12 (in the extended version) of the reference value. In the event of a fault, an output is actuated and one or more LEDs indicate the fault.

Application

The device is used for monitoring one or more loads (partial loads). The function module can only be used in conjunction with a 3RF21 solid-state relay or a 3RF23 solid-state contactor. The devices with spring-type connections in the load circuit are not suitable.

Selection and ordering data

Rated operational current I_e	Rated operational voltage U_e	DT	Screw terminals	PU (UNIT, SET, M)	PS*	PG
A	V		Order No.	Price per PU		

Basic load monitoring



3RF29

Rated control supply voltage 24 V DC		DT	Order No.	Price per PU	PU (UNIT, SET, M)	PS*	PG
6	--	A	3RF29 06-0FA08		1	1 unit	101
20	--	A	3RF29 20-0FA08		1	1 unit	101
• With mounted 3RF29 00-0RA88 cover							
6	--	A	3RF29 06-0FA08-0KH0		1	1 unit	101
20	--	A	3RF29 20-0FA08-0KH0		1	1 unit	101

Extended load monitoring



3RF29

Rated control supply voltage 24 V AC/DC		DT	Order No.	Price per PU	PU (UNIT, SET, M)	PS*	PG
20	110 ... 230	A	3RF29 20-0GA13		1	1 unit	101
20	400 ... 600	A	3RF29 20-0GA16		1	1 unit	101
50	110 ... 230	A	3RF29 50-0GA13		1	1 unit	101
50	400 ... 600	A	3RF29 50-0GA16		1	1 unit	101
90	110 ... 230	A	3RF29 90-0GA13		1	1 unit	101
90	400 ... 600	A	3RF29 90-0GA16		1	1 unit	101
Rated control supply voltage 110 V AC		DT	Order No.	Price per PU	PU (UNIT, SET, M)	PS*	PG
20	110 ... 230	A	3RF29 20-0GA33		1	1 unit	101
20	400 ... 600	A	3RF29 20-0GA36		1	1 unit	101
50	110 ... 230	A	3RF29 50-0GA33		1	1 unit	101
50	400 ... 600	A	3RF29 50-0GA36		1	1 unit	101
90	110 ... 230	A	3RF29 90-0GA33		1	1 unit	101
90	400 ... 600	A	3RF29 90-0GA36		1	1 unit	101

Version	DT	Order No.	Price per PU	PU (UNIT, SET, M)	PS*	PG
---------	----	-----------	--------------	-------------------	-----	----

Optional accessories



3RF29 00-0RA88

Sealable covers for function modules (not for converters)	B	3RF29 00-0RA88		1	10 units	101
--	---	-----------------------	--	---	----------	-----

Solid-State Switching Devices for Resistive Loads

3RF29 Function Modules

SIRIUS heating current monitoring for 3RF2

Overview

Heating current monitoring for 3RF2 single-phase solid-state switching devices

Many faults can be quickly detected by monitoring a load circuit connected to the solid-state switching device, as made possible with this module. Examples include the failure of up to 6 load elements, alloyed power semiconductors, a lack of voltage or a break in a load circuit. A fault is indicated by LEDs and reported to the controller by way of a relay output (NC contact).

The principle of operation is based on permanent monitoring of the current intensity. This figure is continuously compared with the reference value stored once during start-up. In order to detect the failure of one of several loads, the current difference must be 1/6 of the reference value. In the event of a fault, an output is actuated and the LEDs indicate the fault.

The heating current monitoring has a teach input and therefore differs from the load monitoring. This remote teaching function enables simple adjustment to changing loads without manual intervention.

Special versions: deviations from the standard version

3RF29 ...-0JA1.-1KK0

If the current is below 50% of the lower teach current during the teach routine, the device will go into "Standby" mode; the LOAD LED will flicker. The device thus detects a non-connected load, e.g. channels not required for tool heaters, and does not signal a fault. This mode can be reset by re-teaching.

Application

The device is used for monitoring one or more loads (partial loads). The function module can only be used in conjunction with a 3RF21 solid-state relay or a 3RF23 solid-state contactor. The devices with spring-type connections in the load circuit are not suitable.

Selection and ordering data

Rated operational current I_e	Rated operational voltage U_e	DT	Screw terminals	⊕	PU (UNIT, SET, M)	PS*	PG
A	V		Order No.		Price per PU		

Heating current monitoring¹⁾



3RF29

Rated control supply voltage 24 V AC/DC

16	110 ... 230	A	3RF29 16-0JA13		1	1 unit	101
16	110 ... 230	A	3RF29 16-0JA13-1KK0		1	1 unit	101
16	400 ... 600	A	3RF29 16-0JA16-1KK0		1	1 unit	101
32	110 ... 230	A	3RF29 32-0JA13-1KK0		1	1 unit	101
32	400 ... 600	A	3RF29 32-0JA16		1	1 unit	101
32	400 ... 600	A	3RF29 32-0JA16-1KK0		1	1 unit	101

¹⁾ Supplied without control connector. The control connector can be purchased from Phoenix Contact by quoting Order No. 1982 790 (2.5 HC/6-ST-5.08).

Version	DT	Order No.	Price per PU	PU (UNIT, SET, M)	PS*	PG
---------	----	-----------	-----------------	-------------------------	-----	----

Optional accessories



3RF29 00-0RA88

**Sealable covers
for function modules** (not for converters)

B	3RF29 00-0RA88		1	10 units	101
---	-----------------------	--	---	----------	-----

Solid-State Switching Devices for Resistive Loads

3RF29 Function Modules

SIRIUS power controllers for 3RF2

Overview

Power controllers for 3RF2 single-phase solid-state switching devices

The power controller is a function module for the autonomous power control of complex heating systems and inductive loads.

The following functions have been integrated:

- **Power controller** for adjusting the power of the connected load. Here, the setpoint value is set with a rotary knob on the module as a percentage with reference to the 100 % power stored as a setpoint value.
- **Inrush current limitation**: With the aid of an adjustable voltage ramp, the inrush current is limited by means of phase control. This is useful above all with loads such as lamps or infrared lamps which have an inrush transient current.
- **Load circuit monitoring** for detecting load failure, partial load faults, alloyed power semiconductors, lack of voltage or a break in the load circuit.

Note:

With the phase control operating mode, a partial load fault is detected by cyclic "scanning" of the load; the exact mode of operation is described in the data sheets!

Special versions: deviations from the standard version

3RF29 04-0KA13-0KCO

During the teaching process the connected solid-state relay or contactor is not activated; i.e. no current flow takes place. No current reference value is stored. No part-load monitoring!

3RF29 ..-0KA1.-0KTO

No part-load monitoring!

Application

The power controller can be used for:

- Complex heating systems
- Inductive loads
- Loads with temperature-dependent resistor
- Loads with ageing after long-time service
- Simple indirect control of temperature

The power controller can be used on the instantaneously switching 3RF21 and 3RF23 solid-state switching devices (single-phase). If only the full-wave operating mode is used, the power controller can also be used on the "zero-point switching" solid-state relays and contactors.

Power control

The power controller adjusts the power in the connected load by means of a solid-state switching device depending on the setpoint selection. It does not compensate for changes in the mains voltage or load resistance. The setpoint value can be predefined externally as a 0 to 10 V signal or internally by means of a potentiometer. Depending on the setting of the potentiometer (t_R), the control is carried out according to the principle of full-wave control or generalized phase control.

Full-wave control

In this operating mode the output is adjusted to the required setpoint value changing the on-to-off period. The period duration is predefined at one second.

Generalized phase control

In this operating mode the output is adjusted to the required setpoint value by changing the current flow angle. In order to observe the limit values of the conducted interference voltage for industrial networks, the load circuit must include a reactor with a rating of at least 200 μ H.

Selection and ordering data

Rated operational current I_e	Rated operational voltage U_e	DT	Screw terminals	⊕	PU (UNIT, SET, M)	PS*	PG
A	V		Order No.		Price per PU		
Power controllers							
Rated control supply voltage 24 V AC/DC							
4	110 ... 230	A	3RF29 04-0KA13-0KCO		1	1 unit	101
4		A	3RF29 04-0KA13-0KTO		1	1 unit	101
20		A	3RF29 20-0KA13		1	1 unit	101
50		A	3RF29 50-0KA13		1	1 unit	101
90		A	3RF29 90-0KA13		1	1 unit	101
20	400 ... 600	A	3RF29 20-0KA16		1	1 unit	101
50		A	3RF29 50-0KA16		1	1 unit	101
50		A	3RF29 50-0KA16-0KTO		1	1 unit	101
90		A	3RF29 90-0KA16		1	1 unit	101
Optional accessories							
Sealable covers for function modules (not for converters)		B	3RF29 00-0RA88		1	10 units	101



3RF29



3RF29 00-0RA88

Solid-State Switching Devices for Resistive Loads

3RF29 Function Modules

SIRIUS power regulators for 3RF2

Overview

Power regulators for 3RF2 single-phase solid-state switching devices

The power regulator is a function module for the autonomous power control of complex heating systems.

The following functions have been integrated:

- **Power controller with proportional-action control** for adjusting the power of the connected load. Here, the setpoint value is set with a rotary knob on the module as a percentage with reference to the 100 % power stored as a setpoint value. Changes in the mains voltage or in the load resistance are compensated in this case.
- **Inrush current limitation:** With the aid of an adjustable voltage ramp, the inrush current is limited by means of phase control. This is useful above all with loads such as lamps which have an inrush transient current.
- **Load circuit monitoring** for detecting load failure, alloyed power semiconductors, lack of voltage or a break in the load circuit. Part-load monitoring is not possible. Load fluctuations are compensated.

Application

The power regulator can be used for:

- Complex heating systems
- Heating elements with temperature-dependent resistor
- Heating elements with ageing after long-time service
- Simple indirect control of temperature

The power regulator can be used on the instantaneously switching 3RF21 and 3RF23 solid-state switching devices (single-phase). If only the full-wave operating mode is used, the power regulator can also be used on the zero-point switching solid-state relays and contactors.

Power control

The power regulator adjusts the power in the connected load by means of a solid-state switching device depending on the taught power and the selected setpoint. Changes in the mains voltage or in the load resistance are thus compensated by the power regulator. The setpoint value can be predefined externally as a 0 to 10 V signal or internally by means of a potentiometer. Depending on the setting of the potentiometer (t_{P}), the adjustment is carried out according to the principle of full-wave control or generalized phase control.

Full-wave control

In this operating mode the output is adjusted to the required setpoint value changing the on-to-off period. The period duration is predefined at one second.

Generalized phase control

In this operating mode the output is adjusted to the required setpoint value by changing the current flow angle. In order to observe the limit values of the conducted interference voltage for industrial networks, the load circuit must include a reactor with a rating of at least 200 μH .

Selection and ordering data

Rated operational current I_e	Rated operational voltage U_e	DT	Screw terminals	⊕	PU (UNIT, SET, M)	PS*	PG
A	V		Order No.		Price per PU		
Power regulators							
Rated control supply voltage 24 V AC/DC							
20	110 ... 230	A	3RF29 20-0HA13		1	1 unit	101
20	400 ... 600	A	3RF29 20-0HA16		1	1 unit	101
50	110 ... 230	A	3RF29 50-0HA13		1	1 unit	101
50	400 ... 600	A	3RF29 50-0HA16		1	1 unit	101
90	110 ... 230	A	3RF29 90-0HA13		1	1 unit	101
90	400 ... 600	A	3RF29 90-0HA16		1	1 unit	101
Rated control supply voltage 110 V AC							
20	110 ... 230	A	3RF29 20-0HA33		1	1 unit	101
20	400 ... 600	A	3RF29 20-0HA36		1	1 unit	101
50	110 ... 230	A	3RF29 50-0HA33		1	1 unit	101
50	400 ... 600	A	3RF29 50-0HA36		1	1 unit	101
90	110 ... 230	A	3RF29 90-0HA33		1	1 unit	101
90	400 ... 600	A	3RF29 90-0HA36		1	1 unit	101



3RF29

Version	DT	Order No.	Price per PU	PU (UNIT, SET, M)	PS*	PG
---------	----	-----------	-----------------	-------------------------	-----	----

Optional accessories



3RF29 00-0RA88

Sealable covers for function modules (not for converters)	B	3RF29 00-0RA88		1	10 units	101
--	---	-----------------------	--	---	----------	-----