

Gear Lever Handles

24350.0062



Product Description

Material

Gear lever handle

- Steel, zinc-plated by galvanization, passivated

Ball knob

- Thermosetting plastic PF 31, black, DIN 319

Cylindrical handle

- Thermosetting plastic PF 31, black

Drawing

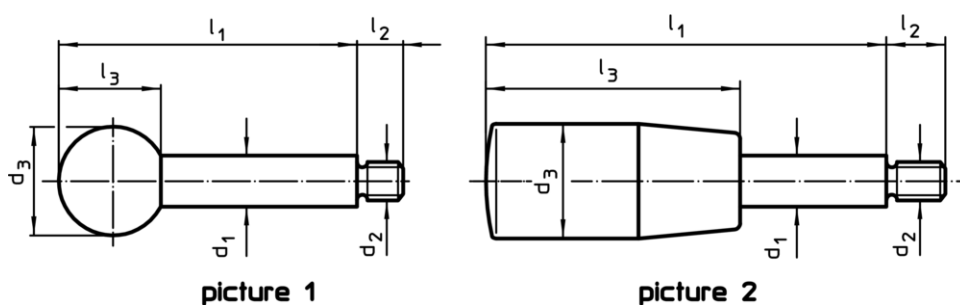

Order information

Dimensions						max. [°C]	[g]	Art. No.
d ₁	l ₁	d ₂ [mm]	d ₃	l ₂	l ₃			
with spherical knob – picture 1, steel								
16	200	M14	40	18	37	110	326	24350.0062

Application example

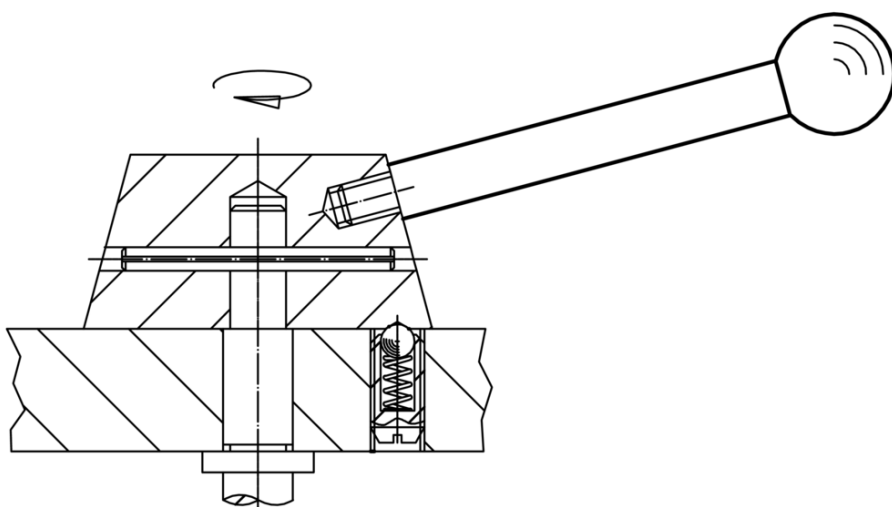

Compliance

RoHS compliant

Contains lead - compliant according to exceptions 6a / 6b / 6c

Contains SVHC substances >0,1% w/w

Contains lead - SVHC list [REACH] as of 10.06.2022

Contains Proposition 65 substances



Lead can cause cancer and reproductive harm from exposure
<https://www.P65Warnings.ca.gov/>

Free from Conflict Minerals

This product does not contain any substances designated as "conflict minerals" such as tantalum, tin, gold or tungsten from the Democratic Republic of Congo or adjacent countries.