



CONTACT 2000

Inhaltsverzeichnis

List of contents

Sommaire

Einleitung / Introduction / Introduction	4
---	---

Technisches Vorwort / Technical considerations / Préambule technique	10
---	----

Rechtecksteckverbinder / Rectangular connector / Connecteur rectangulaire

Einsätze / Inserts / Inserts

1.1	EPIC H-A	47
1.2	EPIC STA	53
1.3	EPIC H-BE	57
1.4	EPIC H-BS	67
1.5	EPIC H-BVE	71
1.6	EPIC H-D	75
1.7	EPIC H-DD	81
1.8	EPIC MC	85
1.9	EPIC TB	95

Kontakte und Werkzeuge / Contacts and Tools / Contacts et Outillage

2.1	EPIC CONTOOL	109
-----	--------------	-----

Gehäuse / Housings / Boîtiers

3.1	EPIC DA-VINCI H-A	133
	Tüllengehäuse / Hood / Capot	135
	Anbaugehäuse / Panel mount base / Embase encastrée	140
	Sockelgehäuse / Surface mount base / Embase en saillie	143
	Kupplungsgehäuse / Cable connector hood / Capot prolongateur	149
3.2	EPIC DA-VINCI H-B	153
	Tüllengehäuse / Hood / Capot	155
	Anbaugehäuse / Panel mount base / Embase encastrée	167
	Sockelgehäuse / Surface mount base / Embase en saillie	171
	Kupplungsgehäuse / Cable connector hood / Capot prolongateur	187
3.3	EPIC Eco H-B, ECO-Set/ECO H-B 6-24 Ag, ECO H-B 6-24 Tg	191

Kabelverschraubungen / Cable glands / Presse-étoupes

4.1	EPIC CERTOSA	197
-----	--------------	-----

Zubehör / Accessories / Accessoires

5.1	EPIC DUCO	207
	Schutzdeckel / Protective cover / Couvercle de protection	
5.2	EPIC CODIX	211
	Codierung / Coding / Codage	
5.3	EPIC DA-VINCI Perfect	215
	Bügel / Levers / Leviers	
5.4	EPIC ELMAC	219
	EMV-Schutz / EMC-Protection / Protection CEM	

Rundsteckverbinder / Circular connectors / Connecteurs circulaires

6.1	EPIC CIRCON LS 1	225
6.2	EPIC CIRCON R2.5	235
6.3	EPIC CIRCON PP1	245
6.4	EPIC CIRCON R3.0	249

Lichtwellenleiter: INTERBUS Anwendung / Fibre optics: INTERBUS application / Fibre optic: Système INTERBUS

7.1	EPIC BUS	257
-----	----------	-----

Allgemeine Verkaufs- und Lieferbedingungen / General conditions of sale and delivery / Conditions générales de vente et de livraison	262
---	-----

Artikelübersicht / List of part numbers / Rappel de numéros de référence	268
--	-----

Niederlassungen und Vertretungen weltweit / Branches and Agencies worldwide Etablissements et Représentants mondiaux	274
---	-----

Herzlich Willkommen in der Welt der CONTACT Steckverbinder

A warm welcome to the world of CONTACT Connectors!

Bienvenue dans le monde des connecteurs rectangulaires CONTACT !

Herzlich willkommen in der Welt der CONTACT Steckverbinder!

Ob Tüllengehäuse, Anbau, Sockel – oder Kupplungsgehäuse mit Quer- oder Längsbügel, Stift- oder Buchseneinsatz, Kontakte, Werkzeuge oder Verschraubungen, bei CONTACT finden Sie die richtige EPIC® Kombination für die verschiedensten Anwendungsbereiche aus Maschinenbau, Automobilindustrie, Roboter-, Elektro-, Prüf-, Meß-, Regel- und Gerätetechnik.

Dieser Katalog, Ausgabe C 2000, ist gültig ab April 1999. Mit Einführung dieser Ausgabe werden alle bisherigen Katalogsysteme ungültig. Für Schreib- bzw. Druckfehler übernimmt CONTACT keine Haftung. Für alle Angebote, Bestellannahmen und Lieferungen gelten ausschließlich unsere in diesem Katalog enthaltenen allgemeinen Verkaufs- und Lieferbedingungen.

A warm welcome to the world of CONTACT Connectors!

Whether you need the hood to mate with panel bases or surface mounting bases or a coupler hood for cable to cable connection. Whether you prefer single or double latching connectors, or chose to have the male or female insert in the base or hood. Whether you need screw or crimp termination, need tools or cable glands CONTACT can supply you with the correct EPIC™ combination. CONTACT has the widest range of products for applications including mechanical engineering, automotive, robotics, electrical, control, communication technology, test, instrumentation, closed loop control and equipment technology.

This catalogue issue, C 2000, is applicable with effect from April 1999. Upon introduction of this issue, all previous catalogue systems become invalid. CONTACT accepts no liability for typographical or printing errors. The general conditions of sale and supply contained in our catalogue are exclusively applicable to all quotations, acceptances of orders and deliveries.

Bienvenue dans le monde des connecteurs rectangulaires CONTACT !

Capots à douille, embases à encasturer, en saillie ou prolongateur, inserts mâles et femelles, contacts, outils ou boulonnerie : chez CONTACT, vous trouvez la combinaison EPIC® qu'il vous faut, quel que soit votre secteur d'activité : mécanique, automobile, robotique, appareillage électrique, automatismes, télécommunications, test, mesure et contrôle.

Ce catalogue, édition C 2000, est en vigueur à partir avril 1999. Il remplace et annule tous les catalogues antérieurs. CONTACT n'est pas responsable des erreurs de composition et d'impression. Pour toutes les offres, acceptations de commande et livraisons, seules sont valables nos conditions générales de vente et de livraison contenues dans le présent catalogue.

Agieren statt reagieren

Action not Reaction

Agir au lieu de Réagir

Unter diesem Motto starten wir in das neue Jahrtausend und werden im Bereich der schweren Steckverbinder Technologieführer mit weltweiter Präsenz. Auch in der LAPP GRUPPE spielen wir eine wesentliche Rolle. Dabei nutzen wir sinnvoll die Synergieeffekte, die sich in einer der führenden Firmengruppen auf dem Kabel- und Leitungsmarkt ergeben. Mit hoher Qualität und Innovationskraft erfüllen wir Ihre Anforderungen in den Bereichen Elektro- und Gerätetechnik sowie im Maschinenbau. Egal ob Sie eines unserer elektrischen Bauelemente oder unsere mehrpoligen Steckverbinder benötigen, die Verbindungen, die wir für Ihre Anlagen aufbauen, sind so gut wie die Kontakte, die wir zu unseren Geschäftspartnern halten. Gehen auch Sie mit uns die Erfolgspartnerschaft ein. Wir entwickeln individuelle Lösungen für Sie und bieten eine breite Palette an bewährten Produkten in der Steckverbindertechnologie. In jedem Betriebsbereich fördern wir die Eigenverantwortung unserer kompetenten Mitarbeiter. Eine schlanke Hierarchie und kooperativer Teamgeist optimieren die Zusammenarbeit von weltweit über 200 Mitarbeitern. So schaffen wir ein einzigartiges Unternehmen und erfüllen unseren Leitspruch mit Leben. Sie als Kunde ziehen den vollen Nutzen daraus. Denn Ihre Zufriedenheit ist auf Dauer der beste Gewinn.

CONTACT's mission statement for the New Millennium is: To achieve a world-wide presence and become leaders in the field of industrial connector technology. As a member of the LAPP GROUP, we play an essential role and are able to take advantage of the synergistic effect which are made possible through our association with a leading group of companies in the cable technology sector. In the areas of instrumentation technology, electrical and mechanical engineering, we meet your demands with high quality and innovative strength. The associations that we have with our customers and business partners are lasting ones. If you enter into a partnership of success with us, we will develop individual solutions to meet your needs and offer a broad range of proven products in the field of connector technology. In all areas of our company we encourage and support self-initiative and responsibility for every employee. A decentralised organisational structure coupled with a cooperative team spirit helps to optimise and support the cooperation between more than 200 employees worldwide. This is how we will fulfil our motto and become a unique organisation. You as a customer will receive the benefits and in the long run, your satisfaction is our best profit.

C'est avec ce mot d'ordre que nous désirons attaquer le 2^e millénaire et être présent au niveau mondial en tant que leader technologique dans le domaine de la connectique industrielle. Dans le GROUPE LAPP, nous avons notre rôle à jouer, c'est pourquoi nous profitons de l'effet de synergie créée par l'un des groupes leader sur le marché du câble. Avec une haute qualité et une force novatrice nous réalisons vos besoins dans les secteurs tels que l'électrotechnique et la machine outil. Notre souci est la liaison, peu importe que cela soit avec un composant électrique ou un connecteur multi pôles, n'hésitez pas à vous joindre à nous dans cette association constructive. Nous développons des solutions individualisées et vous soumettons dans la technologie de la connectique une large palette de produits de valeur. Une hiérarchie élancée et une équipe géniale, coopérative constituée de plus de 200 personnes optimisent notre travail commun. C'est ainsi que nous construisons une entreprise unique et vivons notre devise pleinement. Vous les clients en tirerons le plus grand profit, car votre satisfaction est, à longue échéance notre plus belle réussite.



Bernd Rath

- Geschäftsleitung -
- Managing director -
- Direction -

8 Gründe CONTACT zu kontaktieren

8 Reasons to "contact" CONTACT

8 Raisons de contacter CONTACT



1 Menschlichkeit

1 Cooperation

1 Rapport Humain

Das partnerschaftliche Verhältnis unserer Mitarbeiter stärkt das gegenseitige Vertrauen, fördert Eigenverantwortung und Teamarbeit. Kreative und begeisterte Mitarbeiter sind unser wertvollstes Kapital.

A partnership of cooperation among our employees strengthens mutual trust, encouraging and supporting initiative, responsibility and teamwork. Creative and enthusiastic employees are our most valuable capital.

L'engagement de nos partenaires renforce la confiance mutuelle, encourage le sens de la responsabilité personnelle et le travail en équipe. La créativité et l'enthousiasme de nos effectifs est notre meilleur capital.

2 Neues Entdecken

2 Innovations

2 Découverte

Neue Ideen führen zu neuen Technologien. Computergestützte Entwicklungen führen zu innovativen Produkten. Unsere Mitarbeiter engagieren sich, damit die Verbindung zu Ihnen stimmt.

New ideas lead to new technologies. Computerassisted developments lead to innovative products. Total commitment from all of our employees to ensure customer satisfaction.

De nouvelles idées nous mènent à de nouvelles technologies. Le développement de l'outil informatique aboutit à l'innovation. Nos partenaires misent tout sur CONTACT, afin que notre relation soit la meilleure.

3 Wertigkeit

3 Value

3 Valeur

Qualität, Zuverlässigkeit, Sicherheit und Präzision spiegeln sich wider in unseren Produkten.

Our products reflect quality, reliability and safety.

Qualité, confiance, sécurité et précision sont en étroite liaison avec nos produits.

4 Produkte
4 Products
4 Produits

Die EPIC® Baureihen umfassen mehr als 4000 Artikel, kundenspezifische Produkte und Werkzeuge für jede Anwendung. Wir entwickeln speziell nach Ihren Anforderungen und Wünschen.

The EPIC® ranges include more than 4000 items, custom-made types and tools to cover every eventuality, if you have a special product need we will design it for you.

Nous avons plus de 4000 articles à disposition et restons persuadés que, dans notre gamme EPIC®, outillage et produits spéciaux vous y trouverez votre bonheur si tel n'était pas le cas nous nous lancerions dans une fabrication spéciale.

5 Service
5 Service
5 Service

Wir halten die Verbindung zu Ihnen. Unser weltweites Vertriebs- und Servicenetz ist mit Rat und Tat immer in Ihrer Nähe. Sie erhalten Auskunft und Support vor Ort.

We keep in close touch with you. Our world-wide sales and service network is always in your proximity, committed to providing you with advice, assistance and support.

Nous gardons le CONTACT, n'hésitez pas à nous questionner. Notre service mondial est toujours à votre service, vous obtiendrez facilement soutien et renseignements.



6 Zertifikate
6 Certifications
6 Certifications

Unser Engagement und unsere Verantwortung für die Zukunft spiegelt sich in den Zertifikaten wider. Denn den CONTACT zu unseren Prinzipien werden wir nicht verlieren.

The certifications confirm our commitment and our responsibility for the future. We will not lose sight of our founding principles.

Cette certification confirme notre engagement et notre responsabilité pour l'avenir. Car nous ne désirons pas perdre notre savoir faire.

7 Mitglied der LAPP GRUPPE
7 Member of the LAPP GROUP
7 Membre de GROUPE LAPP

Verbindungen schaffen von der Gegenwart in die Zukunft. Profitieren Sie von der langjährigen Erfahrung einer starken Gruppe.

Create connections from the present to the future. Gain by the many years' experience of a powerful group.

Nouer des relations pour passer du présent à l'avenir. Profitons d'année d'expérience d'un grand groupe.

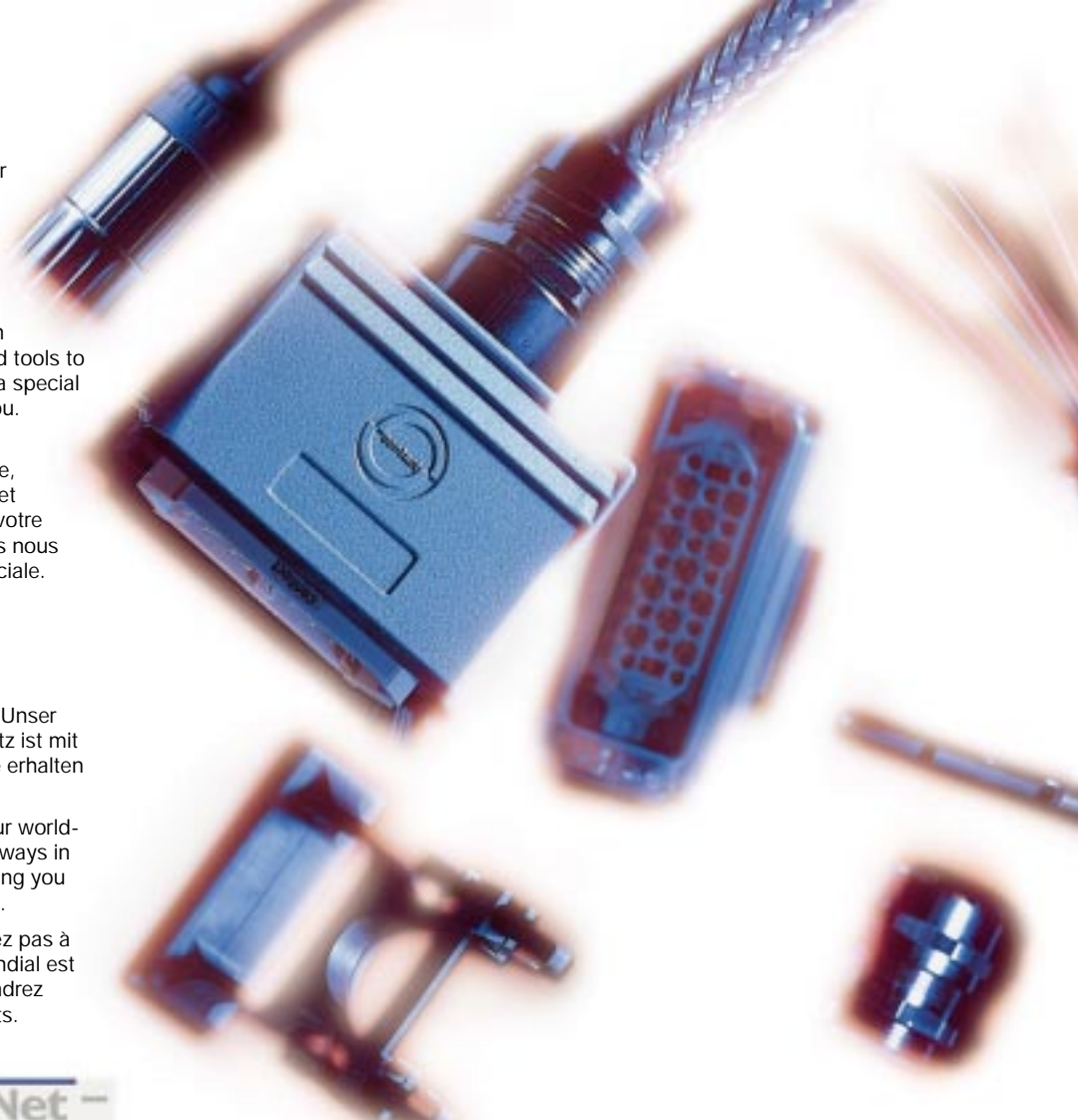

8 Beständigkeit
8 Consistency
8 Stabilité

Diese Verbindung besteht seit mehr als 30 Jahren – bis heute. Ein erster CONTACT führt zu einer dauerhaft funktionierenden Verbindung.

Established for over thirty years, one initial contact results in a lifelong and sound connection.

Cela fait plus de 30 ans que nous avons établi la liaison avec vous. Un premier CONTACT assure une réelle, sincère et longue coopération.



CONTACT Deutschland



CONTACT GmbH mit Stammsitz in Stuttgart-Vaihingen entwickelt, produziert und vertreibt unter dem Namen EPIC® elektrische Bauelemente, insbesondere mehrpolige Steckverbinder für die Elektro- und Nachrichtentechnik, Prüf-, Meß- und Regeltechnik sowie Maschinenbau- und Gerätetechnik. Mehr als 150 Mitarbeiter bieten seit 1966 weltweit Lösungen für kundenspezifische Applikationen und gestalten zukunftsweisende Innovationen auf dem Markt der Steckverbindertechnologie.

CONTACT GmbH has been located in Stuttgart-Vaihingen since 1966. The electrical connectors are sold under the brand name EPIC® and are frequently used in manufacturing, machinery, power supplies, cabinets and other signal and control applications. CONTACT has 150 employees in Stuttgart handling a Global market, all of these people are dedicated to improving connector technology throughout the market place.

CONTACT GmbH est installée à Stuttgart-Vaihingen; elle développe, produit et distribue sous le nom EPIC® des composants électriques, tout spécialement des connecteurs multi pôles pour les secteurs de l'électrotechnique, de la machine outil et de la technologie de précision. Plus de 150 effectifs proposent, depuis 1966 au niveau mondial, des solutions et des applications à des demandes spécifiques, pour innover la technologie du marché de la connectique.

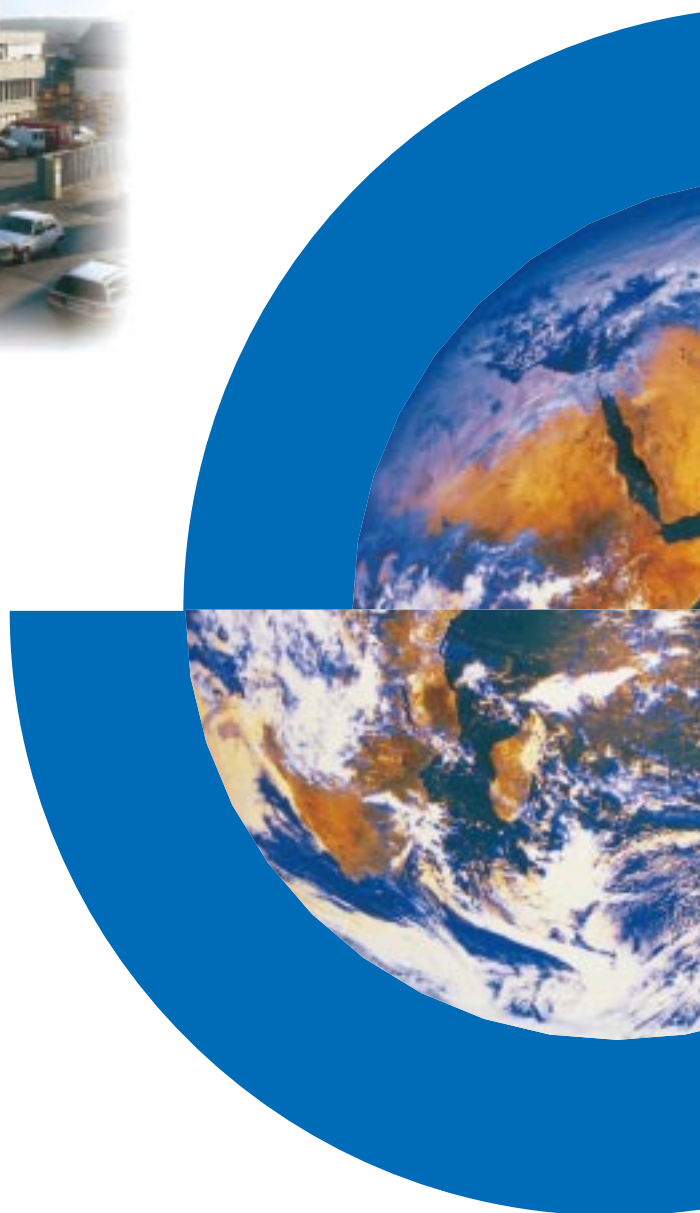

LAPP GROUP



Mehr als 1700 Mitarbeiter in 32 Einzelfirmen und 50 Vertretungen auf allen fünf Kontinenten machen die LAPP GRUPPE zum führenden Anbieter von Kabeln, Leitungen, Steckverbin-

dungen und Kommunikationstechnik. Die hochwertigen und zuverlässigen Produktreihen sind unter den Markennamen Ölflex, Unitronic, Skintop, Hitronic und Fleximark bekannt.

The Group has 1700 employees and 30 companies world-wide, together with distributors in all continents. The LAPP GROUP is a market leader for cable, harnessing and associated systems. The products are sold under the brand names of Ölflex, Unitronic, Skintop, Hitronic and Fleximark.

Plus de 1700 effectifs dans 30 sociétés et 50 distributeurs sur cinq continents représentent et poussent le GROUPE LAPP sur la voie de premier dépositaire de câbles, de connecteurs et de techniques de communication. Les lignes de produits hautes en qualité et en performances sont commercialisées sous les noms de: Ölflex, Unitronic, Skintop, Hitronic et Fleximark.

Ein 25-köpfiges verkaufs- und marketing-orientiertes Team baut seit 1985 die Marktführerschaft im Bereich der schweren Steckverbinder aus. Mit Serviceleistungen, kundenspezifischen Konfektionierungen und einem flächendeckenden Distributorennetz ist CONTACT auf den britischen Inseln vertreten.

Formed in 1985, we have a dedicated team of 25 people in our London operation. We are the market leader for industrial connectors and accessories used in hostile environments. The operation has focused on delivering a high level of service and offers an innovative variety of solutions to the customer including all their harnessing needs.

CONTACT UK



Un groupe de 25 personnes commerciaux et spécialistes en marketing poussent depuis 1985 la société sur la voie de leader dans le domaine de la connec-

tique. CONTACT est apprécié sur l'île pour, son service, sa confection de produits spécifiques sur demande et son solide réseau de distributeurs.

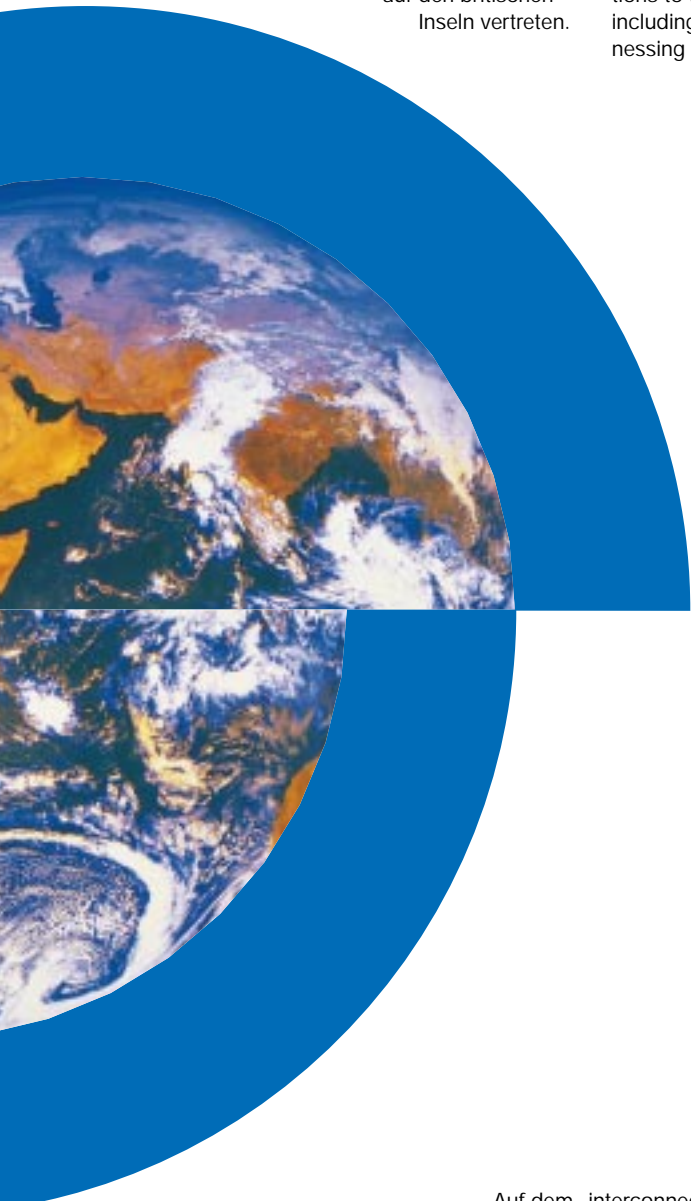

CONTACT France



In Forbach betreiben unsere Mitarbeiter seit 1990 ein umfangreiches Warenlager für kurzfristige Auslieferung der kompletten EPIC® Produktpalette. In jeder französischen Wirtschaftsregion werden Interessenten und Kunden individuell und kompetent durch geschulte Außendienstmitarbeiter betreut. Impulse für Produktentwicklungen werden an das Stammhaus weitergeleitet.

Our sales office has been based in Forbach since 1990, and our experienced staff operate a speedy delivery service from this depot. All regions of France are covered by highly trained technical sales personnel. Customers' special needs are transmitted to our engineering group at our factory in Stuttgart.

A Forbach nos collègues ont développé une aire de stockage avec une gamme complète des produits EPIC® afin de satisfaire des livraisons rapides. La France est découpée en plusieurs régions et est représentée par 9 agents qui font la promotion de nos produits à la recherche de nouveaux marchés.

Auf dem „interconnection and assembly“ - Markt in den USA, Kanada und Mexico bietet CONTACT USA ein ausgefeiltes Produktprogramm an. Kundenspezifische Lösungen, neue Produktserien und Kabelkonfektionierungen runden das Programm ab. CONTACT USA betreut seine Kunden erstklassig mit einem Distributorennetz und einem Auslieferungslager, das alle Anforderungen des amerikanischen Marktes erfüllt.

Servicing the US, Canada and Mexico, CONTACT Electronics offer a comprehensive range of connectors and accessories, including a cable harnessing service throughout the continent. From its warehouse and through an extensive national network of representation, a first class service with short turn round times is available.

CONTACT USA



Par le biais du Marché „interconnection and assembly“ aux USA, le Canada et le Mexique, CONTACT aux Etats Unis représente la gamme complète de nos produits. Des réalisations spécifiques pour certains clients, les nou-

veaux produits, la confection de câbles spéciaux complètent agréablement la gamme. CONTACT USA fidélise sa clientèle avec un stock important à disposition et un sérieux réseau de distribution solidement implanté.

Technical CONSIDERATIONS

Technisches Vorwort / *Technical Considerations* / *Préambule technique*

The most important considerations for a heavy duty connector are its electrical characteristics, its mechanical characteristics and the materials from which it is manufactured. The heavy duty connector provides safe connection and disconnection of electrical power or signals within robust housings which are suitable for hostile environments. (connectors should never be mated or unmated under load)

The construction of a rectangular connector can be selected specifically for a customer's requirement. EPIC® industrial connectors from Contact are made up of various components (housings and contact inserts).

The various components of the heavy duty rectangular connector are purchased individually and made up on a modular principle. A wide range of housing sizes and many options of inserts and contacts make it possible to design the ideal connector for each application.

The following individual components have to be purchased in order to produce the complete rectangular connector:

1. Cable Gland:

The Cable Gland provides a seal between the cable and the connector housing. It may also be used to offer additional functions like strain relief and braid continuity for EMC protection.

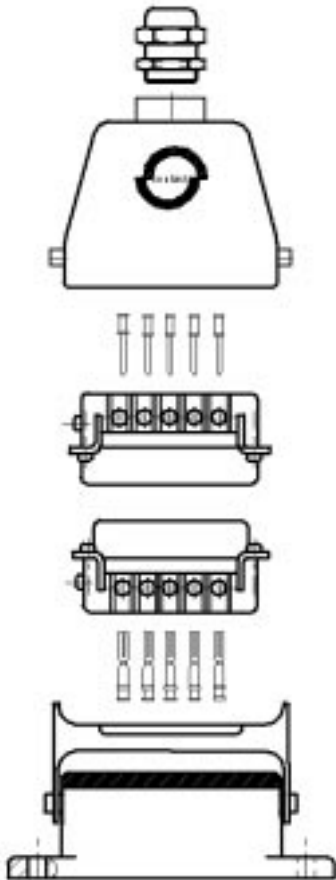

2. Hood:

The connector housing for the cable entry.

3. Male insert:

Types of contact termination

- Screw
- Crimp (Stamped or machined)
- Cage clamp

4. Female insert:

Types of contact termination

- Screw
- Crimp (Stamped or Machined)
- Cage clamp

5. Base:

Panel mounting:

(cable entry though cut out in panel)

or

Surface mounting

(cable entry through a gland into the side of the connector base)

or

Cable Connector Hood:

cable to cable connection

Technical CONSIDERATIONS

Technisches Vorwort / *Technical Considerations* / *Préambule technique*



Housings:

Hood:

A hood may have a top or angle (side) entry of different PG sizes to accommodate a wide range of cable diameters. The hood can be mated with either a surface or panel mounting base, or a cable coupler hood (for cable to cable connection).



Panel Base housing:

The panel base is wired from below through a hole cut in a panel. The panel base is attached to the surface of a control panel for connection of control or power cables.

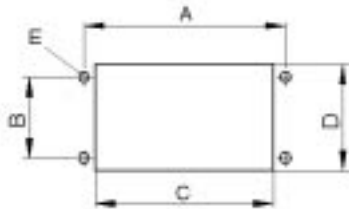

Panel cut out for panel mount base (mm)

Panel mount base	A	B	C	D	E
H-A 3	30	—	21	21	3,3
H-A 10	70	17,5	57,5	24	3,6
H-A 16	86	17,5	73,7	24	3,6
H-A 32	92	42	74,2	48,4	4,3
H-A 48	110	65	85,5	71	5,5
H-B 6	70	32	52,2	35	4,3
H-B 10	83	32	65,2	35	4,3
H-B 16	103	32	85,5	35	4,3
H-B 24	130	32	112,2	35	4,3
H-B 32	110	65	85,5	71	5,5
H-B 48	148	70	124	82	7



Surface Base housing:

The surface base is a complete enclosure only offering cable entry through a cable gland mounted either on one or both sides of the base.



Cable Connector Hood:

The cable connector hood mates with a top entry hood to offer cable to cable connection. This is frequently used to extend cables.

locking lever (Latches) types:

There are two types of locking levers:

- Single locking lever (which bolts about the longer axis of the connector)
- Double locking lever (which bolts about the shorter axis of the connector)

The new Da-Vinci Perfect Series locking levers are removable and can be mounted either on the hood or base as desired. This is valid for

Double locking lever: H-B10/16/24, H-A32

Single locking lever: H-B 6



Technical CONSIDERATIONS

Technisches Vorwort / *Technical Considerations* / *Préambule technique*



Cable Gland:

When the correct cable gland is selected to match the cable diameter a good seal is ensured. Cable Glands are available to fulfill many additional requirements. A gland with a saddle clamp supplies good strain relief or one with a neoprene boot offers anti-kinking. These devices help to prevent damage to the connection or the cable. In addition cable glands are available for use with cables improving EMC performance by taking the screen to the body of the connector.



Male and Female Inserts:

(NB: Information regarding materials is provided on the following pages)

The male and female inserts are the receptacles for the male and female contacts respectively, and is the interface for the electrical connection. Cable is terminated to the contacts. Inserts provide the electrical insulation.



Contact types:

(NB: Information concerning materials/contact coatings is provided on the following pages)

Screw termination:

This simple type of termination is distinguished by its ease of maintenance. No special tool is required, just a screwdriver to undo and to tighten up the terminal screws.

Screw connection technology (as per DIN 0609)

Conductor section (mm ²)	1	1,5	2,5	4	6	10
Screw thread:	M 2,6	M 3	M 3	M 3,5	M 4	M 4
Test torque Nm:	40	50	50	80	120	120



Crimp termination:

The purpose of crimping is to produce a good mechanical, electrical and gas-tight connection. This should remain unchanged with regard to quality in the long-term, and should thus be reliable.

Crimping also reduces termination time and allows the designer to achieve more connections than screw termination would permit in the same space

Hand-operated tools or crimping machines can be used to assemble crimp contacts. The following points must be harmonised with each other in order to obtain the ideal crimping result:

- Cross section dimension/gauge size and structure of the cable
- Contact type and size
- Tool and tool setting



There are two different contact types: - Machined and Stamped. These two types of contact have differing characteristics in terms of quality and how the termination is made.

Stamped contacts: The crimping sleeve allows a wider range of wire gauges to be crimped. This guarantees reliable crimping quality. Furthermore, the insertion and extraction force is usually lower with stamped pin and socket contacts. This is achieved by the large contact area and the spring characteristics of the stamped contact's material. Stamped contacts can be supplied on a bandolier for use with automatic feed crimping tools.

Machined contacts: With this popular type of contact, the suitable contact size is matched to the wire gauge of the cable. The correct crimping tool or die must be used.



Cage Clamp termination:

This type of termination is noted for its ease and speed of fitting without an additional tool. The compensating effect of the cage clamp enables good contact to be maintained in the long term.

Technical CONSIDERATIONS

Technisches Vorwort / *Technical Considerations* / *Préambule technique*

Housing sizes / inserts:

		inserts								
Housing	H-A	STA	H-BE	H-BS	H-BVE	H-D	H-DD	MC	TB-H-BE	TB-H-D
H-B 6			H-BE 6				H-DD 24	MC-R 6 2 Modules	TB-H-BE 6	TB-H-D 16
H-B 10			H-BE10		H-BVE 3		H-DD 42	MC-R 10 3 Modules	TB-H-BE 10	TB-H-D 24
H-B 16			H-BE 16	H-BS 6	H-BVE 6	H-D 40	H-DD 72	MC-R 16 5 Modules	TB-H-BE 16	TB-H-D 40
H-B 24			H-BE 24		H-BVE 10	H-D 64	H-DD 108	MC-R 24 7 Modules	TB-H-BE 24	TB-H-D 64
H-B 32			H-BE 32	H-BS 12		H-D 80	H-DD 144	MC-R 2x16 10 Modules		2 x TB-H-D 40
H-B 48			H-BE 48			H-D 128	H-DD 216	MC-R 2x24 14 Modules		2 x TB-H-D 64
H-A 3	H-A 3/4	STA 6				H-D 7/8				
H-A 10	H-A 10	STA 14				H-D 15				
H-A 16	H-A 16	STA 20				H-D 25				
H-A 32	H-A 32	2 x STA 20				H-D 50				
H-A 48	H-A 48									

Technical data:

Design series	Voltage as per VDE 0110		UL		CSA		SEV	
	Voltage V (AC)	Current A	Voltage V (AC)	Current A	Voltage V (AC)	Current A	Voltage V (AC)	Current A
EPIC® H-A 3/4 10-48	250 250	10 16	600 600	10 14	600 600	10-16 20	250 250	10 10
EPIC® STA 6-20	60	10	48	10	48	10		
EPIC® H-BE 6-48	400	16	600	16	600	10	400	16
EPIC® Cage clamp 6-48	500	16	600	16	600	16		
EPIC® H-BS 6-12	400	35	440	35	600	35	400	35
EPIC® H-BVE 3-10	600	16	600	16	600	16	600	16
EPIC® H-D 7/8 15-128	42 / 250 250	10 10	250 250	10 10			250 250	10 10
EPIC® H-DD 24-216	250	10	600	8,5	600	20	250	10
EPIC® MC 3-pin module 5-pin module 10-pin module 20-pin module HE module	630 400 250 63 630	40 20 10 5 25	600 400 250 63	40 20 10 5	600 400 240 60	35 16 10 5	630 400 250 63	40 20 10 5
Coaxial module High voltage module High voltage module Cage clamp module Blank module	1000 1000 400	16 50 16						
EPIC® TB-H-BE 6-24	380	16	600	16	600	16	250	10
EPIC® TB-H-D 16-64	250	10	600	7	600	10	250	10

UL, CSA under preparation

Technical CONSIDERATIONS

Technisches Vorwort / *Technical Considerations* / *Préambule technique*

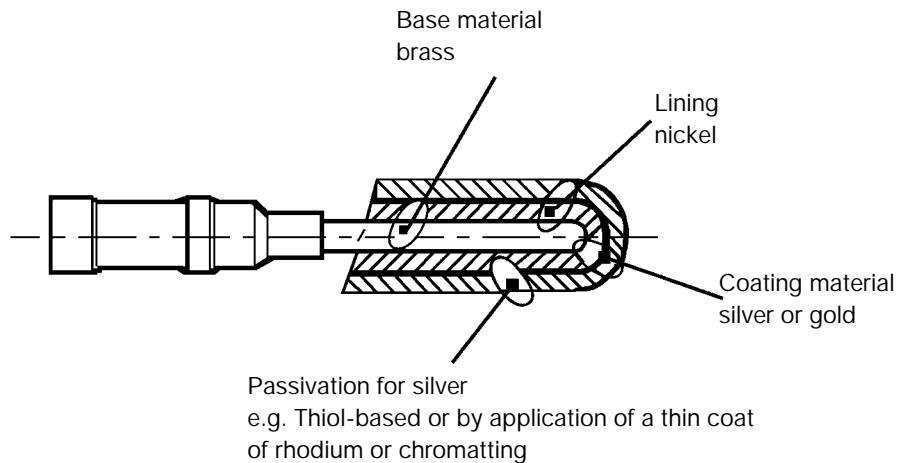

Contact Material Details :

The coating of the base material with a precious metal is necessary to guarantee a long lasting and good connection. The contacts are plated normally by galvanic processes. To reach a long-lasting plating, there are some requirements for the contact and the plating material

Requirements on contact material:

- Good dimensional stability
- High corrosion resistance
- Good electrical conductivity

Brass (copper zinc alloy) is used for its good mechanical properties and its electrical conductivity. Because it is also relatively economical it has become one of the most preferred contact materials

Requirements on contact coatings:

- High abrasion resistance
- High hardness
- Low contact resistance
- High corrosion resistance
- Low porosity
- Good coat formation
- Solderability

Silver or gold are the normal choice for surface coating.

- Silver possesses the highest electrical conductivity of any metal and is the most cost-effective precious metal. With sulphur or sulphurous products in the ambient air, a brownish to black oxide coating made up of silver sulphide (Ag_2S) will rapidly be formed. However, this coating will break up in the process of mating and will be broken down by high currents, so that the necessary electrical conductivity is maintained. Passivation of the silver surface will delay the formation of the oxide coating and will reduce the mating and unmating forces.

- Gold is the most tarnish resistant precious metal. Formation of oxides and sulphides can be discounted. Gold contacts are distinguished by their low mating and unmating forces. They are mainly used for transmission of signals with low current and voltage values.

Alternative materials for surface coating:

- Nickel is normally applied as a corrosion protection and blocking layer. Furthermore, the relatively high hardness of the Ni coating has a positive effect on wear characteristics.
- Tin or Tin/Lead is one of the most frequently employed metals for contacts, especially in the automotive field. As an aid to soldering, virtually all partially coated strips in the connection area are coated with tin or Tin/Lead. Due to the low hardness of tin, the mating forces are very high and this makes it unsuitable for connectors that are designed for a high number of mating cycles.

Technical CONSIDERATIONS

Technisches Vorwort / *Technical Considerations* / *Préambule technique*

Terms / glossary

Connectors:

Connectors are a generic device for providing an electrical interface between electrical equipment and/or a power source. Our connectors may not be mated or unmated under load.

Mating cycles:

Mating cycles are the number of insertion and extraction cycles a connector can withstand before electrical or mechanical failure in relationship to the connector's design specification.

Upper limit temperature:

The upper limit temperature is the maximum permissible temperature, at which a Heavy Duty connector can still be operated, due to heating up of the contacts by the ambient temperature or other environmental conditions.

Lower limit temperature:

The lower limit temperature is the minimum permissible temperature at which a Heavy Duty connector can still be operated.

Air Gap

The minimum gap of air between two conducting surfaces permissible at given voltages.

Creep distance:

The minimum dimension along the surface of an insulating material between two conducting surfaces.

Rated voltage:

The rated voltage is the voltage according to which the connectors are designed and related to the relevant operating characteristics.

Rated current:

The rated current is the current at which a connector can continuously (not intermittently) conduct through all contacts simultaneously without exceeding the upper limit temperature.

Test voltage:

The test voltage is the maximum voltage at which a connector will not be subjected to flashover under the set conditions.

Technical CONSIDERATIONS

Technisches Vorwort / Technical Considerations / Préambule technique

Pollution:

Numerical value which states the anticipated pollution in the micro-environment.

Pollution level 1:

No pollution or only dry, non-conductive pollution occurs.

This pollution has no influence.

e.g.: Open, unprotected insulations in air-conditioned or clean dry rooms.

Pollution level 2:

Only non-conductive pollution occurs. Occasionally, however, it may be anticipated that transient conductivity arises due to condensation.

e.g.: Open unprotected insulations in residential, commercial or business premises (fine mechanical engineering workshops, laboratories, test areas, rooms used for medical purposes).

Pollution level 3:

Conductive pollution arises, or dry, non-conductive pollution which becomes conductive because condensation has to be anticipated.

e.g.: Open unprotected insulations in rooms of industrial, commercial and agricultural companies, unheated storage rooms, boilerhouses and workshops

Pollution level 4:

Contamination leads to continuous conductivity caused by condensation or other environmental contaminants.

e.g.: External exposed installations subject to all environmental changes.

Pollution level 3 is typical for an industrial environment, whilst pollution level 2 is typical for households.

Insulation materials:

Insulation materials are categorised into 4 groups according to the CTI values.(Comparative Tracking Index)

Insulation material group I $600 \leq \text{CTI}$

Insulation material group II $400 \leq \text{CTI} < 600$

Insulation material group IIIa $175 \leq \text{CTI} < 400$

Insulation material group IIIb $100 \leq \text{CTI} < 175$

Comparative Tracking Index

The test for determination of the comparative index of tracking (CTI or comparative tracking index) as per IEC 112 provides a comparison of the characteristics of various insulating materials under test conditions. By dripping an aqueous solution onto a horizontal surface the electrolytic conduction can be measured. This produces a qualitative result. When the insulating material is introduced to the tracking a quantitative comparison can be measured, i.e. the comparative tracking index.

Switch contact:

If the construction of the circuit requires that for safety reasons, e.g. for neutral conductors, one or several contacts of a connector have to make contact first upon mating, or have to be separated last upon unmating, then connectors with switch (extended) contacts are used.

EMC (electromagnetic compatibility):

The capacity of an electrical installation to function satisfactorily in its electromagnetic environment without an unacceptable influence to the environment which also includes other installations (DIN/VDE 0870, Section 1)

Coding:

Coding is a system by which it is possible to prevent interfacing confusion between adjacent connectors which are of the same configuration. This is useful if two or more connectors of the same type are mounted on the same unit.

Polarisation:

Polarisation is a method used on connectors which prevents incorrect mating of male and female inserts eg: pin1 to pin1.

Technical CONSIDERATIONS

Technisches Vorwort / Technical Considerations / Préambule technique

IP mode of protection:

IP - "insulation Protection" is a measure of protection against water and partial ingress that a device will withstand. The level of protection offered by a device is laid down in the manufacturer's specification according to DIN 40 050.

The first digit of the code states the level of protection against partial ingress and the second digit states the level of protection against penetration of water.

Modes of protection as per DIN 40050

Degrees of protection against solid foreign bodies

First

Code

- | | |
|---|--|
| 0 | No particular protection |
| 1 | Protection against penetration of solid foreign bodies whose Diameter exceeds 50 mm (large foreign bodies) ¹⁾
No protection against intentional access
e.g. by hand, but exclusion of larger parts of the body |
| 2 | Protection against penetration of solid foreign bodies whose diameter exceeds 12 mm (medium-sized foreign bodies) ¹⁾
to exclude fingers or similar parts |
| 3 | Protection against penetration of solid foreign bodies whose diameter exceeds 2.5 mm (small foreign bodies) ^{1) 2)}
to exclude tools, wires or similar items whose thickness exceeds 2.5 mm |
| 4 | Protection against penetration of solid foreign bodies whose diameter exceeds 1 mm (granular foreign body) ^{1) 2)}
To exclude tools, wires, or similar items whose thickness exceeds 1 mm |
| 5 | Protection against harmful accumulations of dust. Penetration of dust is not entirely preventive; but dust must not penetrate in such quantities that the mode of operation of the equipment unit is affected (dust protection) ³⁾
Complete contact prevention |
| 6 | Prevention of penetration of dust (dust proof)
Complete contact prevention |

¹⁾ In the case of operating media of protection levels 1 to 4, consistently or inconsistently formed foreign bodies with three dimensions perpendicular to each other and larger than the corresponding diameter numerical values are prevented from entering.

²⁾ For degrees of pollution 3 and 4, the application of this table is appropriate for operating media with drain holes or cooling air apertures which are the subject of the responsibility of the corresponding expert committee.

³⁾ For protection level 5, the application of this table is appropriate for operating media with drain holes, and comes under the responsibility of the respective expert committee.

Degrees of protection against water

Second

Code

- | | |
|---|---|
| 0 | No particular protection |
| 1 | Protection against water dropping perpendicularly. No harmful effect must arise (water drip) |
| 2 | Protection against water dropping perpendicularly. No harmful effect must arise with an equipment unit 15° in relation to its normal position (casing) (obliquely water drip) |
| 3 | Protection against water dropping at any angle of up 60° to the perpendicular. No harmful effect must arise (water spray) |
| 4 | Protection against water which splashes onto the equipment unit (e.g. casing) from any direction. No harmful effect must arise (water splash) |
| 5 | Protection against water steam from a jet which is directed against the equipment unit (casing) from any direction. No harmful effects must arise (water spray) |
| 6 | Protection against heavy sea or powerful water jet. Water must not penetrate the operating equipment in harmful quantities (flooding) |
| 7 | Protection against water if the operating equipment is dipped in water under certain pressure and time Water must not penetrate in harmful quantities (dipping) |
| 8 | The operating media (casing) is suitable for permanent dipping in water under conditions which are to be defined by the manufacturer (immersion). ¹⁾ |

¹⁾ This level of protection normally relates to an air-tight field operating medium. For certain operating media, however, water may penetrate provided that there is no harmful effect

Technical CONSIDERATIONS

Technisches Vorwort / *Technical Considerations* / *Préambule technique*

Derating Curve:

The derating curve indicates the maximum current that can permanently and simultaneously flow through all connections if the component is exposed to ambient temperatures below its upper limit temperature.

The upper limit temperature of a component is determined by the materials. The maximum temperature is calculated from the ambient temperature and from heating due to current loading, it must not exceed the upper limit temperature of the component. The derating of a component is not a constant value, but decreases hand-in-hand with the increase in component ambient temperature. Furthermore, current loading capacity is dependent upon geometry, the materials employed, the number of poles and the conductor.

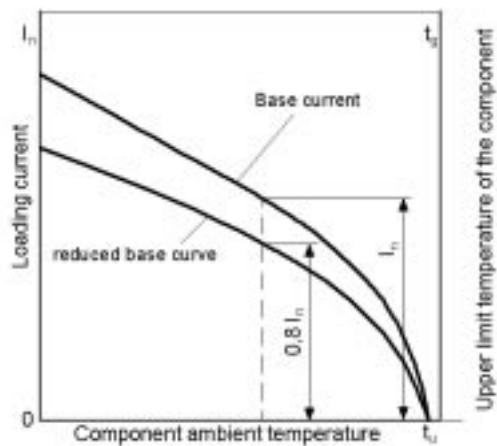

Since it is not advisable to use Heavy Duty connectors at their loading limits, the base curve is reduced. If the loading currents are reduced to 80%, then this produces the reduced base curve in relation to the various connectors and measurement uncertainties at which temperature measurements are taken into account. Experience shows that the reduced base curve is a successful popular application.

NB: Only the reduced base curve is reproduced on the following derating curves for inserts.

British and US comparative sizes for cables and lines

In the US, sizes of copper conductors for high current and telecommunication purposes are usually stated in AWG numbers. The following comparisons apply:

AWG Nr.	Dia- meter mm	Section mm ²	AWG Nr.	Dia- meter mm	Section mm ²
500	17,96	253	16	1,29	1,31
350	15,03	177	18	1,024	0,823
250	12,70	127	20	0,813	0,519
4/0	11,68	107,2	22	0,643	0,324
3/0	10,40	85	24	0,511	0,205
2/0	9,27	67,5	26	0,405	0,128
1/0	8,25	53,5	28	0,320	0,0804
1	7,35	42,4	30	0,255	0,0507
2	6,54	33,6	32	0,203	0,0324
4	5,19	21,2	34	0,160	0,0200
6	4,12	13,3	36	0,127	0,0127
8	3,26	8,37	38	0,102	0,00811
10	2,59	5,26	40	0,079	0,00487
12	2,05	3,31	42	0,064	0,00317
14	1,63	2,08	44	0,051	0,00203

Technical CONSIDERATIONS

Technisches Vorwort / Technical Considerations / Préambule technique

Materials

PA (Polyamides)

Polyamides are high-impact, very tough thermoplastics which exhibit very good electrical insulation characteristics, favourable tracking characteristics and resistance to flashover. The greater the proportion of filling agents, the less the water absorption and the better the dimensional stability. Their specific surface resistance, due to humidity absorption, is somewhat less than for other plastics, but there is the advantage that this reduces the tendency for a build-up of electrostatic charge and thus the tendency for PA components to attract dust is avoided.

These characteristics mean that polyamides are suitable for production of casings for electrical plant.

Typical application: Da-Vinci Perfect clip-on information tags, high-voltage modules, plastic frame grips;

PC (Polycarbonate)

Polycarbonate is an amorphous thermoplastic. It is distinguished by high strength, viscosity, hardness, rigidity and good resistance to heat & cold in relation to its form, and good electrical characteristics. PC is a glass-clear, easily-dyed plastic with very low water absorption, and exhibits high dimensional precision, low wastage and good processability.

Typical application: Inserts/insulators, frames and individual modules for the modular system.

PBT (Polybutylenterephthalate)

Polybutylenterephthalate is a thermoplastic polyester and is distinguished by its high rigidity, high stability of form under heat, low creep, low water absorption of <0,2%, high dimensional stability and good to very good electrical characteristics. It is a tough, viscous plastic with high abrasion resistance, high dimensional stability and long-term strength combined with good slip & wearing characteristics.

Typical application: inserts/insulators

Chemical resistance of plastics

Diluted acid	PA 6 GF	PA 66 GF	PC GF	PBT GF
Acetone	+	+	+	+
Aqueous ammoniac	+	+	●	+
Benzene	+	+	+	+
Benzol	+	+	+	+
Diesel oil	+	+	●	+
Concentrated acetic acid	+	+	+	+
Alkaline potassium	●	●	●	○
Methanol	●	●	●	+
Engine oil	○	○	●	+
Diluted alkalis	+	+	+	+
Chlorhydrocarbons	+	+	●	+
Outdoor exposure	+	+	●	○
Cold water/seawater	+	+	○	+

+ = resistant; ○ = conditionally resistant; ● = non-resistant

Electrical, thermal and mechanical values

Electrical values

	Unit	PA 6 GF	PA 66 GF	PC GF	PBT GF
Flashover resistance (DIN 53481; VDE 0303)	Ed ¹⁾ kV/mm	80 / 40	> 80 / 40	35	100
Tracking current resistance (DIN 53480; VDE 0303)	CTI	> 500	> 500	> 125 bis 250	> 500

Thermal values

Temperature limit for short-term application	° C	180	200	165	190
Temperature limit for long-term application	° C	105	120	130	140

Mechanical values

Density (DIN 53479)	g / cm ³	1,35	1,35	1,34	1,53
Modulus of elasticity in the flexional and tensile test (DIN 53457)	Ez ¹⁾ MPa	8500 / 6000	9700 / 7500	6000	10000
Absorption of humidity in NK until occurrence of saturation (DIN 5714)	%	2,1	1,5	0,13	0,13

1) Numerical information relates to both dry & atmospherically humid conditions

Technical CONSIDERATIONS

Technisches Vorwort / Technical Considerations / Préambule technique

Dichtungswerkstoffe:

NBR (e.g. Perbunan)

Synthetic rubber is used for parts with high resistance to fuels, oil, fat and aliphatic solvents at high temperatures. The durability of the material can be varied by the compounds used during manufacture, to protect against Ozone or the prevailing environmental conditions.

O Rings are used in various applications, e.g. Electrical and automotive industry, hydraulics, mechanical engineering, oil industry for membranes, fuel hoses, seals, formed items, plate gaskets etc.

Typical application: Seals and gaskets for rectangular connectors and glands.

FPM (e.g. Viton)

this fluoroelastomer is commonly used for rubber parts and withstands fuel, oil, lubricants, many acids and chemicals during extreme thermal stress. Viton has also good mechanical qualities, flame resistance and high durability against ozone and environmental impacts of every kind.

Typical application: Seal in circular connector type A and glands.

Chemical, thermal and mechanical values

Abbreviation	NBR	FPM
Commercial name	Perbunan N® Hycar	Viton / Fluorel®
Shore A hardness range at standard solid quality toleranz = ± 5° Shore approx	25 bis 40	60 bis 90
Tear strength N / mm ² bei +20°C to	Approx 20	Approx 17
General weather-resistance	good	excellent
Ozone resistance	satisfactory	excellent
Resistance to oil	excellent	excellent
Resistance to fuel	good	excellent
Resistance to solvent	partially good	very good
General resistance to acids	satisfactory	very good
Temperature resistance:		
a) Short-term: prox	- 40° to + 150°C	- 30° to + 280°C
b) Long-term: prox	- 30° to + 120°C	- 20° to + 230°C
Vapour resistance	good	satisfactory to good
Can be supplied in foodstuffs products	yes	no

EPIC® Rechtecksteckverbinder
EPIC® Rectangular Connectors
EPIC® Connecteur Rectangulaire





Qualität, Funktionalität und Prozeßsicherheit. Drei Eigenschaften, ein Markenname: EPIC®. Rechtecksteckverbinder überzeugen durch innovative und formvollendete Gehäuseformen mit der einzigartigen Da-Vinci Perfect Bügelgeneration.

Quality, functionality and safety are the three key words that describe the brand name EPIC®. These rectangular industrial connectors are renowned for their innovative electrical design and physical characteristics. The unique "Da-Vinci Perfect" housings and levers make them ideal for factory automation applications.

Qualité, fiabilité, sécurité accrue, trois critères et un nom : EPIC®, nous persuadent pour ce Connecteur Rectangulaire avec la forme novatrice de son capot et ses leviers nouvelle génération Da-Vinci Perfect.

Technische Daten / Technical Data / Caractéristiques techniques

Baureihe Series Série	Kontaktzahlen No. of contacts N° de contacts	Bemessungsspannung rated tension Tension nominale	Bemessungsstrom Rated current Intensité nominale	Anschlußart Termination Raccordement
EPIC® H-A	3 - 48	VDE: 250 V UL: 600 V CSA: 600 V SEV: 250 V	VDE: 10/16 A UL: 10/14 A CSA: 10/16/20 A SEV: 10 A	schraub screw à visser
EPIC® STA	3 - 20	VDE: 60 V UL: 48 V CSA: 48 V SEV:	VDE: 10 A UL: 10 A CSA: 10 A SEV:	schraub, lot screw, solder à visser, à souder
EPIC® H-BE	6 - 48	VDE: 400 V UL: 600 V CSA: 600 V SEV: 400 V	VDE: 16 A UL: 16 A CSA: 10 A SEV: 16 A	schraub, crimp screw, crimp à visser, à sertir
EPIC® H-BS	6 - 12	VDE: 500 V UL: 600 V CSA: 600 V	VDE: 16 A UL 16 A CSA: 16 A	Käfigzugfeder cage clamp lame de pression
EPIC® H-BE	6 - 12	VDE: 400 V UL: 440 V CSA: 600 V SEV: 400 V	VDE: 35 A UL: 35 A CSA: 35 A SEV: 35 A	schraub screw à visser
EPIC® H-BVE	3 - 10	VDE: 600 V UL: 600 V CSA: 600 V SEV: 600 V	VDE: 16 A UL: 16 A CSA: 16 A SEV: 16 A	schraub screw à visser
EPIC® H-D	7 - 128	VDE: 250 V UL: 250 V CSA: SEV: 250 V	VDE: 10 A UL: 10 A CSA: SEV: 10 A	crimp crimp à sertir
EPIC® H-DD	24 - 216	VDE: 250 V UL: 600 V CSA: 600 V SEV: 250 V	VDE: 10 A UL: 8,5 A CSA: 20 A SEV: 10 A	crimp crimp à sertir
EPIC® MC	3 - 280	VDE: 100-1000 V UL: 63-630 V CSA: 63-630 V SEV: 63-630 V	VDE: 5-40 A UL: 10-40 A CSA: 5-40 A SEV: 5-40 A	crimp crimp à sertir
EPIC® TB-H-BE	6 - 24	VDE: 380 V UL: 600 V CSA: 600 V SEV: 380 V	VDE: 16 A UL: 10/16 A CSA: 10/16 A SEV: 10 A	schraub screw à visser
EPIC® TB-H-D	16 - 64	VDE: 250 V UL: 600 V CSA: 600 V SEV: 250 V	VDE: 10 A UL: 7 A CSA: 10 A SEV: 10 A	schraub screw à visser

1.1 EPIC® H - A

Einsätze / Inserts / Inserts

Überall dort, wo das Platzangebot begrenzt ist, finden die „Kleinen“ H-A 3/4 ihren Einsatz. Die bewährten EPIC® H-A 10 - 48 Einsätze gibt es jetzt mit kurzem PE - Anschluß. Bei bis zu 2,5 mm² Anschlußquerschnitt, einzigartig. Evolution im Kleinen für Ihre Sicherheit.

The "small" H-A 3 / 4 inserts are used wherever space is limited. The proven EPIC® H-A 10 - 48 inserts now have a shortened PE connection. Unique, because the wire cross-section can still be up to 2.5 mm². Evolution in miniature for your safety.

Partout où la place est limitée, les "petits" inserts H-A 3/4 trouvent leur domaine d'utilisation. Les inserts EPIC® H-A 10-48 sont maintenant équipés d'une borne terre raccourcie. La section du fil peut toujours être de 2.5 mm² maxi. Une petite évolution technique.

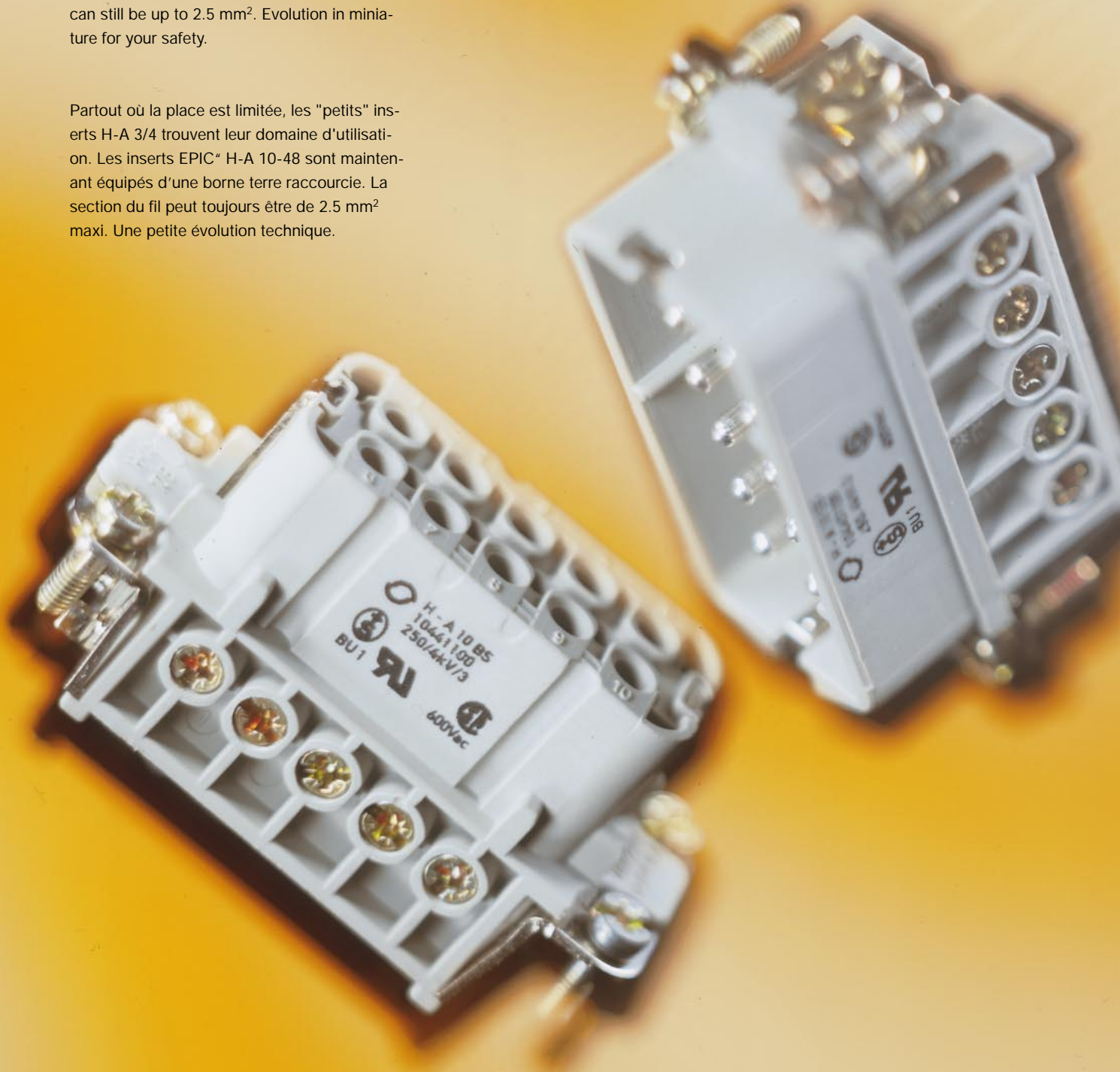

1.1 EPIC® H - A

Einsätze / Inserts / Inserts

Technische Daten:

- Kontaktzahlen: 3, 4, 10, 16, 32, 48 (+ PE)
- Bemessungsspannung: . . . VDE: 250 V EPIC® H-A 3-48
 UL: 250 V EPIC® H-A 3/4
 600 V EPIC® H-A 10-48
 CSA: 600 V EPIC® H-A 3-48
 SEV: 400 V EPIC® H-A 3-48
- Bemessungsstrom: VDE: 10 A EPIC® H-A 3/4
 16 A EPIC® H-A 10-48
 UL: 10 A EPIC® H-A 3/4
 14 A EPIC® H-A 10-48
 CSA: 10/16 A EPIC® H-A 3/4
 20 A EPIC® H-A 10-48
 SEV: 16 A EPIC® H-A 3-48
- Verschmutzungsgrad: 3
- Prüfspannung: 4 kV
- Leitungsanschluß: Schraubanschluß: 0,5-2,5 mm²
- Temperaturbereich: -40°C - 125°C
- Kontakte: Kupferlegierung, hartversilbert
- Durchgangswiderstand: . . . 1,5-4 mOhm

Technical Data:

- Number of contacts: 3, 4, 10, 16, 32, 48 (+ PE)
- Rated voltage: VDE: 250 V EPIC® H-A 3-48
 UL: 250 V EPIC® H-A 3/4
 600 V EPIC® H-A 10-48
 CSA: 600 V EPIC® H-A 3-48
 SEV: 400 V EPIC® H-A 3-48
- Rated current: VDE: 10 A EPIC® H-A 3/4
 16 A EPIC® H-A 10-48
 UL: 10 A EPIC® H-A 3/4
 14 A EPIC® H-A 10-48
 CSA: 10/16 A EPIC® H-A 3/4
 20 A EPIC® H-A 10-48
 SEV: 16 A EPIC® H-A 3-48
- Pollution level: 3
- Test voltage: 4 kV
- Termination technique: Screw termination: 0,5-2,5 mm²
- Temperature range: -40°C - 125°C
- Contacts: Copper alloy, silver plated
- Contact resistance: 1,5-4 mOhm

Caractéristiques techniques:

- Nombre de contacts: 3, 4, 10, 16, 32, 48 (+ PE)
- Tension nominale: VDE: 250 V EPIC® H-A 3-48
 UL: 250 V EPIC® H-A 3/4
 600 V EPIC® H-A 10-48
 CSA: 600 V EPIC® H-A 3-48
 SEV: 400 V EPIC® H-A 3-48
- Courant nominale: VDE: 10 A EPIC® H-A 3/4
 16 A EPIC® H-A 10-48
 UL: 10 A EPIC® H-A 3/4
 14 A EPIC® H-A 10-48
 CSA: 10/16 A EPIC® H-A 3/4
 20 A EPIC® H-A 10-48
 SEV: 16 A EPIC® H-A 3-48
- Degré de pollution: 3
- Tension d'essai: 4 kV
- Raccordement: Raccord à visser: 0,5-2,5 mm²
- Gamme de température: . . . -40°C - 125°C
- Contacts: Alliage cuivre, argenté
- Résistance de passage: . . . 1,5-4 mOhm

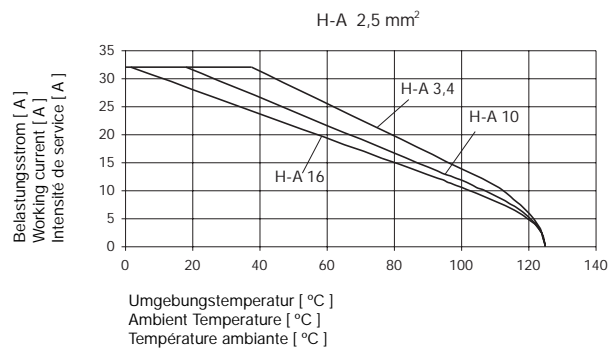
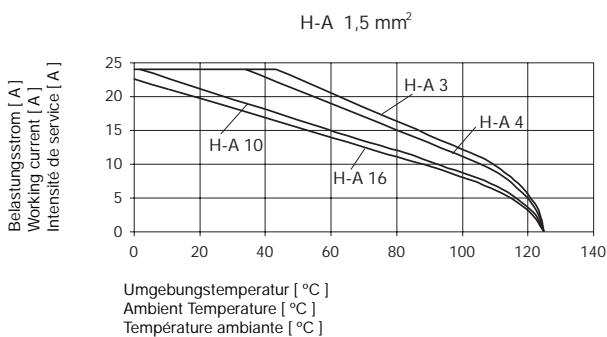

1.1 EPIC® H - A

Einsätze / Inserts / Inserts

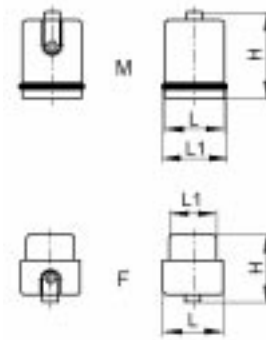

H-A 3

Artikel <i>part article</i>	Version <i>version version</i>	Art.Nr. <i>part No. N° art.</i>	Drahtschutz <i>wire protection protection de fil</i>	Kontakte <i>contacts contacts</i>	L	L1	H
H-A 3 SS	Stift / <i>male / mâle</i>	10420000*		3	21	23,3	26,3
H-A 3 BS	Buchse / <i>female / femelle</i>	10421000*		3	21	14,0	25,5

Gehäuse / *Housings / Boîtiers:*
3.1: H-A 3

Ansicht anschlußseitig
*View from cable side
Vue côté raccordement*

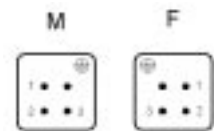

H-A 4

Artikel <i>part article</i>	Version <i>version version</i>	Art.Nr. <i>part No. N° art.</i>	Drahtschutz <i>wire protection protection de fil</i>	Kontakte <i>contacts contacts</i>	L	L1	H
H-A 4 SS	Stift / <i>male / mâle</i>	10431000*		4	21	23,6	32,5
H-A 4 BS	Buchse / <i>female / femelle</i>	10432000*		4	21	16,7	31,8

Gehäuse / *Housings / Boîtiers:*
3.1: H-A 3

Ansicht anschlußseitig
*View from cable side
Vue côté raccordement*

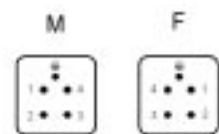

1.1 EPIC® H - A

Einsätze / Inserts / Inserts

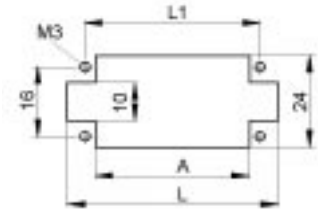
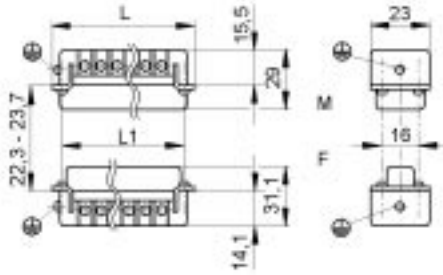

Montageausschnitt
Panel cut-out
Découpe de montage

H-A 10

Artikel part article	Version version version	Art.Nr. part No. N° art.	Drahtschutz wire protection protection de fil	Kontakte contacts contacts	L	L1	A
H-A 10 SS	Stift / male / mâle	10440100*	●	10	56,5	49,5	42,5
H-A 10 BS	Buchse / female / femelle	10441100*	●	10	56,5	49,5	42,5
H-A 10 SS	Stift / male / mâle	10440000*		10	56,5	49,5	42,5
H-A 10 BS	Buchse / female / femelle	10441000*		10	56,5	49,5	42,5

Gehäuse / Housings / Boîtiers:
3.1: H-A 10

Ansicht anschlußseitig
View from cable side
Vue côté raccordement

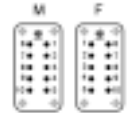

H-A 16

Artikel part article	Version version version	Art.Nr. part No. N° art.	Drahtschutz wire protection protection de fil	Kontakte contacts contacts	L	L1	A
H-A 16 SS	Stift / male / mâle	10530000*	●	16	73	66	60
H-A 16 BS	Buchse / female / femelle	10531000*	●	16	73	66	60
H-A 16 SS	Stift / male / mâle	10532000*		16	73	66	60
H-A 16 BS	Buchse / female / femelle	10533000*		16	73	66	60

Gehäuse / Housings / Boîtiers:
3.1: H-A 16

Ansicht anschlußseitig
View from cable side
Vue côté raccordement

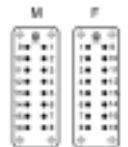

1.1 EPIC® H - A



Einsätze / Inserts / Inserts

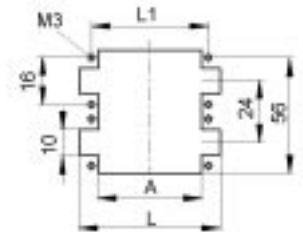
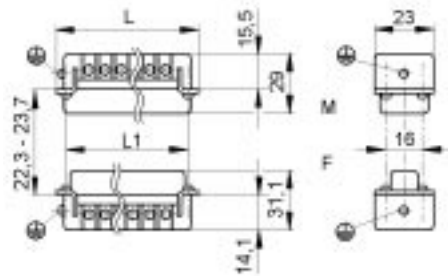

Montageausschnitt
Panel cut-out
Découpe de montage

H-A 32

Artikel part article	Version version version	Art.Nr. part No. N° art.	Drahtschutz wire protection protection de fil	Kontakte contacts contacts	L	L1	A
H-A 16 SS	1-16	10530000*	●	32	73	66	60
H-A 16 SS	17-32	10540000*	●		73	66	60
H-A 16 BS	1-16	10531000*	●	32	73	66	60
H-A 16 BS	17-32	10541000*	●		73	66	60
H-A 16 SS	1-16	10532000*		32	73	66	60
H-A 16 SS	17-32	10542000*			73	66	60
H-A 16 BS	1-16	10533000*		32	73	66	60
H-A 16 BS	17-32	10543000*			73	66	60

Gehäuse / Housings / Boîtiers:
3.1: H-A 32

Ansicht anschlußseitig
View from cable side
Vue côté raccordement



Montageausschnitt
Panel cut-out
Découpe de montage

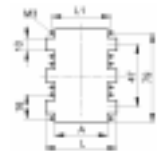

H-A 48

Artikel part article	Version version version	Art.Nr. part No. N° art.	Drahtschutz wire protection protection de fil	Kontakte contacts contacts	L	L1	A
H-A 16 SS	1-16	10530000*	●	48	73	66	60
H-A 16 SS	17-32	10540000*	●		73	66	60
H-A 16 SS	33-48	10540100	●		73	66	60
H-A 16 BS	1-16	10531000*	●	48	73	66	60
H-A 16 BS	17-32	10541000*	●		73	66	60
H-A 16 BS	33-48	10541100	●		73	66	60
H-A 16 SS	1-16	10532000*		48	73	66	60
H-A 16 SS	17-32	10542000*			73	66	60
H-A 16 SS	33-48	10542100			73	66	60
H-A 16 BS	1-16	10533000*		48	73	66	60
H-A 16 BS	17-32	10543000*			73	66	60
H-A 16 BS	33-48	10543100			73	66	60

Gehäuse / Housings / Boîtiers:
3.1: H-A 48

Ansicht anschlußseitig
View from cable side
Vue côté raccordement



1.2 EPIC® S T A

Einsätze / Inserts / Inserts

Der millionenfach bewährte Steckverbinder mit den soliden Kontaktfedern findet im Gerätebau, in Steuerungsanlagen und Labors, sowie in der Einschubtechnik große Verwendung. Die Einsätze sind in Schraubanschluß- und Lötanschlußtechnik erhältlich.

The connectors proven in a million applications with solid spring-designed contacts are used extensively in the construction of devices, in control units, laboratories and withdrawable-unit design.

Easy-mount inserts which are available with screw and solder connection.

Le connecteur des millions de fois testé, aux solides inserts à lamelles de contact, sont largement utilisés dans la construction d'appareils, dans les installations de contrôle, de commande dans les laboratoires, ainsi que dans les systèmes de tiroirs ou unités amovibles. Des connecteurs faciles à monter, qui sont disponibles en version à visser ou à souder.



1.2 EPIC® S T A

Einsätze / Inserts / Inserts

Technische Daten:

- Kontaktzahlen: 6, 14, 20
- Bemessungsspannung: VDE: 60 V EPIC® STA 6-20
UL: 48 V EPIC® STA 6-20
CSA: 48 V EPIC® STA 6-20
- Bemessungsstrom: VDE: 10 A EPIC® STA 6-20
UL: 10 A EPIC® STA 6-20
CSA: 10 A EPIC® STA 6-20
- Verschmutzungsgrad: 2
- Prüfpannung: 1,5 kV
- Leitungsanschluß: Lötanschluß: bis 1,5 mm²
Schraubanschluß: 0,5-1,5 mm²
- Temperaturbereich: -40°C - 80°C
- Kontakte: Kupferlegierung, hartversilbert
- Durchgangswiderstand: < 2 mOhm

Technical Data:

- Number of contacts: 6, 14, 20
- Rated voltage: VDE: 60 V EPIC® STA 6-20
UL: 48 V EPIC® STA 6-20
CSA: 48 V EPIC® STA 6-20
- Rated current: VDE: 10 A EPIC® STA 6-20
UL: 10 A EPIC® STA 6-20
CSA: 10 A EPIC® STA 6-20
- Pollution level: 2
- Test voltage: 1,5 kV
- Termination technique: Solder termination: up to 1,5 mm²
Screw termination: 0,5-1,5 mm²
- Temperature range: -40°C - 80°C
- Contacts: Copper alloy, silver plated
- Contact resistance: < 2 mOhm

Caractéristiques techniques:

- Nombre de contacts: 6, 14, 20
- Tension nominale: VDE: 60 V EPIC® STA 6-20
UL: 48 V EPIC® STA 6-20
CSA: 48 V EPIC® STA 6-20
- Courant nominale: VDE: 10 A EPIC® STA 6-20
UL: 10 A EPIC® STA 6-20
CSA: 10 A EPIC® STA 6-20
- Degré de pollution: 2
- Tension d'essai: 1,5 kV
- Raccordement: Raccord à souder: 1,5 mm² maxi
Raccord à visser: 0,5-1,5 mm²
- Gamme de température: -40°C - 80°C
- Contacts: Alliage cuivre, argenté
- Résistance de passage: < 2 mOhm

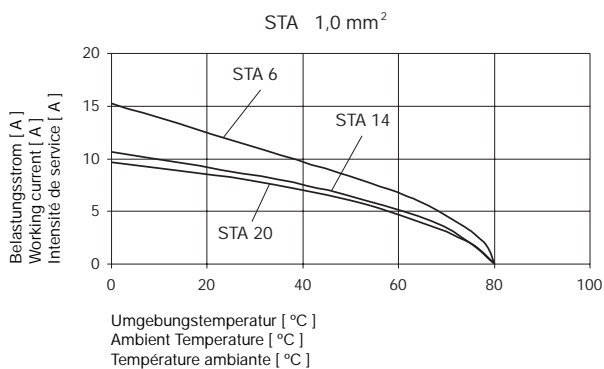

1.2 EPIC® S T A

Einsätze / Inserts / Inserts

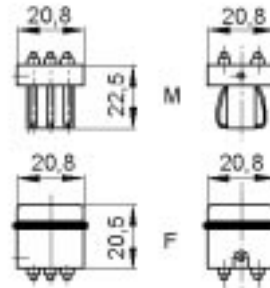

Schraubanschluß / Screw termination / Raccord à visser

STA 6

Artikel <i>part</i> <i>article</i>	Version <i>version</i> <i>version</i>	Art.Nr. <i>part No.</i> <i>N° art.</i>	Kontakte <i>contacts</i> <i>contacts</i>	L	L1	A
STA 6 FS	Stift / <i>male</i> / <i>mâle</i>	10488100*	6			
STA 6 SS	Buchse / <i>female</i> / <i>femelle</i>	10486100*	6			

Gehäuse / *Housings* / *Boîtiers*:
3.1: H-A 3

Ansicht anschlußseitig
View from cable side
Vue côté raccordement

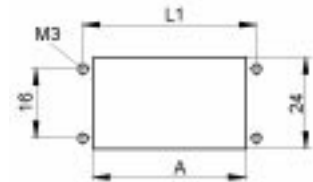
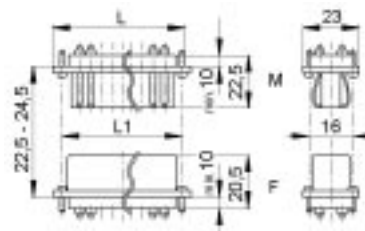

Montageausschnitt
Panel cut-out
Découpe de montage

STA 14

Artikel <i>part</i> <i>article</i>	Version <i>version</i> <i>version</i>	Art.Nr. <i>part No.</i> <i>N° art.</i>	Kontakte <i>contacts</i> <i>contacts</i>	L	L1	A
STA 14 FS	Stift / <i>male</i> / <i>mâle</i>	10493100*	14	56,5	49,5	41,5
STA 14 SS	Buchse / <i>female</i> / <i>femelle</i>	10491100*	14	56,5	49,5	41,5

Gehäuse / *Housings* / *Boîtiers*:
3.1: H-A 10

Ansicht anschlußseitig
View from cable side
Vue côté raccordement

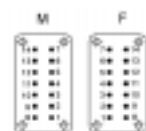

STA 20

Artikel <i>part</i> <i>article</i>	Version <i>version</i> <i>version</i>	Art.Nr. <i>part No.</i> <i>N° art.</i>	Kontakte <i>contacts</i> <i>contacts</i>	L	L1	A
STA 20 FS	Stift / <i>male</i> / <i>mâle</i>	10503100*	20	73	66	58
STA 20 SS	Buchse / <i>female</i> / <i>femelle</i>	10501100*	20	73	66	58

Gehäuse / *Housings* / *Boîtiers*:
3.1: H-A 16

Ansicht anschlußseitig
View from cable side
Vue côté raccordement

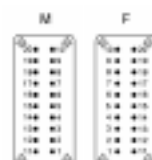

1.2 EPIC® S T A

Einsätze / Inserts / Inserts

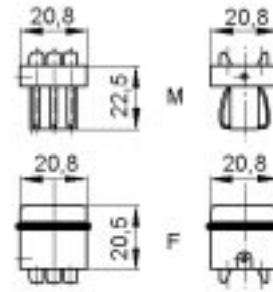

Lötanschluß / Solder termination / Raccord à souder

STA 6

Artikel <i>part</i> <i>article</i>	Version <i>version</i> <i>version</i>	Art.Nr. <i>part No.</i> <i>N° art.</i>	Kontakte <i>contacts</i> <i>contacts</i>	L	L1	A
STA 6 FL	Stift / <i>male</i> / <i>mâle</i>	10487200*	6			
STA 6 SL	Buchse / <i>female</i> / <i>femelle</i>	10485200*	6			

Gehäuse / *Housings* / *Boîtiers*:
3.1: H-A 3

Ansicht anschlußseitig
View from cable side
Vue côté raccordement

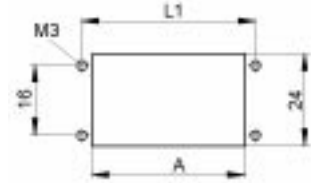
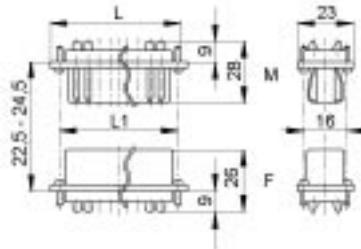

Montageausschnitt
Panel cut-out
Découpe de montage

STA 14

Artikel <i>part</i> <i>article</i>	Version <i>version</i> <i>version</i>	Art.Nr. <i>part No.</i> <i>N° art.</i>	Kontakte <i>contacts</i> <i>contacts</i>	L	L1	A
STA 14 FL	Stift / <i>male</i> / <i>mâle</i>	10492200*	14	56,5	49,5	41,5
STA 14 SL	Buchse / <i>female</i> / <i>femelle</i>	10490200*	14	56,5	49,5	41,5

Gehäuse / *Housings* / *Boîtiers*:
3.1: H-A 10

Ansicht anschlußseitig
View from cable side
Vue côté raccordement

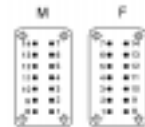

STA 20

Artikel <i>part</i> <i>article</i>	Version <i>version</i> <i>version</i>	Art.Nr. <i>part No.</i> <i>N° art.</i>	Kontakte <i>contacts</i> <i>contacts</i>	L	L1	A
STA 20 FL	Stift / <i>male</i> / <i>mâle</i>	10502200*	20	73	66	58
STA 20 SL	Buchse / <i>female</i> / <i>femelle</i>	10500200*	20	73	66	58

Gehäuse / *Housings* / *Boîtiers*:
3.1: H-A 16

Ansicht anschlußseitig
View from cable side
Vue côté raccordement

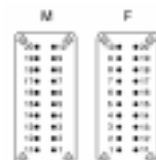

1.3 EPIC® H - B E

Einsätze / Inserts / Inserts

Die Einsatzmöglichkeit bei höheren Spannungen und Stromstärken, sowie eine hohe Zuverlässigkeit zeichnet die bewährte EPIC® H-BE Serie in 6 – 48 poliger Ausführung aus. Die Verdrahtung der Einsätze erfolgt mit einem Schraubanschluß, Crimpanschluß oder Käfigzugfederanschluß.

The characteristic qualities of the proven EPIC® H-BE series in 6 - 48 contacts version are their suitability for applications with high voltages and current as well as their high reliability and safety. The inserts are wired by means of a screw, crimp or cage clamp termination.

Les caractéristiques reconnues de la série EPIC® H-BE de 6 à 48 contacts sont l'utilisation pour des tensions et courants élevés avec une fiabilité et une sécurité accrue. Le câblage des connecteurs existe en raccord à visser, raccords à sertis ou lame de pression.

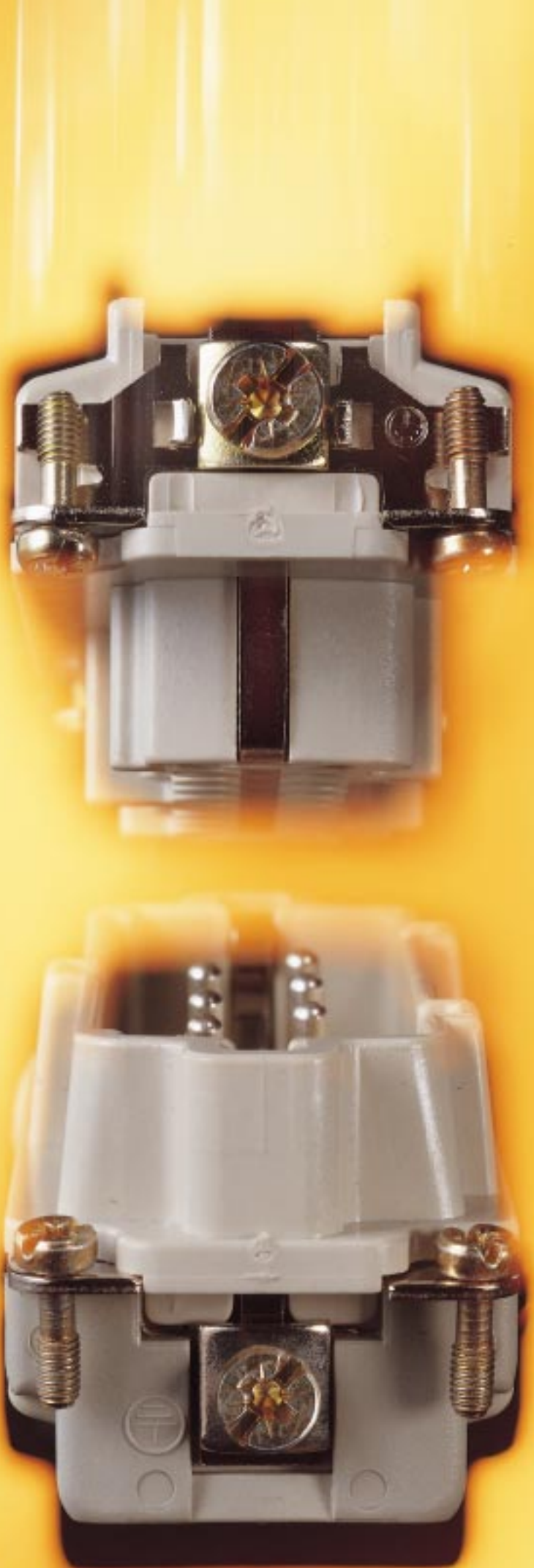

1.3 EPIC® H - B E

Einsätze / Inserts / Inserts

Technische Daten:

- Kontaktzahlen: 6, 10, 16, 24, 32, 48 (+ PE)

Schraubanschluß / Crimpanschluß:

- Bemessungsspannung: VDE: 400 V EPIC® H-BE 6-48
UL: 600 V EPIC® H-BE 6-48
CSA: 600 V EPIC® H-BE 6-48
SEV: 400 V EPIC® H-BE 6-48
- Bemessungsstrom: VDE: 16 A EPIC® H-BE 6-48
UL: 16 A EPIC® H-BE 6-48
CSA: 10 A EPIC® H-BE 6-48
SEV: 16 A EPIC® H-BE 6-48

Käfigzugfederanschluß:

- Bemessungsspannung: VDE: 500 V EPIC® H-BE 6-48
UL: 600 V EPIC® H-BE 6-48
CSA: 600 V EPIC® H-BE 6-48
- Bemessungsstrom: VDE: 16 A EPIC® H-BE 6-48
UL: 16 A EPIC® H-BE 6-48
CSA: 16 A EPIC® H-BE 6-48
- Verschmutzungsgrad: 3
- Prüfspannung: 6kV

Anschlußtechnik:

- Schraubanschluß: 0,5-2,5 mm²
- Crimpanschluß: 0,5-4 mm²
- Käfigzugfederanschluß: 0,5-2,5 mm²
- Temperaturbereich: -40°C - 125°C

Kontakte:

- Schraubanschluß: Kupferlegierung - hartversilbert
- Crimpanschluß: Kupferlegierung -
hartversilbert/hartvergoldet
- Käfigzugfederanschluß: Kupferlegierung - hartversilbert

Durchgangswiderstand:

- Schraubanschluß: <2 mOhm
- Crimpanschluß: <2 mOhm
- Käfigzugfederanschluß: 1,5-4 m Ohm

Technical Data:

- Number of contacts: 6, 10, 16, 24, 32, 48 (+ PE)

Screw Termination/Crimp termination

- Rated voltage: VDE: 400 V EPIC® H-BE 6-48
UL: 600 V EPIC® H-BE 6-48
CSA: 600 V EPIC® H-BE 6-48
SEV: 400 V EPIC® H-BE 6-48
- Rated current: VDE: 16 A EPIC® H-BE 6-48
UL: 16 A EPIC® H-BE 6-48
CSA: 10 A EPIC® H-BE 6-48
SEV: 16 A EPIC® H-BE 6-48

Cage clamp:

- Rated voltage: VDE: 500 V EPIC® H-BE 6-48
UL: 600 V EPIC® H-BE 6-48
CSA: 600 V EPIC® H-BE 6-48
- Rated current: VDE: 16 A EPIC® H-BE 6-48
UL: 16 A EPIC® H-BE 6-48
CSA: 16 A EPIC® H-BE 6-48
- Pollution level: 3
- Test voltage: 6 kV

Termination technique:

- Screw termination: 0,5-2,5 mm²
- Crimp termination: 0,5-4,0 mm²
- Cage clamp termination: 0,5-2,5 mm²
- Temperature range: -40°C - 125°C

Contacts:

- Screw termination: Copper alloy, silver plated
- Crimp termination: Copper alloy, silver plated/
gold plated
- Cage Clamp termination: Copper alloy, silver plated

Contact resistance:

- Screw termination: <2 mOhm
- Crimp termination: <2 mOhm
- Cage Clamp termination: 1,5 - 4 mOhm

Caractéristiques techniques:

Raccord à visser/Raccord à souder

- Nombre de contacts: 6, 10, 16, 24, 32, 48 (+ PE)
- Tension nominale: VDE: 400 V EPIC® H-BE 6-48
UL: 600 V EPIC® H-BE 6-48
CSA: 600 V EPIC® H-BE 6-48
SEV: 400 V EPIC® H-BE 6-48
- Courant nominale: VDE: 16 A EPIC® H-BE 6-48
UL: 16 A EPIC® H-BE 6-48
CSA: 10 A EPIC® H-BE 6-48
SEV: 16 A EPIC® H-BE 6-48

Raccord lame de pression

- Tension nominale: VDE: 500 V EPIC® H-BE 6-48
UL: 600 V EPIC® H-BE 6-48
CSA: 600 V EPIC® H-BE 6-48
- Courant nominale: VDE: 16 A EPIC® H-BE 6-48
UL: 16 A EPIC® H-BE 6-48
CSA: 16 A EPIC® H-BE 6-48
- Degré de pollution: 3
- Tension d'essai: 6 kV

Raccordement:

- Raccord à visser: 0,5-2,5 mm²
- Raccord à sertir: 0,5-4 mm²
- Raccord lame de pression: ... 0,5-2,5 mm²
- Gamme de température: -40°C - 125°C

Contacts:

- Raccord à vis: Alliage cuivre, argenté
- Raccord à sertir: Alliage cuivre, argenté/doré
- Raccord lame de pression: ... Alliage cuivre, argenté

Résistance de passage:

- Raccord à visser: < 2 mOhm
- Raccord à sertir: < 2 mOhm
- Raccord lame de pression: ... 1,5 - 4 mOhm

1.3 EPIC® H - B E

Einsätze / Inserts / Inserts

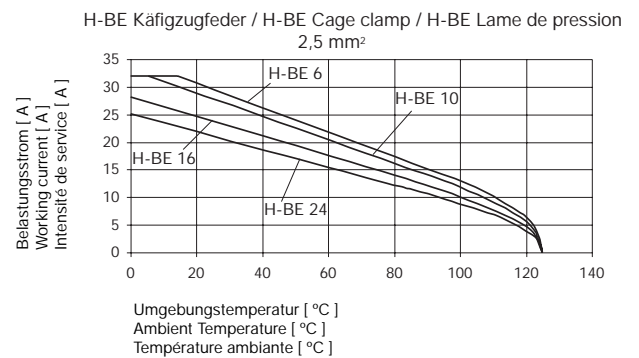
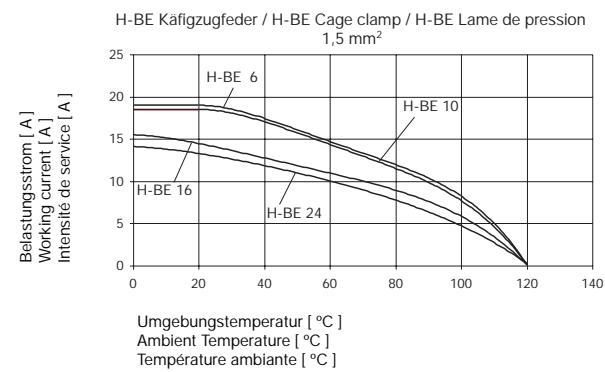
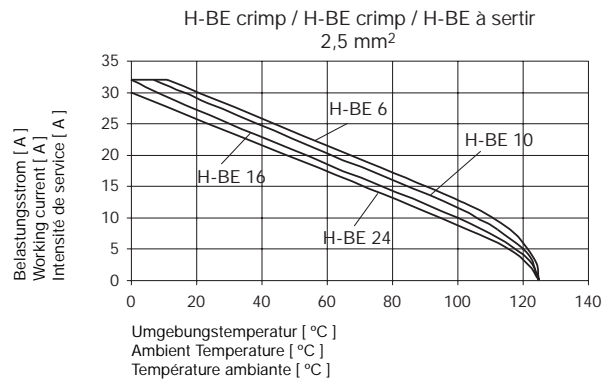
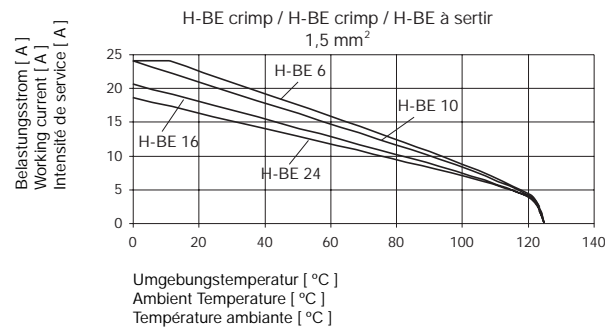
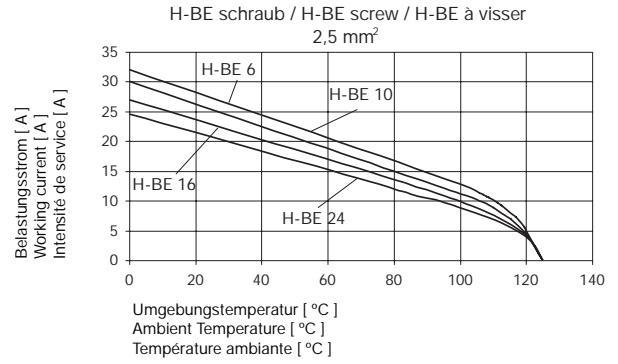
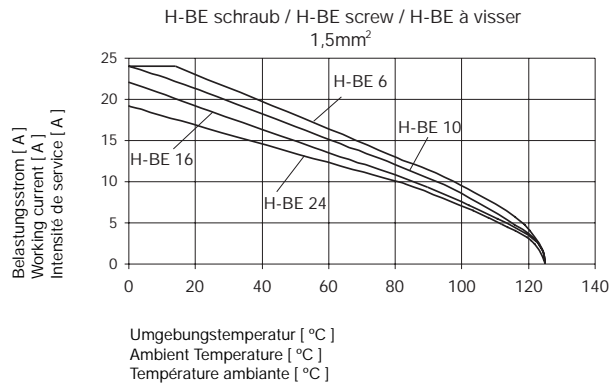

1.3 EPIC® H - B E

Einsätze / Inserts / Inserts

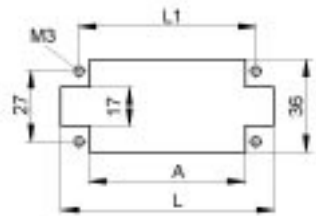
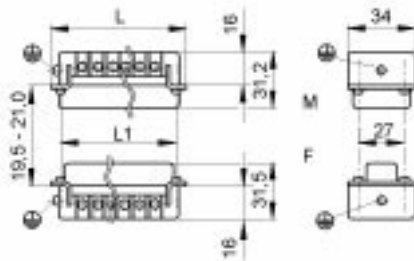

Montageausschnitt
Panel cut-out
Découpe de montage

Schraubanschluß / Screw termination / Raccord à visser

H-BE 6

Artikel part article	Version version version	Art.Nr. part No. N° art.	Drahtschutz wire protection protection de fil	Kontakte contacts contacts	L	L1	A
H-BE 6 SS	Stift / male / mâle	10190000*	●	6	51	44	39
H-BE 6 BS	Buchse / female / femelle	10191000*	●	6	51	44	39
H-BE 6 SS	Stift / male / mâle	10190100*		6	51	44	39
H-BE 6 BS	Buchse / female / femelle	10191100*		6	51	44	39

Gehäuse / Housings / Boîtiers:
3.2: H-B 6

Ansicht anschlußseitig
View from cable side
Vue côté raccordement



H-BE 10

Artikel part article	Version version version	Art.Nr. part No. N° art.	Drahtschutz wire protection protection de fil	Kontakte contacts contacts	L	L1	A
H-BE 10 SS	Stift / male / mâle	10192000*	●	10	64	57	52
H-BE 10 BS	Buchse / female / femelle	10193000*	●	10	64	57	52
H-BE 10 SS	Stift / male / mâle	10192100*		10	64	57	52
H-BE 10 BS	Buchse / female / femelle	10193100*		10	64	57	52

Gehäuse / Housings / Boîtiers:
3.2: H-B 10

Ansicht anschlußseitig
View from cable side
Vue côté raccordement

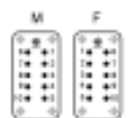

H-BE 16

Artikel part article	Version version version	Art.Nr. part No. N° art.	Drahtschutz wire protection protection de fil	Kontakte contacts contacts	L	L1	A
H-BE 16 SS	Stift / male / mâle	10194000*	●	16	84,5	77,5	71
H-BE 16 BS	Buchse / female / femelle	10195000*	●	16	84,5	77,5	71
H-BE 16 SS	Stift / male / mâle	10194100*		16	84,5	77,5	71
H-BE 16 BS	Buchse / female / femelle	10195100*		16	84,5	77,5	71

Gehäuse / Housings / Boîtiers:
3.2: H-B 16

Ansicht anschlußseitig
View from cable side
Vue côté raccordement

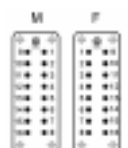

1.3 EPIC® H - B E

Einsätze / Inserts / Inserts

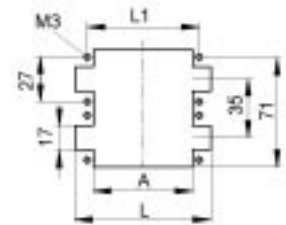
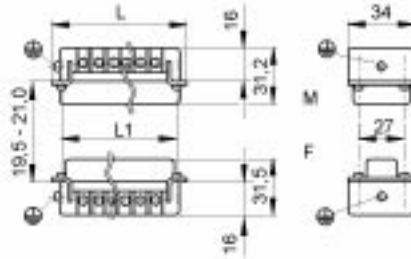

Montageausschnitt
Panel cut-out
Découpe de montage

Schraubanschluß / Screw termination / Raccord à visser

H-BE 24

Artikel <i>part</i> <i>article</i>	Version <i>version</i> <i>version</i>	Art.Nr. <i>part No.</i> <i>N° art.</i>	Drahtschutz <i>wire protection</i> <i>protection de fil</i>	Kontakte <i>contacts</i> <i>contacts</i>	L	L1	A
H-BE 24 SS	Stift / <i>male</i> / <i>mâle</i>	10196000*	●	24	111	104	98
H-BE 24 BS	Buchse / <i>female</i> / <i>femelle</i>	10197000*	●	24	111	104	98
H-BE 24 SS	Stift / <i>male</i> / <i>mâle</i>	10196100*		24	111	104	98
H-BE 24 BS	Buchse / <i>female</i> / <i>femelle</i>	10197100*		24	111	104	98

Gehäuse / *Housings* / *Boîtiers*: 3.2: H-B 24
Montageausschnitt siehe vorherige Seite / *Panel cut out see previous page* / *Découpe de montage voir page précédente*

Ansicht anschlußseitig
View from cable side
Vue côté raccordement

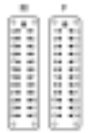

H-BE 32

Artikel <i>part</i> <i>article</i>	Version <i>version</i> <i>version</i>	Art.Nr. <i>part No.</i> <i>N° art.</i>	Drahtschutz <i>wire protection</i> <i>protection de fil</i>	Kontakte <i>contacts</i> <i>contacts</i>	L	L1	A
H-BE 16 SS 1-16	Stift / <i>male</i> / <i>mâle</i>	10194000*	●	32	84,5	77,5	71
H-BE 16 SS 17-32		10202000*	●		84,5	77,5	71
H-BE 16 BS 1-16	Buchse / <i>female</i> / <i>femelle</i>	10195000*	●	32	84,5	77,5	71
H-BE 16 BS 17-32		10203000*	●		84,5	77,5	71
H-BE 16 SS 1-16	Stift / <i>male</i> / <i>mâle</i>	10194100*		32	84,5	77,5	71
H-BE 16 SS 17-32		10202100*			84,5	77,5	71
H-BE 16 BS 1-16	Buchse / <i>female</i> / <i>femelle</i>	10195100*		32	84,5	77,5	71
H-BE 16 BS 17-32		10203100*			84,5	77,5	71

Gehäuse / *Housings* / *Boîtiers*:
3.2: H-B 32

Ansicht anschlußseitig
View from cable side
Vue côté raccordement

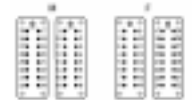

H-BE 48

Artikel <i>part</i> <i>article</i>	Version <i>version</i> <i>version</i>	Art.Nr. <i>part No.</i> <i>N° art.</i>	Drahtschutz <i>wire protection</i> <i>protection de fil</i>	Kontakte <i>contacts</i> <i>contacts</i>	L	L1	A
H-BE 24 SS 1-24	Stift / <i>male</i> / <i>mâle</i>	10196000*	●	48	111	104	98
H-BE 24 SS 25-48		10204000*	●		111	104	98
H-BE 24 BS 1-24	Buchse / <i>female</i> / <i>femelle</i>	10197000*	●	48	111	104	98
H-BE 24 BS 25-48		10205000*	●		111	104	98
H-BE 24 SS 1-24	Stift / <i>male</i> / <i>mâle</i>	10196100*		48	111	104	98
H-BE 24 SS 25-48		10204100*			111	104	98
H-BE 24 BS 1-24	Buchse / <i>female</i> / <i>femelle</i>	10197100*		48	111	104	98
H-BE 24 BS 25-48		10205100*			111	104	98

Gehäuse / *Housings* / *Boîtiers*:
3.2: H-B 48

Ansicht anschlußseitig
View from cable side
Vue côté raccordement



1.3 EPIC® H - B E



Einsätze / Inserts / Inserts

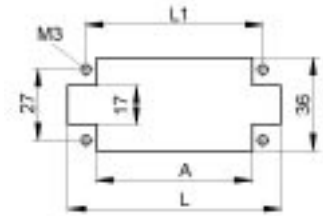
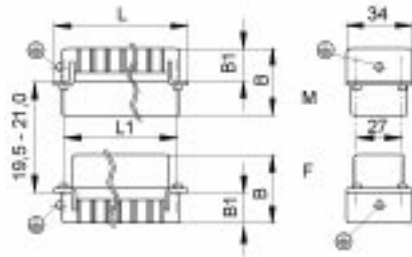

Montageausschnitt
Panel cut-out
Découpe de montage

Crimpschluß / Crimp termination / Raccord à sertir

H-BE 6

Artikel <i>part</i> <i>article</i>	Version <i>version</i> <i>version</i>	Art.Nr. <i>part No.</i> <i>N° art.</i>	Typ <i>type</i> <i>type</i>	Kontakte <i>contacts</i> <i>contacts</i>	L	L1	A	B	B1
H-BE 6 SCM	Stift / <i>male</i> / <i>mâle</i>	10180000*	gedreht / <i>machined</i> / <i>décolleté</i>	6	51	44	39	33	18
H-BE 6 BCM	Buchse / <i>female</i> / <i>femelle</i>	10181000*		6	51	44	39	34	18

Gehäuse / *Housings* / *Boîtiers*: 3.2: H-B 6
Kontakte / *Contacts* / *Contacts*: 2.1: H-BE 2,5 gedreht / *machined* / *décolleté*

Ansicht anschlußseitig
View from cable side
Vue côté raccordement



H-BE 10

Artikel <i>part</i> <i>article</i>	Version <i>version</i> <i>version</i>	Art.Nr. <i>part No.</i> <i>N° art.</i>	Typ <i>type</i> <i>type</i>	Kontakte <i>contacts</i> <i>contacts</i>	L	L1	A	B	B1
H-BE 10 SCM	Stift / <i>male</i> / <i>mâle</i>	10182000*	gedreht / <i>machined</i> / <i>décolleté</i>	10	64	57	52	33	18
H-BE 10 BCM	Buchse / <i>female</i> / <i>femelle</i>	10183000*		10	64	57	52	34	18

Gehäuse / *Housings* / *Boîtiers*: 3.2: H-B 10
Kontakte / *Contacts* / *Contacts*: 2.1: H-BE 2,5 gedreht / *machined* / *décolleté*

Ansicht anschlußseitig
View from cable side
Vue côté raccordement

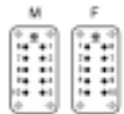

H-BE 16

Artikel <i>part</i> <i>article</i>	Version <i>version</i> <i>version</i>	Art.Nr. <i>part No.</i> <i>N° art.</i>	Typ <i>type</i> <i>type</i>	Kontakte <i>contacts</i> <i>contacts</i>	L	L1	A	B	B1
H-BE 16 SCM	Stift / <i>male</i> / <i>mâle</i>	10184000*	gedreht / <i>machined</i> / <i>décolleté</i>	16	84,5	77,5	71	33	18
H-BE 16 BCM	Buchse / <i>female</i> / <i>femelle</i>	10185000*		16	84,5	77,5	71	34	18

Gehäuse / *Housings* / *Boîtiers*: 3.2: H-B 16
Kontakte / *Contacts* / *Contacts*: 2.1: H-BE 2,5 gedreht / *machined* / *décolleté*

Ansicht anschlußseitig
View from cable side
Vue côté raccordement

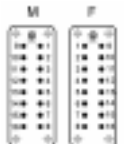

1.3 EPIC® H - B E



Einsätze / Inserts / Inserts

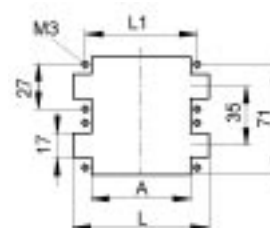
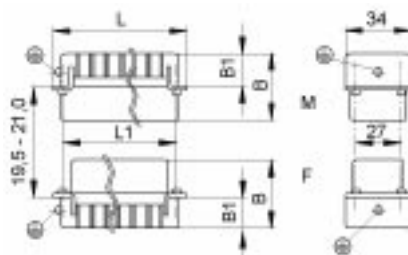

Montageausschnitt
Panel cut-out
Découpe de montage

Crimpanschluß / Crimp termination / Raccord à sertir

H-BE 24

Artikel <i>part</i> <i>article</i>	Version <i>version</i> <i>version</i>	Art.Nr. <i>part No.</i> <i>N° art.</i>	Typ <i>type</i> <i>type</i>	Kontakte <i>contacts</i> <i>contacts</i>	L	L1	A	B	B1
H-BE 24 SCM	Stift / <i>male</i> / <i>mâle</i>	10186000*	gedreht / <i>machined</i> / <i>décolleté</i>	24	111	104	98	33	18
H-BE 24 BCM	Buchse / <i>female</i> / <i>femelle</i>	10187000*		24	111	104	98	34	18

Gehäuse / *Housings* / *Boîtiers*: 3.2: H-B 24

Kontakte / *Contacts* / *Contacts*: 2.1: H-BE 2,5 gedreht / *machined* / *décolleté*

Montageausschnitt siehe vorherige Seite / *Panel cut-out see previous page* / *Découpe de montage voir page précédente*

Ansicht anschlußseitig
View from cable side
Vue côté raccordement



H-BE 32

Artikel <i>part</i> <i>article</i>	Version <i>version</i> <i>version</i>	Art.Nr. <i>part No.</i> <i>N° art.</i>	Typ <i>type</i> <i>type</i>	Kontakte <i>contacts</i> <i>contacts</i>	L	L1	A	B	B1
H-BE 16 SCM 1-16	Stift / <i>male</i> / <i>mâle</i>	10184000*	gedreht / <i>machined</i> / <i>décolleté</i>	32	84,5	77,5	71	33	18
H-BE 16 SCM 17-32	Stift / <i>male</i> / <i>mâle</i>	10184200			84,5	77,5	71	34	18
H-BE 16 BCM 1-16	Buchse / <i>female</i> / <i>femelle</i>	10185000*		32	84,5	77,5	71	33	18
H-BE 16 BCM 17-32	Buchse / <i>female</i> / <i>femelle</i>	10185200			84,5	77,5	71	34	18

Gehäuse / *Housings* / *Boîtiers*: 2.1: H-B 32

Kontakte / *Contacts* / *Contacts*: 3.2: H-BE 2,5 gedreht / *machined* / *décolleté*

Ansicht anschlußseitig
View from cable side
Vue côté raccordement



H-BE 48

Artikel <i>part</i> <i>article</i>	Version <i>version</i> <i>version</i>	Art.Nr. <i>part No.</i> <i>N° art.</i>	Typ <i>type</i> <i>type</i>	Kontakte <i>contacts</i> <i>contacts</i>	L	L1	A	B	B1
H-BE 24 SCM 1-24	Stift / <i>male</i> / <i>mâle</i>	10186000*	gedreht / <i>machined</i> / <i>décolleté</i>	48	111	104	98	33	18
H-BE 24 SCM 25-48	Stift / <i>male</i> / <i>mâle</i>	10186200			111	104	98	34	18
H-BE 24 BCM 1-24	Buchse / <i>female</i> / <i>femelle</i>	10187000*		48	111	104	98	33	18
H-BE 24 BCM 25-48	Buchse / <i>female</i> / <i>femelle</i>	10187200			111	104	98	34	18

Gehäuse / *Housings* / *Boîtiers*: 2.1: H-B 48

Kontakte / *Contacts* / *Contacts*: 3.2: H-BE 2,5 gedreht / *machined* / *décolleté*

Ansicht anschlußseitig
View from cable side
Vue côté raccordement



1.3 EPIC® H - B E

Einsätze / Inserts / Inserts

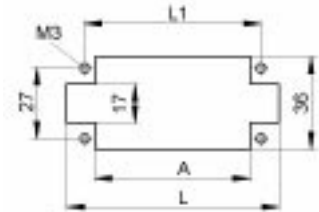
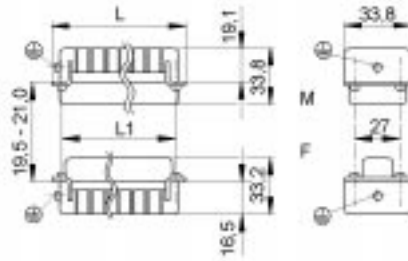
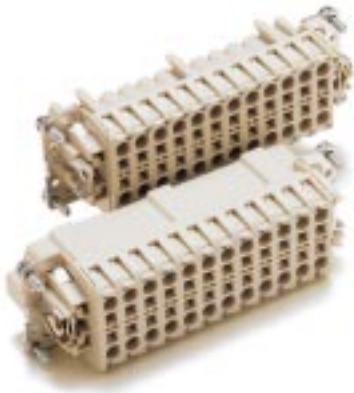

Montageausschnitt
Panel cut-out
Découpe de montage

Käfigzugfederanschluß / Cage clamp / Lame de pression

H-BE 6

Artikel / part / article	Version / version / version	Art.Nr. / part No. / N° art.	Kontakte / contacts / contacts	L	L1	A
H-BE 6 SF	Stift / male / mâle	10400000	6	49,8	44	39
H-BE 6 BF	Buchse / female / femelle	10401000	6	49,8	44	39

Gehäuse / Housings / Boîtiers:
3.2: H-B 6

Ansicht anschlußseitig
View from cable side
Vue côté raccordement



H-BE 10

Artikel / part / article	Version / version / version	Art.Nr. / part No. / N° art.	Kontakte / contacts / contacts	L	L1	A
H-BE 10 SF	Stift / male / mâle	10400100	10	62,8	57	52
H-BE 10 BF	Buchse / female / femelle	10401100	10	62,8	57	52

Gehäuse / Housings / Boîtiers:
3.2: H-B 10

Ansicht anschlußseitig
View from cable side
Vue côté raccordement

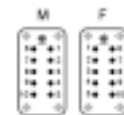

H-BE 16

Artikel / part / article	Version / version / version	Art.Nr. / part No. / N° art.	Kontakte / contacts / contacts	L	L1	A
H-BE 16 SF	Stift / male / mâle	10400200	16	83,3	77,5	71
H-BE 16 BF	Buchse / female / femelle	10401200	16	83,3	77,5	71

Gehäuse / Housings / Boîtiers:
3.2: H-B 16

Ansicht anschlußseitig
View from cable side
Vue côté raccordement

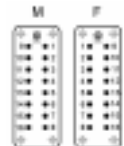

H-BE 24

Artikel / part / article	Version / version / version	Art.Nr. / part No. / N° art.	Kontakte / contacts / contacts	L	L1	A
H-BE 24 SF	Stift / male / mâle	10400300	24	109,8	104	98
H-BE 24 BF	Buchse / female / femelle	10401300	24	109,8	104	98

Gehäuse / Housings / Boîtiers:
3.2: H-B 24

Ansicht anschlußseitig
View from cable side
Vue côté raccordement



1.3 EPIC® H - B E

Einsätze / Inserts / Inserts

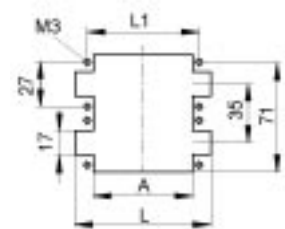
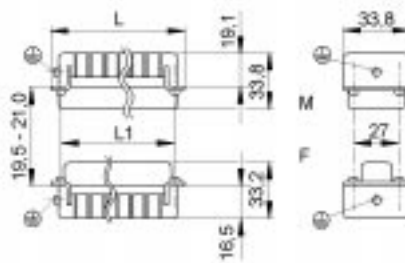
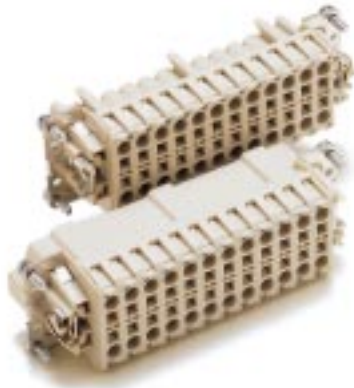

Montageausschnitt
Panel cut-out
Découpe de montage

Käfigzugfederanschluß / Cage clamp / Lame de pression

H-BE 32

Artikel / part / article	Version / version / version	Art.Nr. / part No. / N° art.	Kontakte / contacts / contacts	L	L1	A
H-BE 16 SF 1-16	Stift / male / mâle	10400200	32	83,3	77,5	71
H-BE 16 SF 17-32		10400400		83,3	77,5	71
H-BE 16 BF 1-16	Buchse / female / femelle	10401200	32	83,3	77,5	71
H-BE 16 BF 17-32		10401400		83,3	77,5	71

Gehäuse / Housings / Boîtiers:
3.2: H-B 32

Ansicht anschlußseitig
View from cable side
Vue côté raccordement

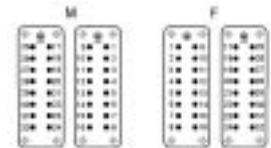

H-BE 48

Artikel / part / article	Version / version / version	Art.Nr. / part No. / N° art.	Kontakte / contacts / contacts	L	L1	A
H-BE 24 SF 1-24	Stift / male / mâle	10400300	48	109,8	104	98
H-BE 24 SF 25-48		10400500		109,8	104	98
H-BE 24 BF 1-24	Buchse / female / femelle	10401300	48	109,8	104	98
H-BE 24 BF 25-48		10401500		109,8	104	98

Gehäuse / Housings / Boîtiers:
3.2: H-B 48

Ansicht anschlußseitig
View from cable side
Vue côté raccordement

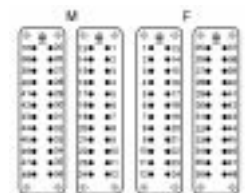

1.4 EPIC® H - B S

Einsätze / Inserts / Inserts

Die Einsätze der EPIC® H-BS Serie sind durch eine hohe Strombelastbarkeit gekennzeichnet. Die einfache Montage durch Schraubanschluß bis 6 mm² Drahtquerschnitt führt zu einer sicheren und beständigen Verbindung

The characteristic quality of EPIC® H-BS inserts is their high current carrying capacity. Simple mounting by a screw terminal up to a cross-sectional area of 6 mm² provides a secure and resistant connection.

Les inserts de la série EPIC® H-BS se distinguent par une capacité élevée de charge en courant. Le montage aisé par raccord vissé jusqu'à 6 mm² de section de raccordement fournit une liaison sûre et durable.



1.4 EPIC® H - B S

Einsätze / Inserts / Inserts

Technische Daten:

- Kontaktzahlen: 6, 12 (+ PE)
- Bemessungsspannung: VDE: 400 V EPIC® H-BS 6/12
UL: 600 V EPIC® H-BS 6/12
CSA: 600 V EPIC® H-BS 6/12
SEV: 660 V EPIC® H-BS 6/12
- Bemessungsstrom: VDE: 35 A EPIC® H-BS 6/12
UL: 35 A EPIC® H-BS 6/12
CSA: 35 A EPIC® H-BS 6/12
SEV: 35 A EPIC® H-BS 6/12
- Verschmutzungsgrad: 3
- Prüfspannung: 6 kV
- Leitungsanschluß: Schraubanschluß: 0,5-6 mm²
- Temperaturbereich: -40°C - 125°C
- Kontakte: Kupferlegierung, hartversilbert
- Durchgangswiderstand: <2 mOhm

Technical Data:

- Number of contacts: 6, 12 (+ PE)
- Rated voltage: VDE: 400 V EPIC® H-BS 6/12
UL: 600 V EPIC® H-BS 6/12
CSA: 600 V EPIC® H-BS 6/12
SEV: 660 V EPIC® H-BS 6/12
- Rated current: VDE: 35 A EPIC® H-BS 6/12
UL: 35 A EPIC® H-BS 6/12
CSA: 35 A EPIC® H-BS 6/12
SEV: 35 A EPIC® H-BS 6/12
- Degré de pollution: 3
- Test voltage: 6 kV
- Termination technique: Screw termination: 0,5-6 mm²
- Temperature range: -40°C - 125°C
- Contacts: Copper alloy, silver plated
- Contact resistance: <2 mOhm

Caractéristiques techniques:

- Nombre de contacts: 6, 12 (+ PE)
- Tension nominale: VDE: 400 V EPIC® H-BS 6/12
UL: 600 V EPIC® H-BS 6/12
CSA: 600 V EPIC® H-BS 6/12
SEV: 660 V EPIC® H-BS 6/12
- Courant nominale: VDE: 35 A EPIC® H-BS 6/12
UL: 35 A EPIC® H-BS 6/12
CSA: 35 A EPIC® H-BS 6/12
SEV: 35 A EPIC® H-BS 6/12
- Degré de pollution: 3
- Tension d'essai: 6 kV
- Raccordement: Raccord à visser: 0,5-6 mm²
- Gamme de température: -40°C - 125°C
- Contacts: Alliage cuivre, argenté
- Résistance de passage: <2 mOhm

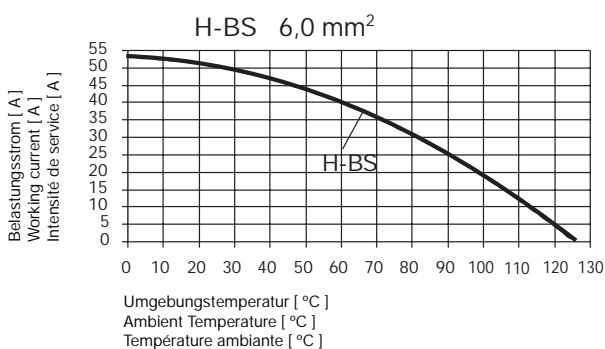

1.4 EPIC® H - B S

Einsätze / Inserts / Inserts

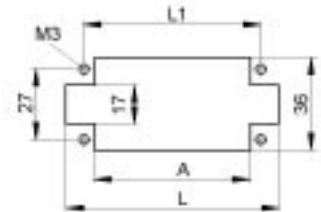
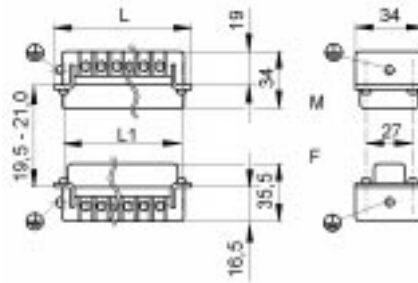

Montageausschnitt
Panel cut-out
Découpe de montage

H-BS 6

Artikel part article	Version version version	Art.Nr. part No. N° art.	Drahtschutz wire protection protection de fil	Kontakte contacts contacts	L	L1	A
H-BS 6 SS	Stift / male / mâle	10170000*	●	6	84,5	77,5	71
H-BS 6 BS	Buchse / female / femelle	10171000*	●	6	84,5	77,5	71

Gehäuse / Housings / Boîtiers:
3.2: H-B 16

Ansicht anschlussseitig
View from cable side
Vue côté raccordement

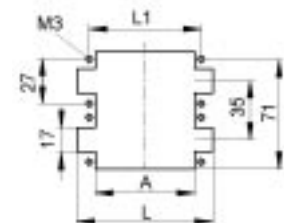
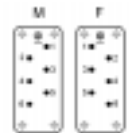

Montageausschnitt
Panel cut-out
Découpe de montage

H-BS 12

Artikel part article	Version version version	Art.Nr. part No. N° art.	Drahtschutz wire protection protection de fil	Kontakte contacts contacts	L	L1	A
H-BS 6 SS 1-6	Stift / male / mâle	10170000*	●	12	84,5	77,5	71
H-BS 6 SS 7-12		10170600*	●		84,5	77,5	71
H-BS 6 BS 1-6	Buchse / female / femelle	10171000*	●	12	84,5	77,5	71
H-BS 6 BS 7-12		10171600*	●		84,5	77,5	71

Gehäuse / Housings / Boîtiers:
3.2: H-B 32

Ansicht anschlussseitig
View from cable side
Vue côté raccordement

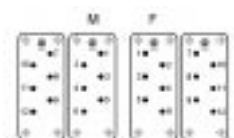

1.5 EPIC® H - B V E

Einsätze / Inserts / Inserts

Die Hochvolt-Einsätze der Baureihe H-BVE sind mit Schaltkontakten bestückt. Diese beim Stecken nachellenden Kontakte bewirken, daß kein Steckvorgang unter Spannung durchgeführt werden kann. Die Schaltkontakte unterbrechen die Stromversorgung zum System, bevor die Arbeitskontakte getrennt werden. Das führt zu mehr Sicherheit im praktischen Betrieb.

The high-volt inserts of series H-BVE are equipped with switch contacts. These contacts which lag when inserted, prevent insertion of the connectors when the system is live. The switching contacts interrupt the power supply to the system before the working contacts are separated. This means more safety when in operation.

Les inserts à tension élevée de la série H-BVE sont équipés de contacts de pré-coupure. Ces contacts à retard lors de l'enfichage ont pour effet qu'aucun enfichage ne peut être effectué sous tension. Les contacts de pré-coupure interrompent l'alimentation en courant du système avant que les contacts de travail ne soient séparés. Ceci signifie une sécurité accrue dans la pratique de tous les jours.

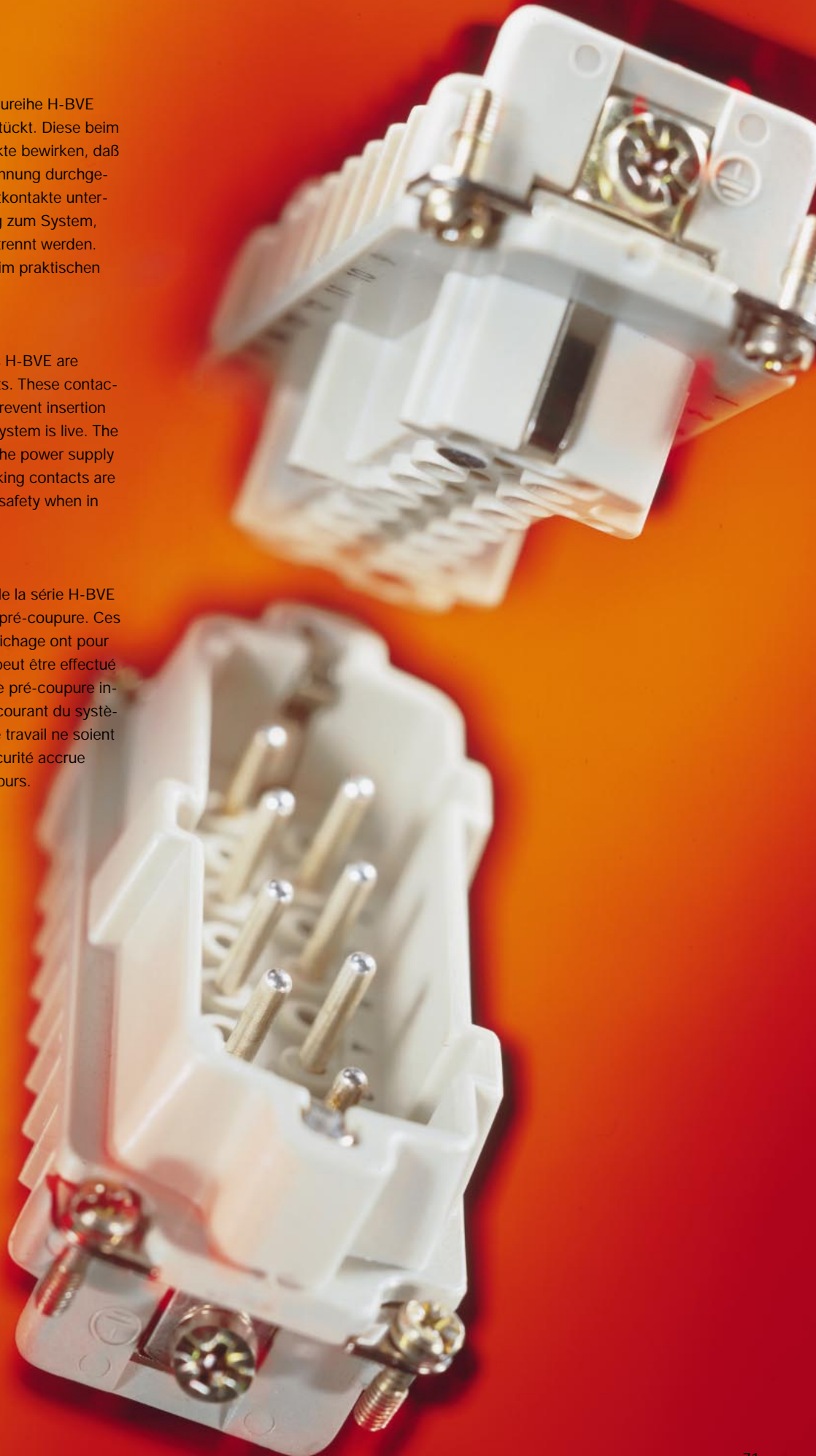

1.5 EPIC® H - B V E

Einsätze / Inserts / Inserts

Technische Daten:

- Kontaktzahlen: 3, 6, 10 (+ PE)
- Bemessungsspannung: VDE: 630 V EPIC® H-BVE 3-10
UL: 600 V EPIC® H-BVE 3-10
CSA: 600 V EPIC® H-BVE 3-10
SEV: 660 V EPIC® H-BVE 3-10
- Bemessungsstrom: VDE: 16 A EPIC® H-BVE 3-10
UL: 16 A EPIC® H-BVE 3-10
CSA: 16 A EPIC® H-BVE 3-10
SEV: 16 A EPIC® H-BVE 3-10
- Verschmutzungsgrad: 3
- Prüfspannung: 6 kV
- Leitungsanschluß: Schraubanschluß: 0,5-2,5 mm²
- Temperaturbereich: -40°C - 125°C
- Kontakte: Kupferlegierung, hartversilbert
- Durchgangswiderstand: <2 mOhm

Technical Data:

- Number of contacts: 3, 6, 10 (+ PE)
- Rated voltage: VDE: 630 V EPIC® H-BVE 3-10
UL: 600 V EPIC® H-BVE 3-10
CSA: 600 V EPIC® H-BVE 3-10
SEV: 660 V EPIC® H-BVE 3-10
- Rated current: VDE: 16 A EPIC® H-BVE 3-10
UL: 16 A EPIC® H-BVE 3-10
CSA: 16 A EPIC® H-BVE 3-10
SEV: 16 A EPIC® H-BVE 3-10
- Pollution level: 3
- Test voltage: 6 kV
- Termination technique: Screw termination: 0,5-2,5 mm²
- Temperature range: -40°C - 125°C
- Contacts: Copper alloy, silver plated
- Contact resistance: <2 mOhm

Caractéristiques techniques:

- Nombre de contacts: 3, 6, 10 (+ PE)
- Tension nominale: VDE: 630 V EPIC® H-BVE 3-10
UL: 600 V EPIC® H-BVE 3-10
CSA: 600 V EPIC® H-BVE 3-10
SEV: 660 V EPIC® H-BVE 3-10
- Courant nominale: VDE: 16 A EPIC® H-BVE 3-10
UL: 16 A EPIC® H-BVE 3-10
CSA: 16 A EPIC® H-BVE 3-10
SEV: 16 A EPIC® H-BVE 3-10
- Degré de pollution: 3
- Tension d'essai: 6 kV
- Raccordement: Raccord à visser: 0,5-2,5 mm²
- Gamme de température: -40°C - 125°C
- Contacts: Alliage cuivre, argenté
- Résistance de passage: <2 mOhm

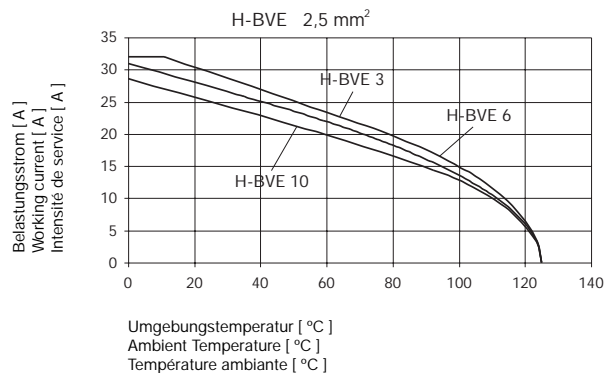
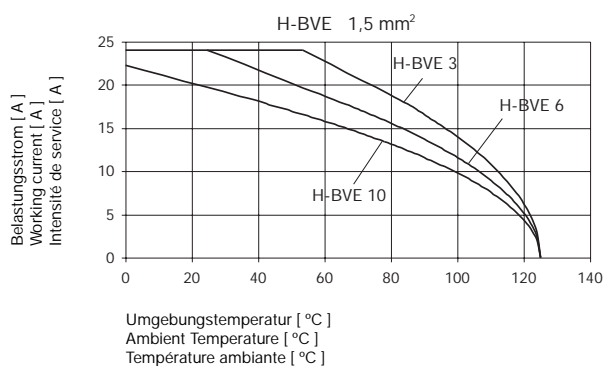

Nur mit CONTACT-Gehäusen verwenden.

Use only with CONTACT housings.

Utilisez seulement avec boîtiers CONTACT.

1.5 EPIC® H - B V E

Einsätze / Inserts / Inserts

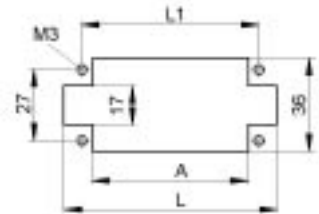
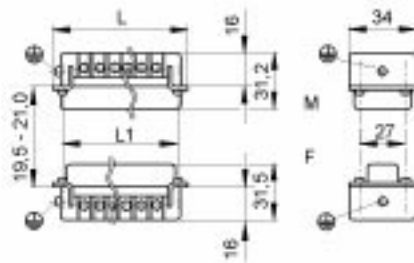

Montageausschnitt
Panel cut-out
Découpe de montage

H-BVE 3

Artikel <i>part article</i>	Version <i>version version</i>	Art.Nr. <i>part No. N° art.</i>	Drahtschutz <i>wire protection protection de fil</i>	Kontakte <i>contacts contacts</i>	L	L1	A
H-BVE 3 SS	Stift / <i>male / mâle</i>	10210010*	●	3	64	57	52
H-BVE 3 BS	Buchse / <i>female / femelle</i>	10211010*	●	3	64	57	52
H-BVE 3 SS	Stift / <i>male / mâle</i>	10210110*		3	64	57	52
H-BVE 3 BS	Buchse / <i>female / femelle</i>	10211110*		3	64	57	52

Gehäuse / *Housings / Boîtiers*:
3.2: H-B 10

Ansicht anschlußseitig
*View from cable side
Vue côté raccordement*

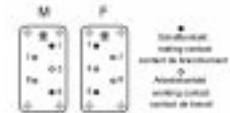

H-BVE 6

Artikel <i>part article</i>	Version <i>version version</i>	Art.Nr. <i>part No. N° art.</i>	Drahtschutz <i>wire protection protection de fil</i>	Kontakte <i>contacts contacts</i>	L	L1	A
H-BVE 6 SS	Stift / <i>male / mâle</i>	10239010*	●	6	84,5	77,5	71
H-BVE 6 BS	Buchse / <i>female / femelle</i>	10240010*	●	6	84,5	77,5	71
H-BVE 6 SS	Stift / <i>male / mâle</i>	10239110*		6	84,5	77,5	71
H-BVE 6 BS	Buchse / <i>female / femelle</i>	10240110*		6	84,5	77,5	71

Gehäuse / *Housings / Boîtiers*:
3.2: H-B 16

Ansicht anschlußseitig
*View from cable side
Vue côté raccordement*

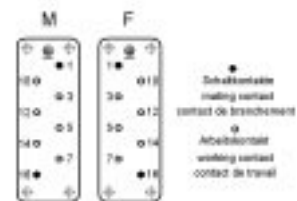

H-BVE 10

Artikel <i>part article</i>	Version <i>version version</i>	Art.Nr. <i>part No. N° art.</i>	Drahtschutz <i>wire protection protection de fil</i>	Kontakte <i>contacts contacts</i>	L	L1	A
H-BVE 10 SS	Stift / <i>male / mâle</i>	10270010*	●	10	111	104	98
H-BVE 10 BS	Buchse / <i>female / femelle</i>	10271010*	●	10	111	104	98
H-BVE 10 SS	Stift / <i>male / mâle</i>	10270110*		10	111	104	98
H-BVE 10 BS	Buchse / <i>female / femelle</i>	10271110*		10	111	104	98

Gehäuse / *Housings / Boîtiers*:
3.2: H-B 24

Ansicht anschlußseitig
*View from cable side
Vue côté raccordement*

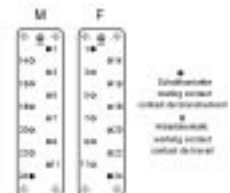

1.6 EPIC® H - D

Einsätze / Inserts / Inserts

Einsätze der Steckverbinderserie H-D sind für Anwendungsfälle konzipiert, bei denen eine hohe Kontaktzahl gefordert ist. Die H-D Reihe gibt es als Crimpausführung für gestanzte und gedrehte Kontakte mit Einsätzen bis zu 128 Kontakten.

The H-D series inserts are designed for use in industry where large numbers of contacts are required. The H-D series is available as a crimp version with stamped and machined contacts with inserts up to 128 contacts.

Les inserts de la série H-D sont conçus pour l'utilisation industrielle, dans laquelle on exige un nombre élevé de contacts. La série H-D existe en version à sertir avec contacts estampés et décolletés avec des inserts jusqu'à 128 contacts.



1.6 EPIC® H - D

Einsätze / Inserts / Inserts

Technische Daten:

- Kontaktzahlen: 8 / 7, 15, 25, 40, 50, 64, 80, 128 (+ PE)
- Bemessungsspannung: VDE: 42/250 V EPIC® H-D 7/8
250 V EPIC® H-D 15-128
UL: 250 V EPIC® H-D 7-128
SEV: 250 V EPIC® H-D 7-128
- Bemessungsstrom: VDE: 10 A EPIC® H-D 7-128
UL: 10 A EPIC® H-D 7-128
SEV: 10 A EPIC® H-D 7-128
- Verschmutzungsgrad: 3
- Prüfspannung: 4 kV
- Leitungsanschluß: Crimpanschluß: 0,14-2,5 mm²
- Temperaturbereich: 40°C - 125°C
- Kontakte: Kupferlegierung,
hartversilbert/hartvergoldet
- Durchgangswiderstand: <2 mOhm

Technical Data:

- Number of contacts: 8 / 7, 15, 25, 40, 50, 64, 80, 128 (+ PE)
- Rated voltage: VDE: 42/250 V EPIC® H-D 7/8
250 V EPIC® H-D 15-128
UL: 250 V EPIC® H-D 7-128
SEV: 250 V EPIC® H-D 7-128
- Rated current: VDE: 10 A EPIC® H-D 7-128
UL: 10 A EPIC® H-D 7-128
SEV: 10 A EPIC® H-D 7-128

- Pollution level: 3
- Test voltage: 4 kV
- Termination technique: Crimp termination: 0,14-2,5 mm²
- Temperature range: -40°C - 125°C
- Contacts: Copper alloy,
silver plated/gold plated
- Contact resistance: <2 mOhm

Caractéristiques techniques:

- Nombre de contacts: 8 / 7, 15, 25, 40, 50, 64, 80, 128 (+ PE)
- Tension nominale: VDE: 42/250 V EPIC® H-D 7/8
250 V EPIC® H-D 15-128
UL: 250 V EPIC® H-D 7-128
SEV: 250 V EPIC® H-D 7-128
- Courant nominale: VDE: 10 A EPIC® H-D 7-128
UL: 10 A EPIC® H-D 7-128
SEV: 10 A EPIC® H-D 7-128
- Degré de pollution: 3
- Tension d'essai: 4 kV
- Raccordement: Raccord à sertir: 0,14-2,5 mm²
- Gamme de température: -40°C - 125°C
- Contacts: Alliage cuivre, argenté/doré
- Résistance de passage: <2 mOhm

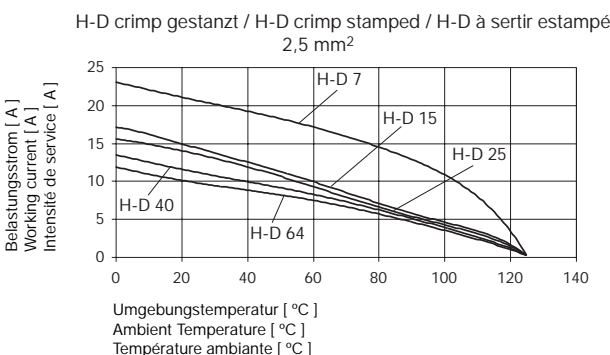
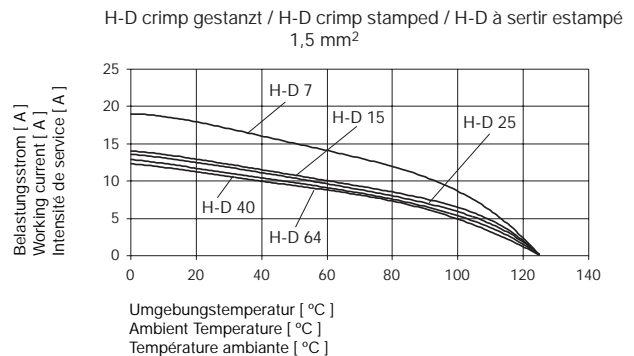
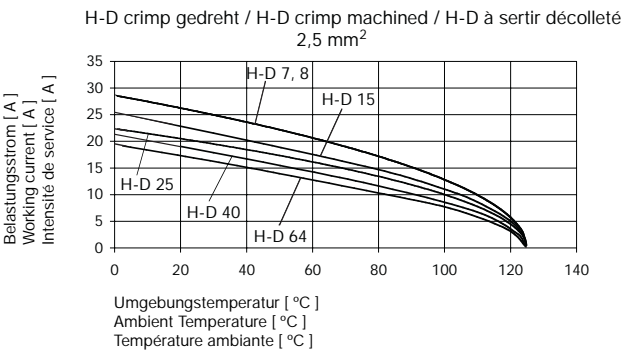
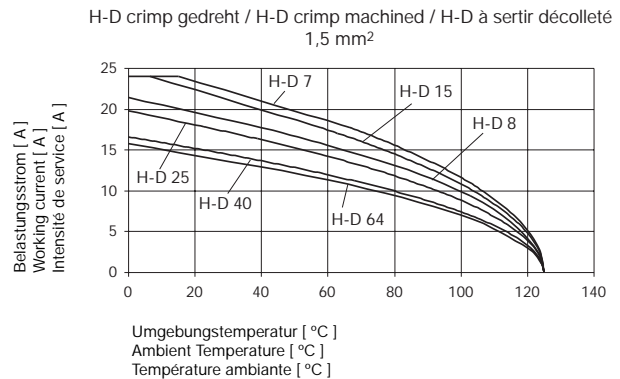
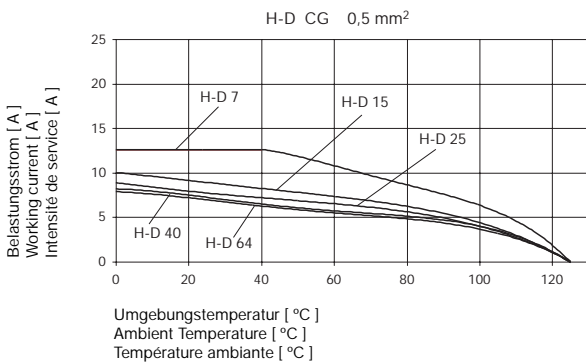

1.6 EPIC® H - D

Einsätze / Inserts / Inserts

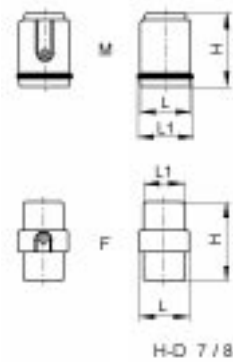

H-D 7

Artikel <i>part</i> <i>article</i>	Version <i>version</i> <i>version</i>	Art.Nr. <i>part No.</i> <i>N° art.</i>	Typ <i>type</i> <i>type</i>	Kontakte <i>contacts</i> <i>contacts</i>	L	L1	H
H-D 7 SCM	Stift / <i>male</i> / <i>mâle</i>	11250500*	gedreht / <i>machined</i> / <i>décolleté</i>	7	21	23,6	34
H-D 7 BCM	Buchse / <i>female</i> / <i>femelle</i>	11251500*		7	21	17	33,2
H-D 7 SCG	Stift / <i>male</i> / <i>mâle</i>	11250000*	gestanzt / <i>stamped</i> / <i>estampé</i>	7	21	23,6	33,6
H-D 7 BCG	Buchse / <i>female</i> / <i>femelle</i>	11251000*		7	21	17	32,2

Gehäuse / *Housings* / *Boîtiers*: 3.1: H-A 3
 Kontakte / *Contacts* / *Contacts*: 2.1: H-D 1,6 gedreht / *machined* / *décolleté*
 H-D 1,6 gestanzt / *stamped* / *estampé*

Ansicht anschlußseitig
View from cable side
Vue côté raccordement

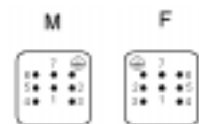

H-D 8

Artikel <i>part</i> <i>article</i>	Version <i>version</i> <i>version</i>	Art.Nr. <i>part No.</i> <i>N° art.</i>	Typ <i>type</i> <i>type</i>	Kontakte <i>contacts</i> <i>contacts</i>	L	L1	H
H-D 8 SCM	Stift / <i>male</i> / <i>mâle</i>	11252500*	gedreht / <i>machined</i> / <i>décolleté</i>	8	21	23,6	34
H-D 8 BCM	Buchse / <i>female</i> / <i>femelle</i>	11253500*		8	21	17	33,2

Gehäuse / *Housings* / *Boîtiers*: 3.1: H-A 3
 Kontakte / *Contacts* / *Contacts*: 2.1: H-D 1,6 gedreht / *machined* / *décolleté*

Ansicht anschlußseitig
View from cable side
Vue côté raccordement

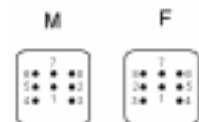

1.6 EPIC® H - D

Einsätze / Inserts / Inserts

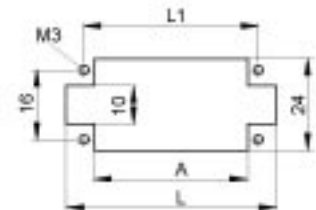
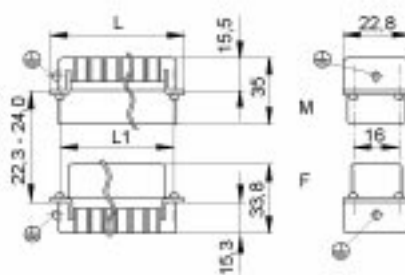

Montageausschnitt
Panel cut-out
Découpe de montage

H-D 15

Artikel <i>part</i> <i>article</i>	Version <i>version</i> <i>version</i>	Art.Nr. <i>part No.</i> <i>N° art.</i>	Typ <i>type</i> <i>type</i>	Kontakte <i>contacts</i> <i>contacts</i>	L	L1	A
H-D 15 SCM	Stift / <i>male / mâle</i>	11255100*	gedreht / <i>machined / décolleté</i>	15	56,5	49,5	42,5
H-D 15 BCM	Buchse / <i>female / femelle</i>	11256100*		15	56,5	49,5	42,5
H-D 15 SCG	Stift / <i>male / mâle</i>	11255000	gestanzt / <i>stamped / estampé</i>	15	56,5	49,5	42,5
H-D 15 BCG	Buchse / <i>female / femelle</i>	11256000		15	56,5	49,5	42,5

Gehäuse / *Housings / Boîtiers*: 3.1: H-A 10
Kontakte / *Contacts / Contacts*: 2.1: H-D 1,6 gedreht / *machined / décolleté*
H-D 1,6 gestanzt / *stamped / estampé*

Ansicht anschlußseitig
View from cable side
Vue côté raccordement



H-D 25

Artikel <i>part</i> <i>article</i>	Version <i>version</i> <i>version</i>	Art.Nr. <i>part No.</i> <i>N° art.</i>	Typ <i>type</i> <i>type</i>	Kontakte <i>contacts</i> <i>contacts</i>	L	L1	A
H-D 25 SCM	Stift / <i>male / mâle</i>	11260200*	gedreht / <i>machined / décolleté</i>	25	73	66	60
H-D 25 BCM	Buchse / <i>female / femelle</i>	11261200*		25	73	66	60
H-D 25 SCG	Stift / <i>male / mâle</i>	11260000	gestanzt / <i>stamped / estampé</i>	25	73	66	60
H-D 25 BCG	Buchse / <i>female / femelle</i>	11261000		25	73	66	60

Gehäuse / *Housings / Boîtiers*: 3.1: H-A 16
Kontakte / *Contacts / Contacts*: 2.1: H-D 1,6 gedreht / *machined / décolleté*
H-D 1,6 gestanzt / *stamped / estampé*

Ansicht anschlußseitig
View from cable side
Vue côté raccordement

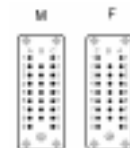

H-D 50

Artikel <i>part</i> <i>article</i>	Version <i>version</i> <i>version</i>	Art.Nr. <i>part No.</i> <i>N° art.</i>	Typ <i>type</i> <i>type</i>	Kontakte <i>contacts</i> <i>contacts</i>	L	L1	A
H-D 25 SCM (2x)	Stift / <i>male / mâle</i>	11260200 (2x)*	gedreht / <i>machined / décolleté</i>	50	73	66	60
H-D 25 BCM (2x)	Buchse / <i>female / femelle</i>	11261200 (2x)*		50	73	66	60
H-D 25 SCG (2x)	Stift / <i>male / mâle</i>	11260000 (2x)	gestanzt / <i>stamped / estampé</i>	50	73	66	60
H-D 25 BCG (2x)	Buchse / <i>female / femelle</i>	11261000 (2x)		50	73	66	60

Gehäuse / *Housings / Boîtiers*: 3.1: H-A 32
Kontakte / *Contacts / Contacts*: 2.1: H-D 1,6 gedreht / *machined / décolleté*
H-D 1,6 gestanzt / *stamped / estampé*

Ansicht anschlußseitig
View from cable side
Vue côté raccordement

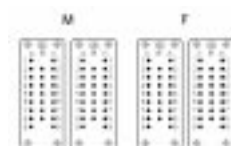

1.6 EPIC® H - D

Einsätze / Inserts / Inserts

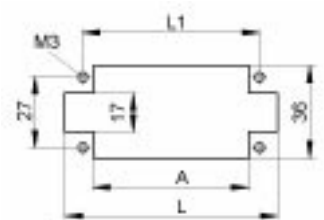
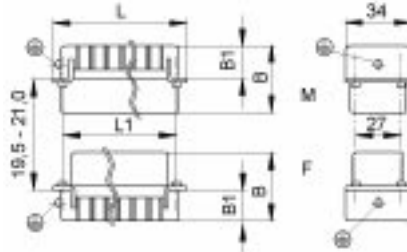

Montageausschnitt
Panel cut-out
Découpe de montage

H-D 40

Artikel <i>part</i> <i>article</i>	Version <i>version</i> <i>version</i>	Art.Nr. <i>part No.</i> <i>N° art.</i>	Typ <i>type</i> <i>type</i>	Kontakte <i>contacts</i> <i>contacts</i>	L	L1	A	B	B1
H-D 40 SCM	Stift / <i>male</i> / <i>mâle</i>	11265200	gedreht / <i>machined</i> / <i>décolleté</i>	40	84,5	77,5	71	39,3	24
H-D 40 BCM	Buchse / <i>female</i> / <i>femelle</i>	11266200		40	84,5	77,5	71	34,6	16
H-D 40 SCG	Stift / <i>male</i> / <i>mâle</i>	11265000	gestanzt / <i>stamped</i> / <i>estampé</i>	40	84,5	77,5	71	34	19
H-D 40 BCG	Buchse / <i>female</i> / <i>femelle</i>	11266000		40	84,5	77,5	71	36	18

Gehäuse / *Housings* / *Boîtiers*: 3.2: H-B 16
Kontakte / *Contacts* / *Contacts*: 2.1: H-D 1,6 gedreht / *machined* / *décolleté*
H-D 1,6 gestanzt / *stamped* / *estampé*

Ansicht anschlußseitig
View from cable side
Vue côté raccordement

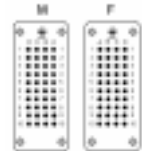

H-D 64

Artikel <i>part</i> <i>article</i>	Version <i>version</i> <i>version</i>	Art.Nr. <i>part No.</i> <i>N° art.</i>	Typ <i>type</i> <i>type</i>	Kontakte <i>contacts</i> <i>contacts</i>	L	L1	A	B	B1
H-D 64 SCM	Stift / <i>male</i> / <i>mâle</i>	11272000	gedreht / <i>machined</i> / <i>décolleté</i>	64	111	104	98	39,3	24
H-D 64 BCM	Buchse / <i>female</i> / <i>femelle</i>	11273000		64	111	104	98	34,6	16
H-D 64 SCG	Stift / <i>male</i> / <i>mâle</i>	11270000	gestanzt / <i>stamped</i> / <i>estampé</i>	64	111	104	98	34	19
H-D 64 BCG	Buchse / <i>female</i> / <i>femelle</i>	11271000		64	111	104	98	36	18

Gehäuse / *Housings* / *Boîtiers*: 3.2: H-B 24
Kontakte / *Contacts* / *Contacts*: 2.1: H-D 1,6 gedreht / *machined* / *décolleté*
H-D 1,6 gestanzt / *stamped* / *estampé*

Ansicht anschlußseitig
View from cable side
Vue côté raccordement

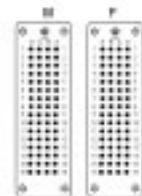

1.6 EPIC® H - D

Einsätze / Inserts / Inserts

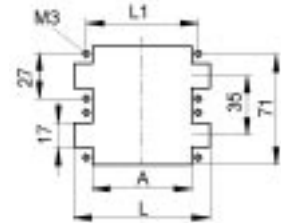
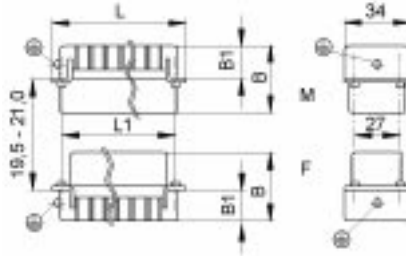

Montageausschnitt
Panel cut-out
Découpe de montage

H-D 80

Artikel <i>part</i> <i>article</i>	Version <i>version</i> <i>version</i>	Art.Nr. <i>part No.</i> <i>N° art.</i>	Typ <i>type</i> <i>type</i>	Kontakte <i>contacts</i> <i>contacts</i>	L	L1	A	B	B1
H-D 40 SCM (2x)	Stift / <i>male</i> / <i>mâle</i>	11265200 (2x)	gedreht / <i>machined</i> / <i>décolleté</i>	2 x 40	84,5	77,5	71	39,3	24
H-D 40 BCM (2x)	Buchse / <i>female</i> / <i>femelle</i>	11266200 (2x)		2 x 40	84,5	77,5	71	34,6	16
H-D 40 SCG (2x)	Stift / <i>male</i> / <i>mâle</i>	11265000 (2x)	gestanzt / <i>stamped</i> / <i>estampé</i>	2 x 40	84,5	77,5	71	34	19
H-D 40 BCG (2x)	Buchse / <i>female</i> / <i>femelle</i>	11266000 (2x)		2 x 40	84,5	77,5	71	36	18

Gehäuse / *Housings* / *Boîtiers*: 3.2: H-B 32
Kontakte / *Contacts* / *Contacts*: 2.1: H-D 1,6 gedreht / *machined* / *décolleté*
H-D 1,6 gestanzt / *stamped* / *estampé*

Ansicht anschlußseitig
View from cable side
Vue côté raccordement

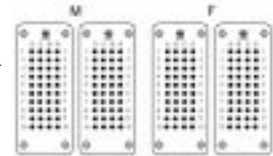

H-D 128

Artikel <i>part</i> <i>article</i>	Version <i>version</i> <i>version</i>	Art.Nr. <i>part No.</i> <i>N° art.</i>	Typ <i>type</i> <i>type</i>	Kontakte <i>contacts</i> <i>contacts</i>	L	L1	A	B	B1
H-D 64 SCM (2x)	Stift / <i>male</i> / <i>mâle</i>	11272000 (2x)	gedreht / <i>machined</i> / <i>décolleté</i>	128	111	104	98	39,3	24
H-D 64 BCM (2x)	Buchse / <i>female</i> / <i>femelle</i>	11273000 (2x)		128	111	104	98	34,6	16
H-D 64 SCG (2x)	Stift / <i>male</i> / <i>mâle</i>	11270000 (2x)	gestanzt / <i>stamped</i> / <i>estampé</i>	128	111	104	98	34	19
H-D 64 BCG (2x)	Buchse / <i>female</i> / <i>femelle</i>	11271000 (2x)		128	111	104	98	36	18

Gehäuse / *Housings* / *Boîtiers*: 3.2: H-B 48
Kontakte / *Contacts* / *Contacts*: 2.1: H-D 1,6 gedreht / *machined* / *décolleté*
H-D 1,6 gestanzt / *stamped* / *estampé*

Ansicht anschlußseitig
View from cable side
Vue côté raccordement

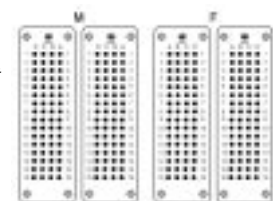

1.7 EPIC® H - D D

Einsätze / Inserts / Inserts

Die H-DD Reihe mit gedrehten Kontakten ist ausgelegt für hohe Polzahlen auf engstem Raum. Dadurch kann eine kleinere Gehäusebauform gewählt werden. So sparen Sie mit dieser Steckverbinderserie Platz bei der Installation ohne auf große Polzahlen verzichten zu müssen.

The H-DD series with machined contacts is designed for large numbers of contacts in narrow spaces. Therefore a smaller housings design can be used. With this connector series you can save installation space without having to forgo a large number of poles.

La série H-DD avec ses contacts décollés est étudié pour un nombre élevé de broches avec un minimum d'encombrement. Ceci permet de sélectionner un modèle de boîtier plus petit. Avec ces inserts, vous économisez ainsi de la place lors de l'installation sans devoir renoncer à un nombre élevé de broches.

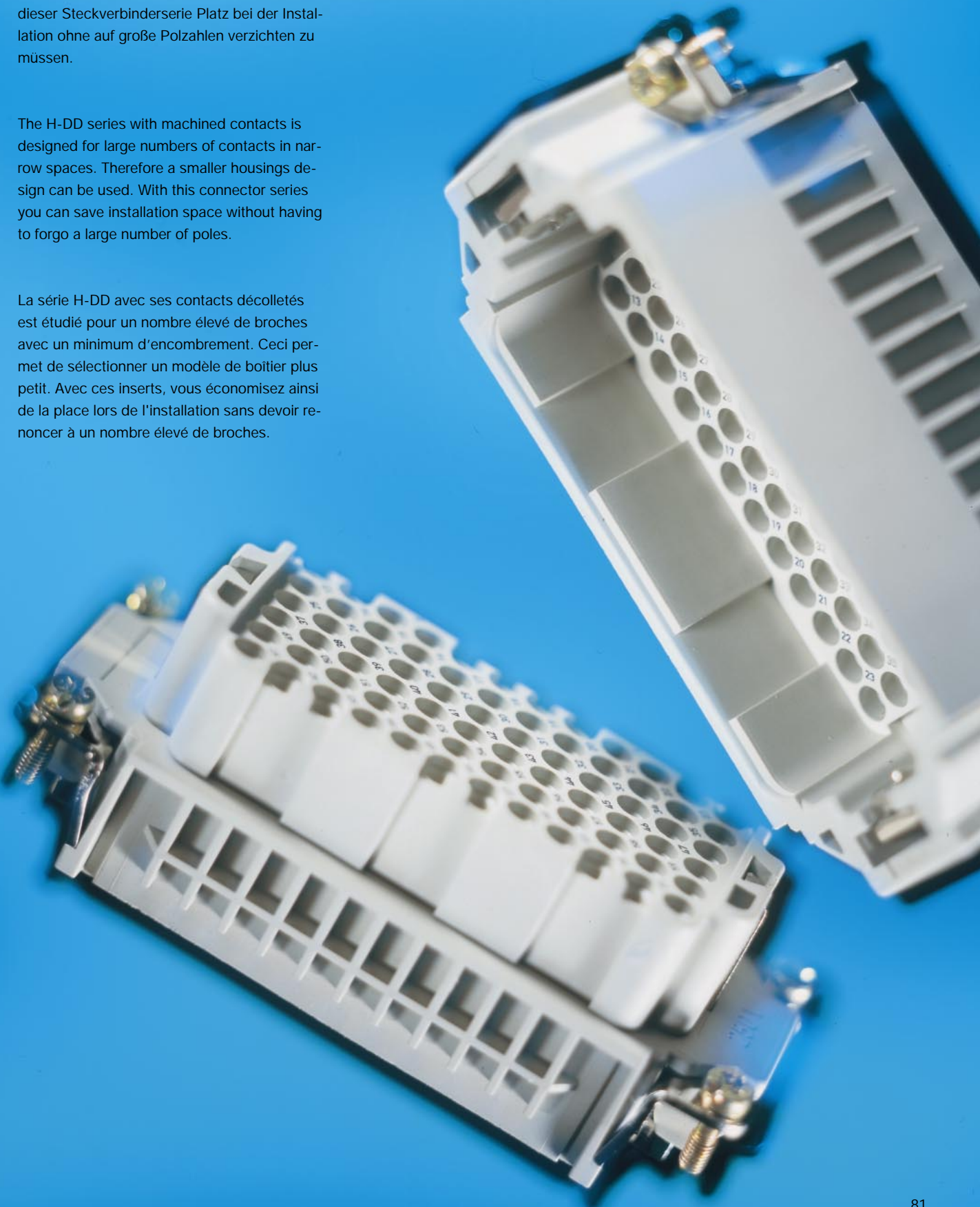

1.7 EPIC® H - D D

Einsätze / Inserts / Inserts

Technische Daten:

- Kontaktzahlen: 24, 42, 72, 108, 144, 216 (+ PE)
- Bemessungsspannung: VDE: 250 V EPIC® H-DD 24-216
UL: 600 V EPIC® H-DD 24-216
CSA: 600 V EPIC® H-DD 24-216
SEV: 250 V EPIC® H-DD 24-216
- Bemessungsstrom: VDE: 10 A EPIC® H-DD 24-216
UL: 8,5 A EPIC® H-DD 24-216
CSA: 20 A EPIC® H-DD 24-216
SEV: 10 A EPIC® H-DD 24-216
- Verschmutzungsgrad: 3
- Prüfspannung: 2 kV
- Leitungsanschluß: Crimpanschluß: 0,14-2,5 mm²
- Temperaturbereich: -40°C - 125°C
- Kontakte: Kupferlegierung,
hartversilbert/hartvergoldet
- Durchgangswiderstand: <2 mOhm

Technical Data:

- Number of contacts: 24, 42, 72, 108, 144, 216 (+ PE)
- Rated voltage: VDE: 250 V EPIC® H-DD 24-216
UL: 600 V EPIC® H-DD 24-216
CSA: 600 V EPIC® H-DD 24-216
SEV: 250 V EPIC® H-DD 24-216
- Rated current: VDE: 10 A EPIC® H-DD 24-216
UL: 8,5 A EPIC® H-DD 24-216
CSA: 20 A EPIC® H-DD 24-216
SEV: 10 A EPIC® H-DD 24-216
- Pollution level: 3
- Test voltage: 2 kV
- Termination technique: Crimp termination: 0,14-2,5 mm²
- Temperature range: -40°C - 125°C
- Contacts: Copper alloy,
silver plated/gold plated
- Contact resistance: <2 mOhm

Caractéristiques techniques:

- Nombre de contacts: 24, 42, 72, 108, 144, 216 (+ PE)
- Tension nominale: VDE: 250 V EPIC® H-DD 24-216
UL: 600 V EPIC® H-DD 24-216
CSA: 600 V EPIC® H-DD 24-216
SEV: 250 V EPIC® H-DD 24-216
- Courant nominale: VDE: 10 A EPIC® H-DD 24-216
UL: 8,5 A EPIC® H-DD 24-216
CSA: 20 A EPIC® H-DD 24-216
SEV: 10 A EPIC® H-DD 24-216
- Degré de pollution: 3
- Tension d'essai: 2 kV
- Raccordement: Raccord à sertir: 0,14-2,5 mm²
- Gamme de température: -40°C - 125°C
- Contacts: Alliage cuivre, argenté/doré
- Résistance de passage: <2 mOhm

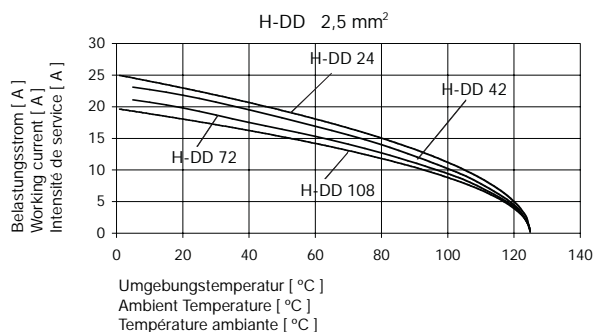
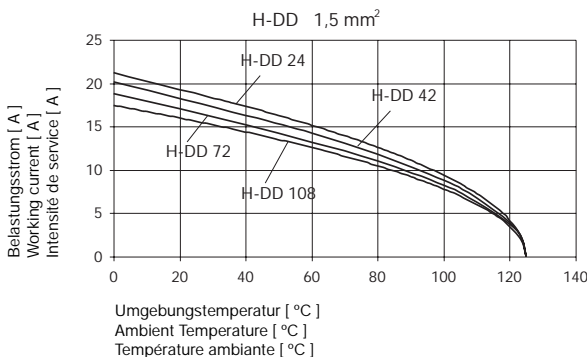

1.7 EPIC® H - D D

Einsätze / Inserts / Inserts

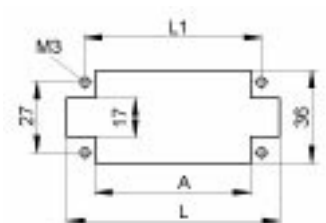
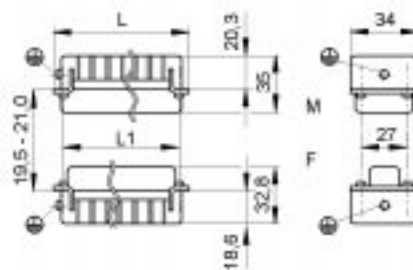

Montageausschnitt
Panel cut-out
Découpe de montage

H-DD 24

Artikel <i>part</i> <i>article</i>	Version <i>version</i> <i>version</i>	Art.Nr. <i>part No.</i> <i>N° art.</i>	Typ <i>type</i> <i>type</i>	Kontakte <i>contacts</i> <i>contacts</i>	L	L1	A
H-DD 24 SCM	Stift / <i>male</i> / <i>mâle</i>	11285000*	gedreht / <i>machined</i> / <i>décolleté</i>	24	50,5	44	36
H-DD 24 BCM	Buchse / <i>female</i> / <i>femelle</i>	11286000*		24	50,5	44	36

Gehäuse / *Housings* / *Boîtiers*: 3.2: H-B 6
Kontakte / *Contacts* / *Contacts*: 2.1: H-D 1,6 gedreht / *machined* / *décolleté*

Ansicht anschlußseitig
View from cable side
Vue côté raccordement

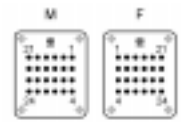

H-DD 42

Artikel <i>part</i> <i>article</i>	Version <i>version</i> <i>version</i>	Art.Nr. <i>part No.</i> <i>N° art.</i>	Typ <i>type</i> <i>type</i>	Kontakte <i>contacts</i> <i>contacts</i>	L	L1	A
H-DD 42 SCM	Stift / <i>male</i> / <i>mâle</i>	11285100*	gedreht / <i>machined</i> / <i>décolleté</i>	42	63,5	57	49
H-DD 42 BCM	Buchse / <i>female</i> / <i>femelle</i>	11286100*		42	63,5	57	49

Gehäuse / *Housings* / *Boîtiers*: 3.2: H-B 10
Kontakte / *Contacts* / *Contacts*: 2.1: H-D 1,6 gedreht / *machined* / *décolleté*

Ansicht anschlußseitig
View from cable side
Vue côté raccordement

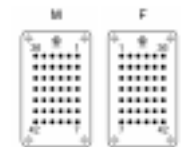

H-DD 72

Artikel <i>part</i> <i>article</i>	Version <i>version</i> <i>version</i>	Art.Nr. <i>part No.</i> <i>N° art.</i>	Typ <i>type</i> <i>type</i>	Kontakte <i>contacts</i> <i>contacts</i>	L	L1	A
H-DD 72 SCM	Stift / <i>male</i> / <i>mâle</i>	11285200*	gedreht / <i>machined</i> / <i>décolleté</i>	72	84	77,5	69,5
H-DD 72 BCM	Buchse / <i>female</i> / <i>femelle</i>	11286200*		72	84	77,5	69,5

Gehäuse / *Housings* / *Boîtiers*: 3.2: H-B 16
Kontakte / *Contacts* / *Contacts*: 2.1: H-D 1,6 gedreht / *machined* / *décolleté*

Ansicht anschlußseitig
View from cable side
Vue côté raccordement

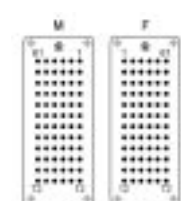

1.7 EPIC® H - D D

Einsätze / Inserts / Inserts

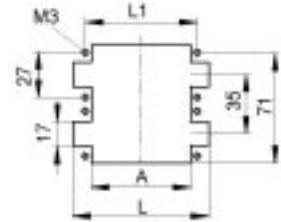
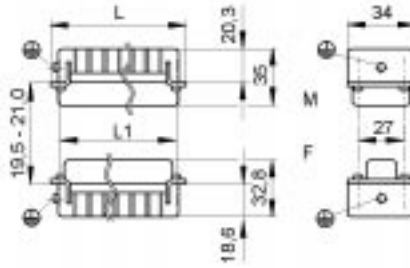

Montageausschnitt
Panel cut-out
Découpe de montage

H-DD 108

Artikel <i>part</i> <i>article</i>	Version <i>version</i> <i>version</i>	Art.Nr. <i>part No.</i> <i>N° art.</i>	Typ <i>type</i> <i>type</i>	Kontakte <i>contacts</i> <i>contacts</i>	L	L1	A
H-DD 108 SCM	Stift / <i>male</i> / <i>mâle</i>	11285300*	gedreht / <i>machined</i> / <i>décolleté</i>	108	110,5	104	96
H-DD 108 BCM	Buchse / <i>female</i> / <i>femelle</i>	11286300*		108	110,5	104	96

Gehäuse / *Housings* / *Boîtiers*: 3.2: H-B 24
Kontakte / *Contacts* / *Contacts*: 2.1: H-D 1,6 gedreht / *machined* / *décolleté*
Montageausschnitt siehe vorherige Seite / *Panel cut-out see previous page* /
Découpe de montage voir page précédente

Ansicht anschlußseitig
View from cable side
Vue côté raccordement

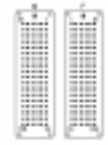

H-DD 144

Artikel <i>part</i> <i>article</i>	Version <i>version</i> <i>version</i>	Art.Nr. <i>part No.</i> <i>N° art.</i>	Typ <i>type</i> <i>type</i>	Kontakte <i>contacts</i> <i>contacts</i>	L	L1	A
H-DD 72 SCM 1-72	Stift / <i>male</i> / <i>mâle</i>	11285200*	gedreht / <i>machined</i> / <i>décolleté</i>	144	84	77,5	69,5
H-DD 72 SCM 73-144		11285400*			84	77,5	69,5
H-DD 72 BCM 1-72	Buchse / <i>female</i> / <i>femelle</i>	11286200*	gedreht / <i>machined</i> / <i>décolleté</i>	144	84	77,5	69,5
H-DD 72 BCM 73-144		11286400*			84	77,5	69,5

Gehäuse / *Housings* / *Boîtiers*: 3.2: H-B 32
Kontakte / *Contacts* / *Contacts*: 2.1: H-D 1,6 gedreht / *machined* / *décolleté*

Ansicht anschlußseitig
View from cable side
Vue côté raccordement



H-DD 216

Artikel <i>part</i> <i>article</i>	Version <i>version</i> <i>version</i>	Art.Nr. <i>part No.</i> <i>N° art.</i>	Typ <i>type</i> <i>type</i>	Kontakte <i>contacts</i> <i>contacts</i>	L	L1	A
H-DD 108 SCM 1-108	Stift / <i>male</i> / <i>mâle</i>	11285300*	gedreht / <i>machined</i> / <i>décolleté</i>	216	110,5	104	96
H-DD 108 SCM 109-216		11285500			110,5	104	96
H-DD 108 BCM 1-108	Buchse / <i>female</i> / <i>femelle</i>	11286300*	gedreht / <i>machined</i> / <i>décolleté</i>	216	110,5	104	96
H-DD 108 BCM 109-216		11286500			110,5	104	96

Gehäuse / *Housings* / *Boîtiers*: 3.2: H-B 48
Kontakte / *Contacts* / *Contacts*: 2.1: H-D 1,6 gedreht / *machined* / *décolleté*

Ansicht anschlußseitig
View from cable side
Vue côté raccordement

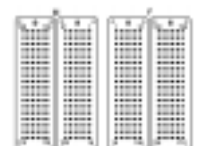

1.8 EPIC® M C

Einsätze / Inserts / Inserts

Immer mehr Anwender entscheiden sich für die intelligente Mischbestückung, maßgeschneidert auf Ihre Bedürfnisse. Jetzt auch halogen- und phosphorfrei! Das EPIC® Modul System wird ständig erweitert. So ist eine hohe Flexibilität garantiert.

More and more users are deciding in favour of intelligent mixed equipment, tailored to their specific requirements. Now always halogen- and phosphorus-free! The EPIC® Modular System is being constantly expanded. Ensuring high flexibility.

De plus en plus d'utilisateurs optent en faveur d'un équipement mixte intelligent, taillé sur mesure en fonction de leurs besoins – et maintenant exempt d'halogènes et de phosphore! Le système modulaire EPIC® évolue en constante évolution. Vous garantit une flexibilité élevée.



1.8 EPIC® M C

Einsätze / Inserts / Inserts

Technische Daten

- Polzahl: 3 - 280
- Bemessungsspannung: ... VDE: 100-1000 V
UL: 63-600V
CSA: 60-600 V
SEV: 63-630 V
- Bemessungsstrom: VDE: 5-50 A
UL: 10-40 A
CSA: 5-40 A
SEV: 5-40 A
- Verschmutzungsgrad: 3
- Prüfspannung: 1,5-8 kV, abhängig vom Modul
- Leitungsanschluß: Crimpanschluß: 0,14-10 mm²
Käfigzugfeder: 0,5-4,0 mm²
- Temperaturbereich: -40°C - + 125°C
- Kontakte: Kupferlegierung,
hartversilbert/hartvergoldet
- Durchgangswiderstand: ... < 1mOhm - < 5mOhm
- Brandverhalten: UL 94 V-O

Technical Data

- Number of contacts: 3 - 280
- Rated voltage: VDE: 100-1000 V
UL: 63-600 V
CSA: 60-600 V
SEV: 63-630 V
- Rated current: VDE: 5-50 A
UL: 10-40 A
CSA: 5-40 A
SEV: 5-40 A
- Pollution level: 3
- Test voltage: 1,5-8 kV, depending on module
- Termination technique: Crimp termination: 0,06-10 mm²
Cage clamp: 0,5-4,0 mm²
- Temperature range: -40°C - 125°C
- Contacts: Copper alloy,
silver plated/gold plated
- Contact resistance: < 1mOhm - < 5mOhm,

Caractéristiques techniques

- Nombre de contacts: 3 - 280
- Tension nominale: VDE: 100-1000 V
UL: 63-600 V
CSA: 60-600 V
SEV: 63-630 V
- Courant nominale: VDE: 5-50 A
UL: 10-40 A
CSA: 5-40 A
SEV: 5-40 A
- Degré de pollution: 3
- Tension d'essai: 1,5-8 kV, dépendant de module
- Raccordement: Raccord à sertir: 0,06-10 mm²
Lame de pression: 0,5-4,0mm²
- Plage de température: -40°C - 125°C
- Contacts: Alliage cuivre, argenté/doré
- Résistance de passage: ... < 1mOhm - < 5mOhm,

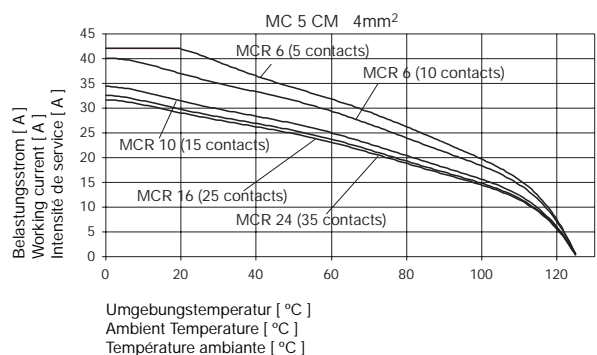
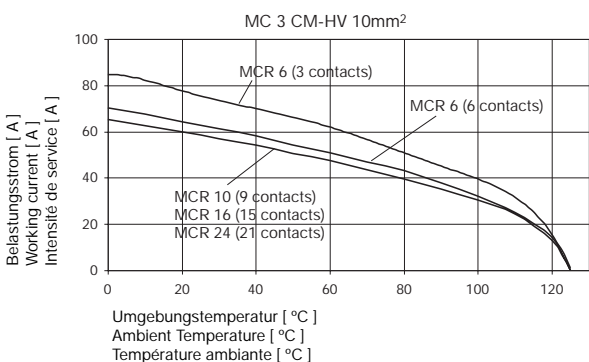
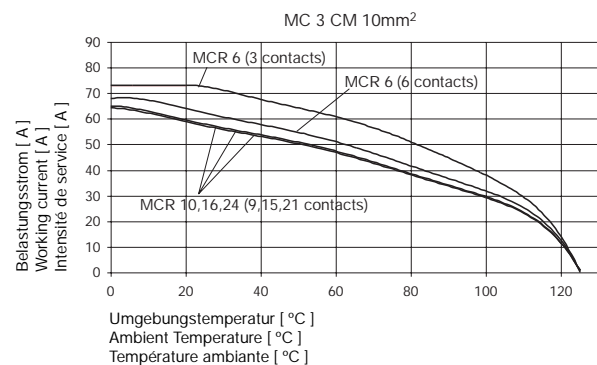
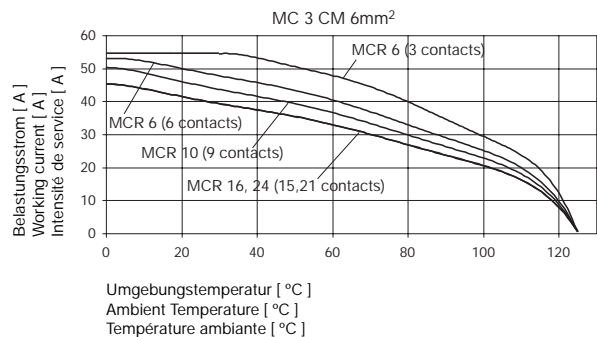
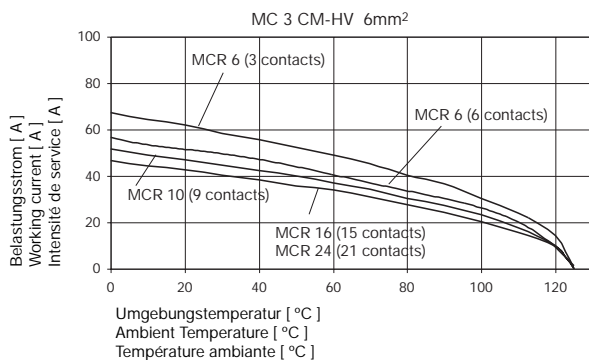

1.8 EPIC® M C

Einsätze / Inserts / Inserts

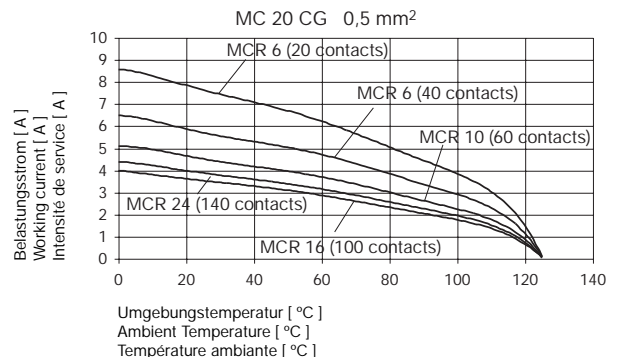
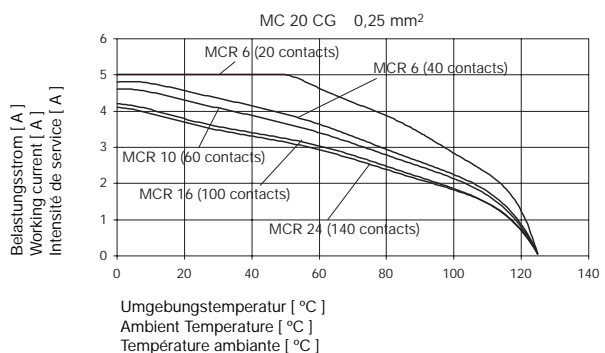
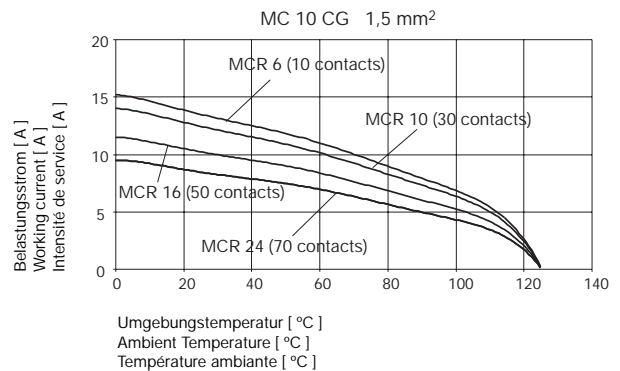
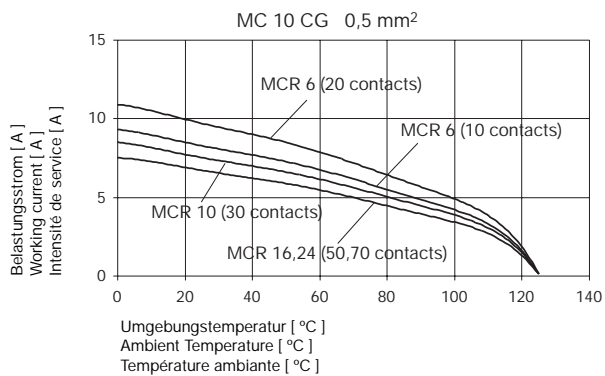
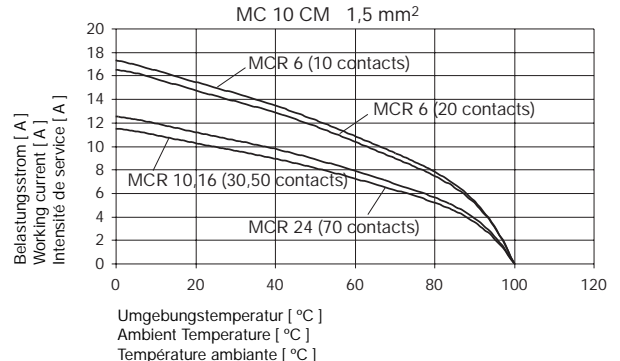
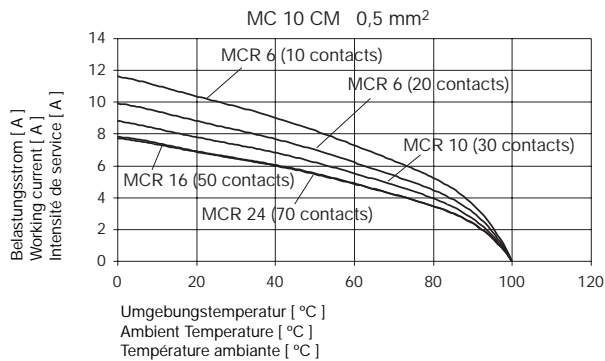
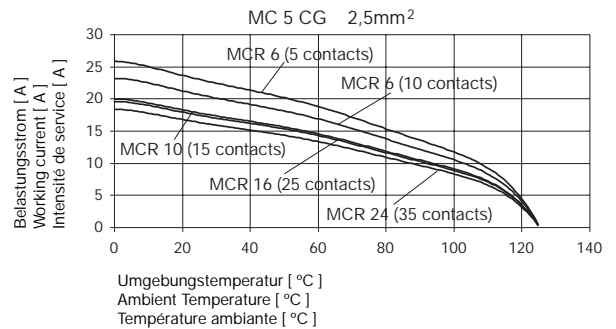
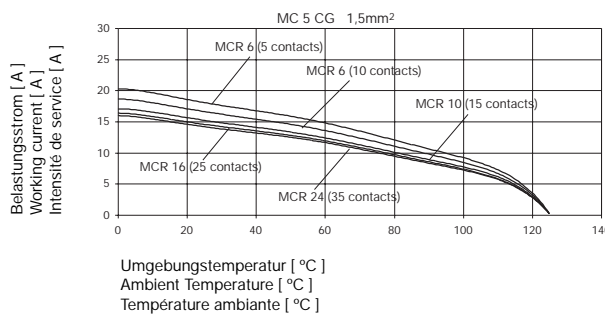
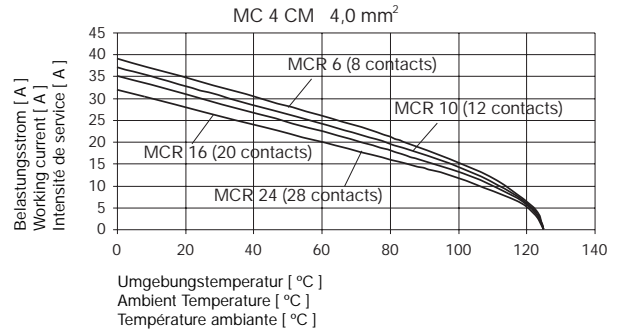
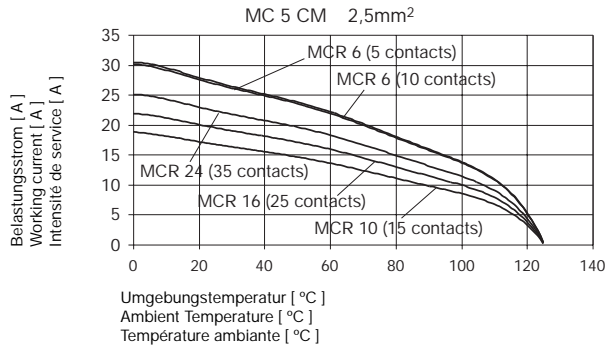

1.8 EPIC® M C

Einsätze / Inserts / Inserts

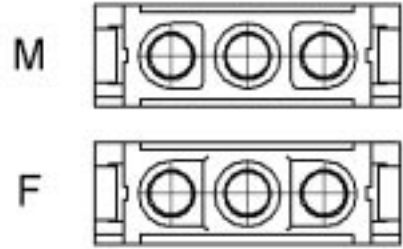

Modul: Koax / module: koax / module: koax (DIN 41612)

Artikel <i>part</i> <i>article</i>	Version <i>version</i> <i>version</i>	Art. Nr. <i>part No.</i> <i>N° art.</i>	Kontakte <i>contacts</i> <i>contacts</i>	Bemessungs- spannung <i>rated voltage</i> <i>tension nominale</i>	Kabelgrößen <i>cable sizes</i> <i>taille de câbles</i>	Wellenwiderstand <i>impedance</i> <i>impédance</i>
MCS 3 Koax	Stift / <i>male</i> / <i>mâle</i>	10399200	3	250 V	RG 58	50 Ohm
MCB 3 Koax	Buchse / <i>female</i> / <i>femelle</i>	10399300	3	250 V	RG 58	50 Ohm

Rahmen / *Frames* / *Cadre*: MCR 6/10/16/24
Kontakte / *Contacts* / *Contacts*: 2.1: MC Koax

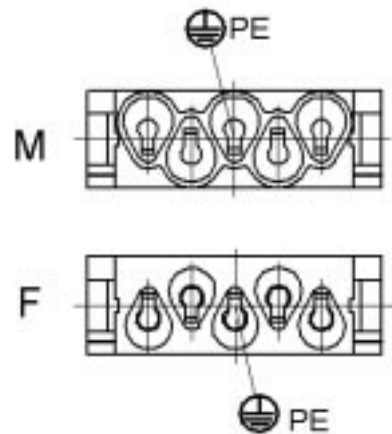

Modul: Hochspannung / module: high voltage / module: haute tension

Artikel <i>part</i> <i>article</i>	Version <i>version</i> <i>version</i>	Art. Nr. <i>part No.</i> <i>N° art.</i>	Kontakte <i>contacts</i> <i>contacts</i>	Bemessungsspannung <i>rated voltage</i> <i>tension nominale</i>	Bemessungsstrom <i>rated current</i> <i>courant nominale</i>
MCS 5 CG	Stift / <i>male</i> / <i>mâle</i>	10383200	4+PE	1000 V	16 A
MCB 5 CG	Buchse / <i>female</i> / <i>femelle</i>	10383300	4+PE	1000 V	16 A

Rahmen / *Frames* / *Cadre*: MCR 6/10/16/24
Kontakte / *Contacts* / *Contacts*: 2.1: MC 2,5 gestanz / *stamped* / *estampé*

1.8 EPIC® M C

Einsätze / Inserts / Inserts

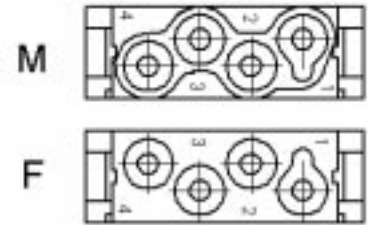

Modul: HE / module: HE / module: HE

Artikel <i>part</i> <i>article</i>	Version <i>version</i> <i>version</i>	Art. Nr. <i>part No.</i> <i>N° art.</i>	Kontakte <i>contacts</i> <i>contacts</i>	Bemessungsspannung <i>rated voltage</i> <i>tension nominale</i>	Bemessungsstrom <i>rated current</i> <i>courant nominale</i>
MCS 4 CM	Stift / <i>male</i> / <i>mâle</i>	10399000	4	630 V	25 A
MCB 4 CM	Buchse / <i>female</i> / <i>femelle</i>	10399100	4	630 V	25 A

Rahmen / *Frames* / *Cadre*: MCR 6/10/16/24

Kontakte / *Contacts* / *Contacts*: 2.1: H-BE 2,5 gedreht / *machined* / *décolleté*

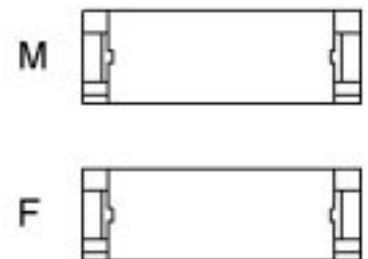

Modul: Blind / module: dummy / module: borgne

Artikel <i>part</i> <i>article</i>	Version <i>version</i> <i>version</i>	Art. Nr. <i>part No.</i> <i>N° art.</i>	Kontakte <i>contacts</i> <i>contacts</i>	Bemessungsspannung <i>rated voltage</i> <i>tension nominale</i>	Bemessungsstrom <i>rated current</i> <i>courant nominale</i>
MCS 0 Blind	Stift / <i>male</i> / <i>mâle</i>	10399400	0	----	----
MCB 0 Blind	Buchse / <i>female</i> / <i>femelle</i>	10399500	0	----	----

Rahmen / *Frames* / *Cadre*: MCR 6/10/16/24

1.8 EPIC® M C

Einsätze / Inserts / Inserts

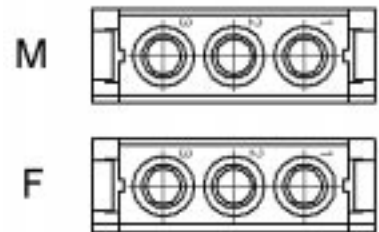

Modul: 3-polig / Module: 3-contacts / Module: 3-contacts

Artikel <i>part</i> <i>article</i>	Version <i>version</i> <i>version</i>	Art. Nr. <i>part No.</i> <i>N° art.</i>	Kontakte <i>contacts</i> <i>contacts</i>	Bemessungsspannung <i>rated voltage</i> <i>tension nominale</i>	Bemessungsstrom <i>rated current</i> <i>courant nominale</i>
MCS 3 CM	Stift / <i>male</i> / <i>mâle</i>	10382000*	3	630 V	40 A
MCB 3 CM	Buchse / <i>female</i> / <i>femelle</i>	10382100*	3	630 V	40 A

Rahmen / *Frames* / *Cadre*: MCR 6/10/16/24

Kontakte / *Contacts* / *Contacts*: 2.1: MC 3,6 gedreht / *machined* / *décolleté*

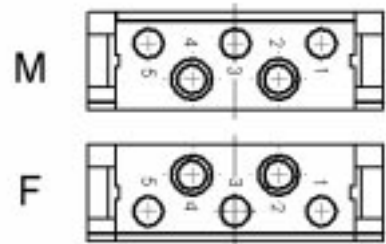

Modul: 5-polig / Module: 5-contacts / Module: 5-contacts

Artikel <i>part</i> <i>article</i>	Version <i>version</i> <i>version</i>	Art. Nr. <i>part No.</i> <i>N° art.</i>	Kontakte <i>contacts</i> <i>contacts</i>	Bemessungsspannung <i>rated voltage</i> <i>tension nominale</i>	Bemessungsstrom <i>rated current</i> <i>courant nominale</i>
MCS 5 CM	Stift / <i>male</i> / <i>mâle</i>	10382200*	5	440 V	20 A
MCB 5 CM	Buchse / <i>female</i> / <i>femelle</i>	10382300*	5	440 V	20 A

Rahmen / *Frames* / *Cadre*: MCR 6/10/16/24

Kontakte / *Contacts* / *Contacts*: 2.1: MC 2,5 gedreht / *machined* / *décolleté*

1.8 EPIC® M C

Einsätze / Inserts / Inserts

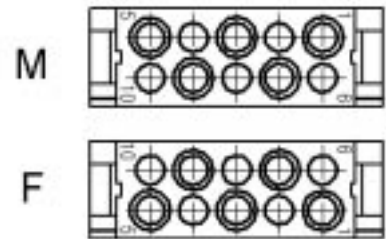

Modul: 10-polig / Module: 10-contacts / Module: 10-contacts

Artikel <i>part</i> <i>article</i>	Version <i>version</i> <i>version</i>	Art. Nr. <i>part No.</i> <i>N° art.</i>	Kontakte <i>contacts</i> <i>contacts</i>	Bemessungsspannung <i>rated voltage</i> <i>tension nominale</i>	Bemessungsstrom <i>rated current</i> <i>courant nominale</i>
MCS 10 CM	Stift / <i>male</i> / <i>mâle</i>	10382400*	10	250 V	10 A
MCB 10 CM	Buchse / <i>female</i> / <i>femelle</i>	10382500*	10	250 V	10 A

Rahmen / *Frames* / *Cadre*: MCR 6/10/16/24

Kontakte / *Contacts* / *Contacts*: 2.1: H-D 1,6 gedreht / *machined* / *décolleté*

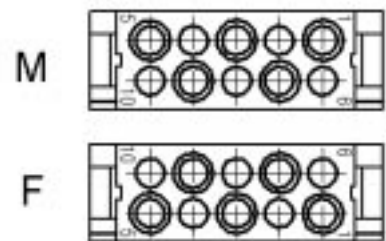

Modul: 10-polig / Module: 10-contacts / Module: 10-contacts

Artikel <i>part</i> <i>article</i>	Version <i>version</i> <i>version</i>	Art. Nr. <i>part No.</i> <i>N° art.</i>	Kontakte <i>contacts</i> <i>contacts</i>	Bemessungsspannung <i>rated voltage</i> <i>tension nominale</i>	Bemessungsstrom <i>rated current</i> <i>courant nominale</i>
MCS 10 CG	Stift / <i>male</i> / <i>mâle</i>	10383400	10	250 V	10 A
MCB 10 CG	Buchse / <i>female</i> / <i>femelle</i>	10383500	10	250 V	10 A

Rahmen / *Frames* / *Cadre*: MCR 6/10/16/24

Kontakte / *Contacts* / *Contacts*: 2.1: HD 1,6 gestanz / *stamped* / *estampé*

1.8 EPIC® M C

Einsätze / Inserts / Inserts

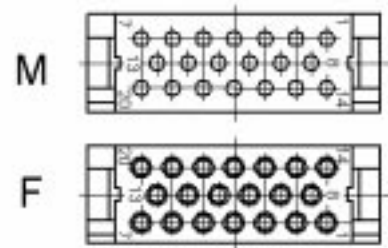

Modul: 20-polig / Module: 20-contacts / Module: 20-contacts

Artikel <i>part</i> <i>article</i>	Version <i>version</i> <i>version</i>	Art. Nr. <i>part No.</i> <i>N° art.</i>	Kontakte <i>contacts</i> <i>contacts</i>	Bemessungsspannung <i>rated voltage</i> <i>tension nominale</i>	Bemessungsstrom <i>rated current</i> <i>courant nominale</i>
MCS 20 CG	Stift / <i>male</i> / <i>mâle</i>	10383600*	20	63 V	5 A
MCB 20 CG	Buchse / <i>female</i> / <i>femelle</i>	10383700*	20	63 V	5 A

Rahmen / *Frames* / *Cadre*: MCR 6/10/16/24

Kontakte / *Contacts* / *Contacts*: 2.1: M-D 1,0 gestanz / *stamped* / *estampé*

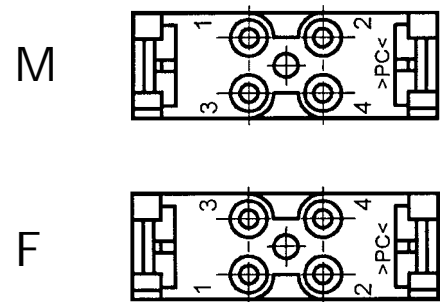

Modul: Käfigzugfeder / Module: Cage clamp / Module: Lame de pression

Artikel <i>part</i> <i>article</i>	Version <i>version</i> <i>version</i>	Art. Nr. <i>part No.</i> <i>N° art.</i>	Kontakte <i>contacts</i> <i>contacts</i>	Anschlußquerschnitt <i>wire gauge</i> <i>section</i>	Bemessungsspannung <i>rated voltage</i> <i>tension nominale</i>	Bemessungsstrom <i>rated current</i> <i>courant nominale</i>
MCS 4 F	Stift / <i>male</i> / <i>mâle</i>	10399600*	4	eindrähtig / <i>single wire</i> / <i>fil unique</i> : 4,0mm ² feindrähtig / <i>fine wire</i> / <i>fil multiple</i> : 2,5mm ²	400 V	16 A
MCB 4 F	Buchse / <i>female</i> / <i>femelle</i>	10399700*	4	eindrähtig / <i>single wire</i> / <i>fil unique</i> : 4,0mm ² feindrähtig / <i>fine wire</i> / <i>fil multiple</i> : 2,5mm ²	400 V	16 A

Rahmen / *Frames* / *Cadre*: MCR 6/10/16/24

1.8 EPIC® M C

Einsätze / Inserts / Inserts



M

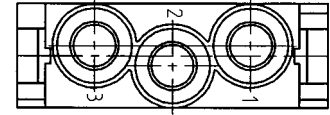

F

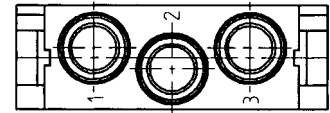

Modul: Hochspannung / module: high voltage / module: haute tension

Artikel <i>part</i> <i>article</i>	Version <i>version</i> <i>version</i>	Art. Nr. <i>part No.</i> <i>N° art.</i>	Kontakte <i>contacts</i> <i>contacts</i>	Bemessungsspannung <i>rated voltage</i> <i>tension nominale</i>	Bemessungsstrom <i>rated current</i> <i>courant nominale</i>
MCS 3 CM-HV	Stift / <i>male</i> / <i>mâle</i>	10399800*	3	1000 V	50 A
MCB 3 CM-HV	Buchse / <i>female</i> / <i>femelle</i>	10399900*	3	1000 V	50 A

Rahmen / *Frames* / *Cadre*: MCR 6/10/16/24

Kontakte / *Contacts* / *Contacts*: 2.1: MC 3,6 gedreht / *machined* / *décolleté*



Modüllösewerkzeug / Module removal tool / Outille de demontage

Artikel <i>part</i> <i>article</i>	Art. Nr. <i>part No.</i> <i>N° art.</i>
Modüllösewerkzeug / <i>Module removal tool</i> / <i>Outille de demontage</i>	11171200*

1.8 EPIC® M C

Einsätze / Inserts / Inserts

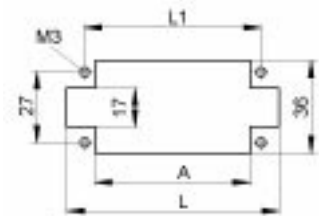
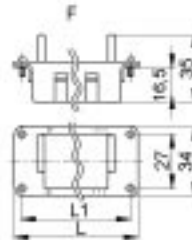
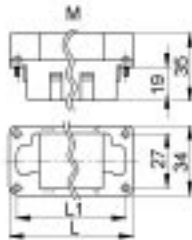
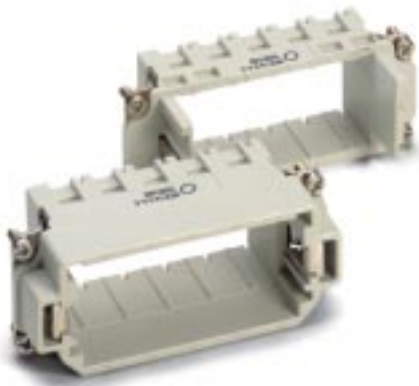

Montageausschnitt
Panel cut-out
Découpe de montage

Rahmen für Module / Frames for modules / Cadre pour modules

MCR 6

Artikel <i>part</i> <i>article</i>	Version <i>version</i> <i>version</i>	Art. Nr. <i>part No.</i> <i>N° art.</i>	Anzahl der Module <i>number of modules</i> <i>nombre de modules</i>	L	L1
MCR 6 S	Stift / <i>male</i> / <i>mâle</i>	10381000*	2	51	44
MCR 6 B	Buchse / <i>female</i> / <i>femelle</i>	10381100*	2	51	44

Gehäuse / *Housings* / *Boîtiers*: 3.2: H-B 6
Module / *Modules* / *modules*: alle / *all* / *tous*

MCR 10

Artikel <i>part</i> <i>article</i>	Version <i>version</i> <i>version</i>	Art. Nr. <i>part No.</i> <i>N° art.</i>	Anzahl der Module <i>number of modules</i> <i>nombre de modules</i>	L	L1
MCR 10 S	Stift / <i>male</i> / <i>mâle</i>	10381200*	3	64	57
MCR 10 B	Buchse / <i>female</i> / <i>femelle</i>	10381300*	3	64	57

Gehäuse / *Housings* / *Boîtiers*: 3.2: H-B 10
Module / *Modules* / *modules*: alle / *all* / *tous*

MCR 16

Artikel <i>part</i> <i>article</i>	Version <i>version</i> <i>version</i>	Art. Nr. <i>part No.</i> <i>N° art.</i>	Anzahl der Module <i>number of modules</i> <i>nombre de modules</i>	L	L1
MCR 16 S	Stift / <i>male</i> / <i>mâle</i>	10381400*	5	84,5	77,5
MCR 16 B	Buchse / <i>female</i> / <i>femelle</i>	10381500*	5	84,5	77,5

Gehäuse / *Housings* / *Boîtiers*: 3.2: H-B 16
Module / *Modules* / *modules*: alle / *all* / *tous*

MCR 24

Artikel <i>part</i> <i>article</i>	Version <i>version</i> <i>version</i>	Art. Nr. <i>part No.</i> <i>N° art.</i>	Anzahl der Module <i>number of modules</i> <i>nombre de modules</i>	L	L1
MCR 24 S	Stift / <i>male</i> / <i>mâle</i>	10381600*	7	111	104
MCR 24 B	Buchse / <i>female</i> / <i>femelle</i>	10381700*	7	111	104

Gehäuse / *Housings* / *Boîtiers*: 3.2: H-B 24
Module / *Modules* / *modules*: alle / *all* / *tous*

1.9 EPIC® T B

Einsätze / Inserts / Inserts

Die komfortable, übersichtliche Verdrahtung im Schaltschrank jetzt mit einer neuen Serie von CONTACT. Ob gerastet oder verschraubt, Sie sparen Platz. Ein umfangreiches Zubehör rundet das Programm ab.

Easy-to-follow, convenient wiring in the control panel, now with a new series from CONTACT. Whether snapped or screwed in, you will save space. An extensive series of accessories completes the range.

Câblez vos armoires électriques de façon claire et en toute tranquillité avec la nouvelle série de bornier CONTACT. Montage à enclenchement ou à vis – vous gagnez de la place. Une gamme complétée par de nombreux accessoires.



1.9 EPIC® T B

Einsätze / Inserts / Inserts

Technische Daten:

	TB-H-BE	TB-H-D
• Kontaktzahlen	6, 10, 16, 24	16, 24, 40, 64 (+ PE)
• Bemessungsspannung	VDE: 380 V UL: 600 V CSA: 600 V SEV: 380 V	VDE: 250 V UL: 600 V CSA: 600 V SEV: 250 V
• Bemessungsstrom	VDE: 10 A UL: 16 A CSA: 16 A SEV: 10 A	VDE: 10 A UL: 7 A CSA: 10 A SEV: 10 A
• Verschmutzungsgrad	3	3
• Prüfspannung:	2,5 kV	2,5 kV
• Temperaturbereich	-40°C - +100°C	-40°C - +115°C
• Leitungsanschluß:		
• Schraubanschluß:	0,5-2,5 mm ²	0,5-1,5 mm ²
• Kontakte	Kupferlegierung, hartversilbert	Kupferlegierung, verzinkt

Technical data

• Number of contacts	6, 10, 16, 24	16, 24, 40, 64 (+ PE)
• Rated voltage	VDE: 380 V UL: 600 V CSA: 600 V SEV: 380 V	VDE: 250 V UL: 600 V CSA: 600 V SEV: 250 V
• Rated current	VDE: 10 A UL: 16 A CSA: 16 A SEV: 10 A	VDE: 10 A UL: 7 A CSA: 10 A SEV: 10 A
• Pollution level	3	3
• Test voltage	2,5 kV	2,5 kV
• Temperature range	-40°C - +100°C	-40°C - +115°C
• Wire termination		
• Screw termination:	0,5-2,5 mm ²	0,5-1,5 mm ²
• Contacts	Copper alloy, silver plated	Copper alloy, tin plated

Caractéristiques techniques:

• Nombre de contacts	6, 10, 16, 24	16, 24, 40, 64 (+ PE)
• Tension nominale	VDE: 380 V UL: 600 V CSA: 600 V SEV: 380 V	VDE: 250 V UL: 600 V CSA: 600 V SEV: 250 V
• Courant nominale:	VDE: 10 A UL: 16 A CSA: 16 A SEV: 10 A	VDE: 10 A UL: 7 A CSA: 10 A SEV: 10 A
• Degré de pollution:	3	3
• Tension d'essai:	2,5 kV	2,5 kV
• Gamme de température:	-40°C - +100°C	-40°C - +115°C
• Raccordement:		
• Raccord à visser	0,5-2,5 mm ²	0,5-1,5 mm ²
• Contacts	Alliage cuivre, argenté	Alliage cuivre, étainé

1.9 EPIC® T B

Einsätze / Inserts / Inserts

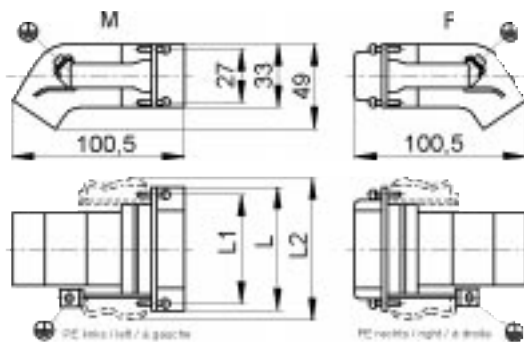
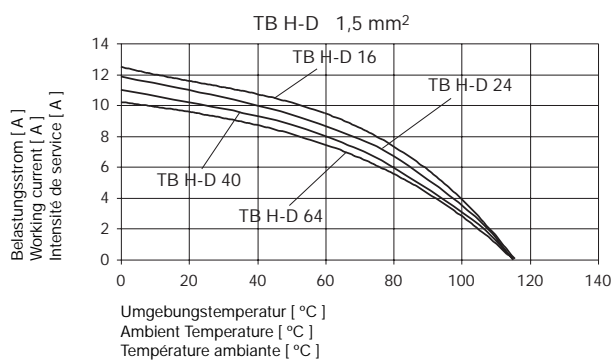
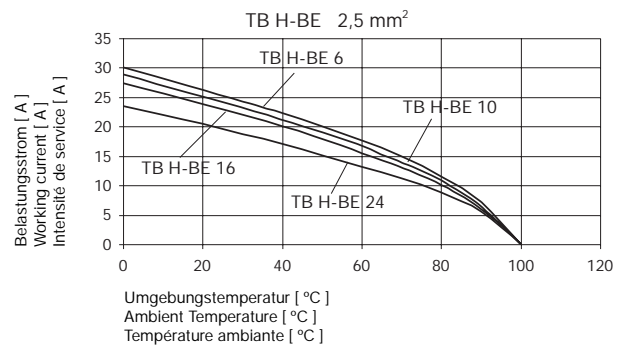
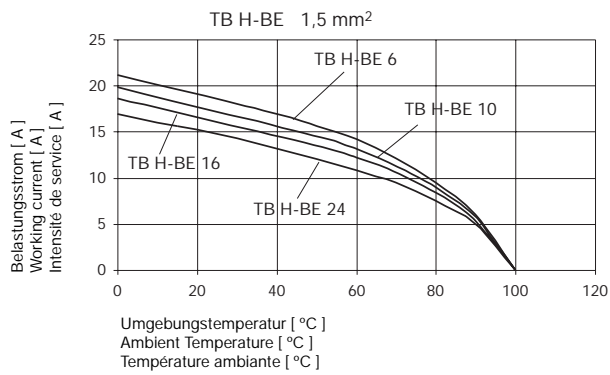

1.9 EPIC® T B

Einsätze / Inserts / Inserts

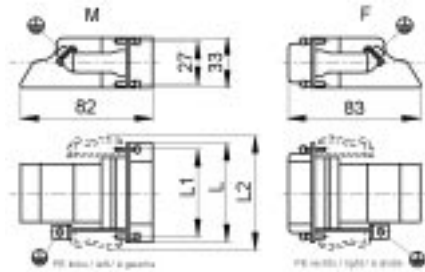

TB-H-BE 6

Artikel <i>part article</i>	Version <i>version version</i>	Art.Nr. <i>part No. N° art.</i>	PE <i>Earth PE</i>	Kontakte <i>contacts contacts</i>	L	L1	L2
TB-H-BE 6 SRE	Stift / <i>male / mâle</i>	70300000	rechts / <i>right / à droite</i>	6	49,8	44	
TB-H-BE 6 BRE	Buchse / <i>female / femelle</i>	70301100	rechts / <i>right / à droite</i>	6	49,8	44	
TB-H-BE 6 SLI	Stift / <i>male / mâle</i>	70301000	links / <i>left / à gauche</i>	6	49,8	44	
TB-H-BE 6 BLI	Buchse / <i>female / femelle</i>	70300100	links / <i>left / à gauche</i>	6	49,8	44	

Gehäuse / *Housings / Boîtiers*:
3.2: H-B 6 AG

Ansicht anschlußseitig
*View from cable side
Vue côté raccordement*

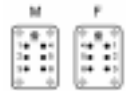

TB-H-BE 6: rastbar / *snap-in / à enclenchement*

Artikel <i>part article</i>	Version <i>version version</i>	Art.Nr. <i>part No. N° art.</i>	PE <i>Earth PE</i>	Kontakte <i>contacts contacts</i>	L	L1	L2
TB-H-BE 6 SRE-RA	Stift / <i>male / mâle</i>	70300500	rechts / <i>right / à droite</i>	6	49,8	44	60
TB-H-BE 6 BRE-RA	Buchse / <i>female / femelle</i>	70301600	rechts / <i>right / à droite</i>	6	49,8	44	60
TB-H-BE 6 SLI-RA	Stift / <i>male / mâle</i>	70301500	links / <i>left / à gauche</i>	6	49,8	44	60
TB-H-BE 6 BLI-RA	Buchse / <i>female / femelle</i>	70300600	links / <i>left / à gauche</i>	6	49,8	44	60

Gehäuse / *Housings / Boîtiers*:
1.9: H-B 6 AG-RA

Ansicht anschlußseitig
*View from cable side
Vue côté raccordement*



TB-H-BE 10

Artikel <i>part article</i>	Version <i>version version</i>	Art.Nr. <i>part No. N° art.</i>	PE <i>Earth PE</i>	Kontakte <i>contacts contacts</i>	L	L1	L2
TB-H-BE 10 SRE	Stift / <i>male / mâle</i>	70302000	rechts / <i>right / à droite</i>	10	63,2	57	
TB-H-BE 10 BRE	Buchse / <i>female / femelle</i>	70303100	rechts / <i>right / à droite</i>	10	63,2	57	
TB-H-BE 10 SLI	Stift / <i>male / mâle</i>	70303000	links / <i>left / à gauche</i>	10	63,2	57	
TB-H-BE 10 BLI	Buchse / <i>female / femelle</i>	70302100	links / <i>left / à gauche</i>	10	63,2	57	

Gehäuse / *Housings / Boîtiers*:
3.2: H-B 10 AG

Ansicht anschlußseitig
*View from cable side
Vue côté raccordement*

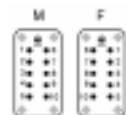

1.9 EPIC® T B

Einsätze / Inserts / Inserts

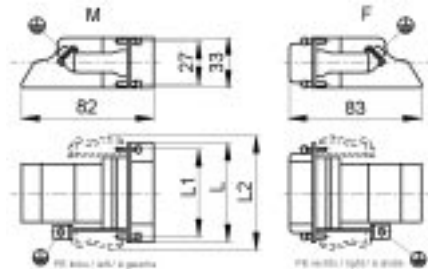

TB-H-BE 10: rastbar / snap-in / à enclenchement

Artikel <i>part</i> <i>article</i>	Version <i>version</i> <i>version</i>	Art.Nr. <i>part No.</i> <i>N° art.</i>	PE <i>Earth</i> <i>PE</i>	Kontakte <i>contacts</i> <i>contacts</i>	L	L1	L2
TB-H-BE 10 SRE-RA	Stift / male / mâle	70302500	rechts / right / à droite	10	63,2	57	73
TB-H-BE 10 BRE-RA	Buchse / female / femelle	70303600	rechts / right / à droite	10	63,2	57	73
TB-H-BE 10 SLI-RA	Stift / male / mâle	70303500	links / left / à gauche	10	63,2	57	73
TB-H-BE 10 BLI-RA	Buchse / female / femelle	70302600	links / left / à gauche	10	63,2	57	73

Gehäuse / Housings / Boîtiers:
1.9: H-B 10 AG-RA

Ansicht anschlußseitig
View from cable side
Vue côté raccordement

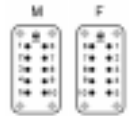

TB-H-BE 16

Artikel <i>part</i> <i>article</i>	Version <i>version</i> <i>version</i>	Art.Nr. <i>part No.</i> <i>N° art.</i>	PE <i>Earth</i> <i>PE</i>	Kontakte <i>contacts</i> <i>contacts</i>	L	L1	L2
TB-H-BE 16 SRE	Stift / male / mâle	70304000	rechts / right / à droite	16	83,3	77,5	
TB-H-BE 16 BRE	Buchse / female / femelle	70305100	rechts / right / à droite	16	83,3	77,5	
TB-H-BE 16 SLI	Stift / male / mâle	70305000	links / left / à gauche	16	83,3	77,5	
TB-H-BE 16 BLI	Buchse / female / femelle	70304100	links / left / à gauche	16	83,3	77,5	

Gehäuse / Housings / Boîtiers:
3.2: H-B 16 AG

Ansicht anschlußseitig
View from cable side
Vue côté raccordement

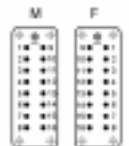

TB-H-BE 16: rastbar / snap-in / à enclenchement

Artikel <i>part</i> <i>article</i>	Version <i>version</i> <i>version</i>	Art.Nr. <i>part No.</i> <i>N° art.</i>	PE <i>Earth</i> <i>PE</i>	Kontakte <i>contacts</i> <i>contacts</i>	L	L1	L2
TB-H-BE 16 SRE-RA	Stift / male / mâle	70304500	rechts / right / à droite	16	83,3	77,5	83
TB-H-BE 16 BRE-RA	Buchse / female / femelle	70305600	rechts / right / à droite	16	83,3	77,5	83
TB-H-BE 16 SLI-RA	Stift / male / mâle	70305500	links / left / à gauche	16	83,3	77,5	83
TB-H-BE 16 BLI-RA	Buchse / female / femelle	70304600	links / left / à gauche	16	83,3	77,5	83

Gehäuse / Housings / Boîtiers:
1.9: H-B 16 AG-RA

Ansicht anschlußseitig
View from cable side
Vue côté raccordement

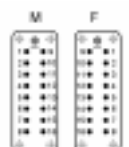

1.9 EPIC® T B

Einsätze / Inserts / Inserts

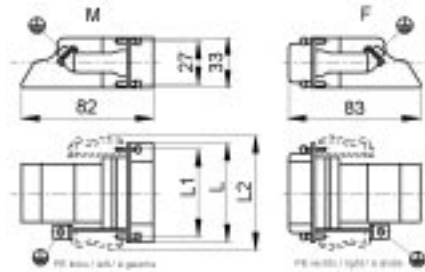

TB-H-BE 24

Artikel <i>part article</i>	Version <i>version version</i>	Art.Nr. <i>part No. N° art.</i>	PE <i>Earth PE</i>	Kontakte <i>contacts contacts</i>	L	L1	L2
TB-H-BE 24 SRE	Stift / <i>male / mâle</i>	70306000	rechts / <i>right / à droite</i>	24	110,1	104	
TB-H-BE 24 BRE	Buchse / <i>female / femelle</i>	70307100	rechts / <i>right / à droite</i>	24	110,1	104	
TB-H-BE 24 SLI	Stift / <i>male / mâle</i>	70307000	links / <i>left / à gauche</i>	24	110,1	104	
TB-H-BE 24 BLI	Buchse / <i>female / femelle</i>	70306100	links / <i>left / à gauche</i>	24	110,1	104	

Gehäuse / *Housings / Boîtiers*:
3.2: H-B 24 AG

Ansicht anschlußseitig
*View from cable side
Vue côté raccordement*

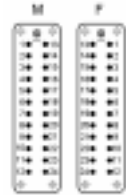

TB-H-BE 24: rastbar / *snap-in / à enclenchement*

Artikel <i>part article</i>	Version <i>version version</i>	Art.Nr. <i>part No. N° art.</i>	PE <i>Earth PE</i>	Kontakte <i>contacts contacts</i>	L	L1	L2
TB-H-BE 24 SRE-RA	Stift / <i>male / mâle</i>	70306500	rechts / <i>right / à droite</i>	24	110,1	104	120
TB-H-BE 24 BRE-RA	Buchse / <i>female / femelle</i>	70307600	rechts / <i>right / à droite</i>	24	110,1	104	120
TB-H-BE 24 SLI-RA	Stift / <i>male / mâle</i>	70307500	links / <i>left / à gauche</i>	24	110,1	104	120
TB-H-BE 24 BLI-RA	Buchse / <i>female / femelle</i>	70306600	links / <i>left / à gauche</i>	24	110,1	104	120

Gehäuse / *Housings / Boîtiers*:
1.9: 3.2: H-B 24 AG-RA

Ansicht anschlußseitig
*View from cable side
Vue côté raccordement*

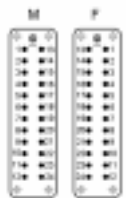

1.9 EPIC® T B

Einsätze / Inserts / Inserts

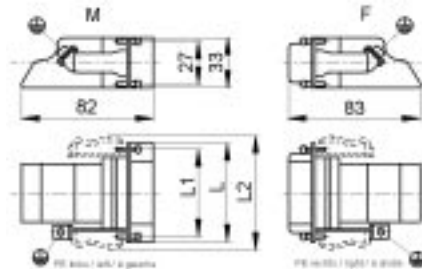

TB-H-D 16

Artikel <i>part article</i>	Version <i>version version</i>	Art.Nr. <i>part No. N° art.</i>	PE <i>Earth PE</i>	Kontakte <i>contacts contacts</i>	L	L1	L2
TB-H-D 16 SRE	Stift / <i>male / mâle</i>	71300000	rechts / <i>right / à droite</i>	16	49,8	44	
TB-H-D 16 BRE	Buchse / <i>female / femelle</i>	71301100	rechts / <i>right / à droite</i>	16	49,8	44	
TB-H-D 16 SLI	Stift / <i>male / mâle</i>	71301000	links / <i>left / à gauche</i>	16	49,8	44	
TB-H-D 16 BLI	Buchse / <i>female / femelle</i>	71300100	links / <i>left / à gauche</i>	16	49,8	44	

Gehäuse / *Housings / Boîtiers:*
3.2: H-B 6 AG

Ansicht anschlußseitig
*View from cable side
Vue côté raccordement*

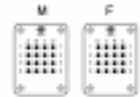

TB-H-D 16: rastbar / *snap-in / à enclenchement*

Artikel <i>part article</i>	Version <i>version version</i>	Art.Nr. <i>part No. N° art.</i>	PE <i>Earth PE</i>	Kontakte <i>contacts contacts</i>	L	L1	L2
TB-H-D 16 SRE-RA	Stift / <i>male / mâle</i>	71300500	rechts / <i>right / à droite</i>	16	49,8	44	58,6
TB-H-D 16 BRE-RA	Buchse / <i>female / femelle</i>	71301600	rechts / <i>right / à droite</i>	16	49,8	44	58,6
TB-H-D 16 SLI-RA	Stift / <i>male / mâle</i>	71301500	links / <i>left / à gauche</i>	16	49,8	44	58,6
TB-H-D 16 BLI-RA	Buchse / <i>female / femelle</i>	71300600	links / <i>left / à gauche</i>	16	49,8	44	58,6

Gehäuse / *Housings / Boîtiers:*
1.9: H-B 6 AG-RA

Ansicht anschlußseitig
*View from cable side
Vue côté raccordement*

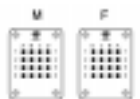

TB-H-D 24

Artikel <i>part article</i>	Version <i>version version</i>	Art.Nr. <i>part No. N° art.</i>	PE <i>Earth PE</i>	Kontakte <i>contacts contacts</i>	L	L1	L2
TB-H-D 24 SRE	Stift / <i>male / mâle</i>	71302000	rechts / <i>right / à droite</i>	24	63,2	57	
TB-H-D 24 BRE	Buchse / <i>female / femelle</i>	71303100	rechts / <i>right / à droite</i>	24	63,2	57	
TB-H-D 24 SLI	Stift / <i>male / mâle</i>	71303000	links / <i>left / à gauche</i>	24	63,2	57	
TB-H-D 24 BLI	Buchse / <i>female / femelle</i>	71302100	links / <i>left / à gauche</i>	24	63,2	57	

Gehäuse / *Housings / Boîtiers:*
3.2: H-B 10 AG

Ansicht anschlußseitig
*View from cable side
Vue côté raccordement*

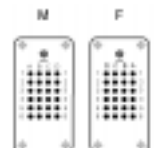

1.9 EPIC® T B

Einsätze / Inserts / Inserts

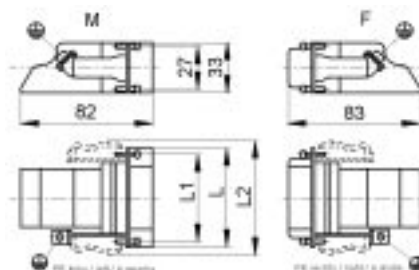

TB-H-D 24: rastbar / snap-in / à enclenchement

Artikel <i>part article</i>	Version <i>version version</i>	Art.Nr. <i>part No. N° art.</i>	PE <i>Earth PE</i>	Kontakte <i>contacts contacts</i>	L	L1	L2
TB-H-D 24 SRE-RA	Stift / male / mâle	71302500	rechts / right / à droite	24	63,2	57	72
TB-H-D 24 BRE-RA	Buchse / female / femelle	71303600	rechts / right / à droite	24	63,2	57	72
TB-H-D 24 SLI-RA	Stift / male / mâle	71303500	links / left / à gauche	24	63,2	57	72
TB-H-D 24 BLI-RA	Buchse / female / femelle	71302600	links / left / à gauche	24	63,2	57	72

Gehäuse / Housings / Boîtiers:
1.9: H-B 10 AG-RA

Ansicht anschlußseitig
*View from cable side
Vue côté raccordement*

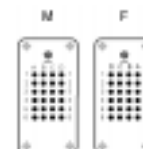

TB-H-D 40

Artikel <i>part article</i>	Version <i>version version</i>	Art.Nr. <i>part No. N° art.</i>	PE <i>Earth PE</i>	Kontakte <i>contacts contacts</i>	L	L1	L2
TB-H-D 40 SRE	Stift / male / mâle	71304000	rechts / right / à droite	40	83,3	77,5	
TB-H-D 40 BRE	Buchse / female / femelle	71305100	rechts / right / à droite	40	83,3	77,5	
TB-H-D 40 SLI	Stift / male / mâle	71305000	links / left / à gauche	40	83,3	77,5	
TB-H-D 40 BLI	Buchse / female / femelle	71304100	links / left / à gauche	40	83,3	77,5	

Gehäuse / Housings / Boîtiers:
3.2 H-B 16 AG

Ansicht anschlußseitig
*View from cable side
Vue côté raccordement*

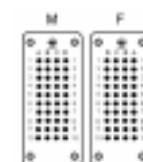

TB-H-D 40: rastbar / snap-in / à enclenchement

Artikel <i>part article</i>	Version <i>version version</i>	Art.Nr. <i>part No. N° art.</i>	PE <i>Earth PE</i>	Kontakte <i>contacts contacts</i>	L	L1	L2
TB-H-D 40 SRE-RA	Stift / male / mâle	71304500	rechts / right / à droite	40	83,3	77,5	92,2
TB-H-D 40 BRE-RA	Buchse / female / femelle	71305600	rechts / right / à droite	40	83,3	77,5	92,2
TB-H-D 40 SLI-RA	Stift / male / mâle	71305500	links / left / à gauche	40	83,3	77,5	92,2
TB-H-D 40 BLI-RA	Buchse / female / femelle	71304600	links / left / à gauche	40	83,3	77,5	92,2

Gehäuse / Housings / Boîtiers:
H-B 16 AG-RA

Ansicht anschlußseitig
*View from cable side
Vue côté raccordement*

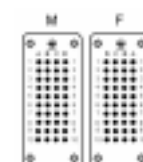

1.9 EPIC® T B

Einsätze / Inserts / Inserts

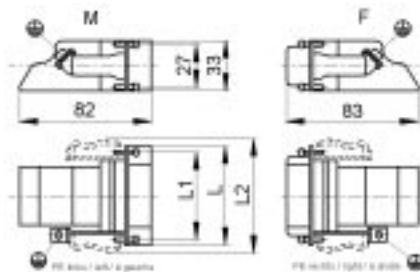

TB-H-D 64

Artikel <i>part article</i>	Version <i>version version</i>	Art.Nr. <i>part No. N° art.</i>	PE <i>Earth PE</i>	Kontakte <i>contacts contacts</i>	L	L1	L2
TB-H-D 64-SRE	Stift / <i>male / mâle</i>	71306000	rechts / <i>right / à droite</i>	64	110,1	104	
TB-H-D 64-BRE	Buchse / <i>female / femelle</i>	71307100	rechts / <i>right / à droite</i>	64	110,1	104	
TB-H-D 64-SLI	Stift / <i>male / mâle</i>	71307000	links / <i>left / à gauche</i>	64	110,1	104	
TB-H-D 64-BLI	Buchse / <i>female / femelle</i>	71306100	links / <i>left / à gauche</i>	64	110,1	104	

Gehäuse / *Housings / Boîtiers*:
3.2 H-B 24 AG

Ansicht anschlußseitig
*View from cable side
Vue côté raccordement*

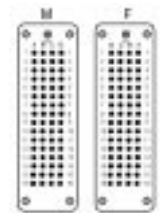

TB-H-D 64: rastbar / *snap-in / à enclenchement*

Artikel <i>part article</i>	Version <i>version version</i>	Art.Nr. <i>part No. N° art.</i>	PE <i>Earth PE</i>	Kontakte <i>contacts contacts</i>	L	L1	L2
TB-H-D 64-SRE-RA	Stift / <i>male / mâle</i>	71306500	rechts / <i>right / à droite</i>	64	110,1	104	119
TB-H-D 64-BRE-RA	Buchse / <i>female / femelle</i>	71307600	rechts / <i>right / à droite</i>	64	110,1	104	119
TB-H-D 64-SLI-RA	Stift / <i>male / mâle</i>	71307500	links / <i>left / à gauche</i>	64	110,1	104	119
TB-H-D 64-BLI-RA	Buchse / <i>female / femelle</i>	71306600	links / <i>left / à gauche</i>	64	110,1	104	119

Gehäuse / *Housings / Boîtiers*:
1.9: H-B 24 AG-RA

Ansicht anschlußseitig
*View from cable side
Vue côté raccordement*

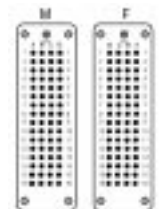

1.9 EPIC® T B

Einsätze / Inserts / Inserts

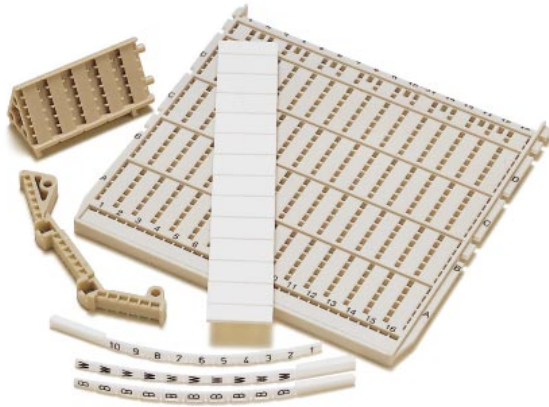

Zubehör: Bezeichnungssystem / Accessories: identification system / Accessoires: Système de marquage

Aufsteckschilder / marking clips / dispositif à fiches

Artikel <i>part article</i>	Art.Nr. <i>part No. N° art.</i>	Beschriftung <i>label marquage</i>
SO 10	70309000	
SF 10	70309100	0...9
SF 10	70309101	1...10
SF 10	70309102	11..20
SG 10	70309200	0...0
SG 10	70309201	1...1
SG 10	70309202	2...2
SG 10	70309203	3...3
SG 10	70309204	4...4
SG 10	70309205	5...5
SG 10	70309206	6...6
SG 10	70309207	7...7
SG 10	70309208	8...8
SG 10	70309209	9...9
SG 10	70309210	A...A
SG 10	70309211	B...B
SG 10	70309212	C...C
SG 10	70309213	D...D
SG 10	70309214	E...E
SG 10	70309215	F...F
SG 10	70309216	G...G
SG 10	70309217	H...H
SG 10	70309218	I...I

Artikel <i>part article</i>	Art.Nr. <i>part No. N° art.</i>	Beschriftung <i>label marquage</i>
SG 10	70309219	J...J
SG 10	70309220	K...K
SG 10	70309221	L...L
SG 10	70309222	M...M
SG 10	70309223	N...N
SG 10	70309224	O...O
SG 10	70309225	P...P
SG 10	70309226	Q...Q
SG 10	70309227	R...R
SG 10	70309228	S...S
SG 10	70309229	T...T
SG 10	70309230	U...U
SG 10	70309231	V...V
SG 10	70309232	W...W
SG 10	70309233	X...X
SG 10	70309234	Y...Y
SG 10	70309235	Z...Z
SG 10	70309236
SG 10	70309237	/.../
SG 10	70309238	-...-
SG 10	70309239	+...+
SG 10	70309240	:...:
SG 10	70309241	=...=

1.9 EPIC® T B

Einsätze / Inserts / Inserts

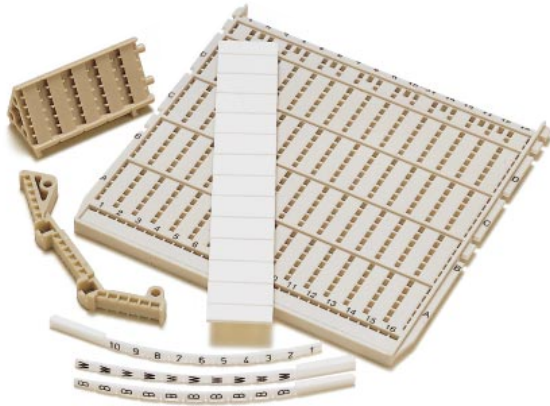

Zubehör: Bezeichnungssystem / Accessories: identification system / Accessoires: Système de marquage

TB-H-BE:

Bezeichnungsträger / Identification carrier / Support de marquage

Artikel / part / article	Art.Nr. / part No. / N° art.	Kontakte / number of contacts / nombre de contacts
BZ 2/3	70308000	3
BZ 2/5	70308010	5
BZ 2/8	70308020	8
BZ 2/12	70308030	12

TB-H-BE/TB-H-D:

zusätzliche Steckverbinderkennzeichnung / Additional plug connector identifier / Marquage complémentaire des connecteurs

Artikel / part / article	Art.Nr. / part No. / N° art.
BZ 3	70308100

TB-H-BE/TB-H-D:

Bezeichnungsplatte / Identification plate / Plaque de marquage

Artikel / part / article	Art.Nr. / part No. / N° art.
DSTV BZP 2	70308200

TB-H-D:

Bezeichnungsschublade / Identification tray / Fenêtre de marquage

Artikel / part / article	Art.Nr. / part No. / N° art.	für Typ / for type / pour type
TB-H-D 16 BZS-SRE	71318000	TB-H-D 16 SRE
TB-H-D 16 BZS-BLI	71318100	TB-H-D 16 BLI
TB-H-D 16 BZS-SLI	71319000	TB-H-D 16 SLI
TB-H-D 16 BZS-BRE	71319100	TB-H-D 16 BRE
TB-H-D 24 BZS-SRE	71318200	TB-H-D 24 SRE
TB-H-D 24 BZS-BLI	71318300	TB-H-D 24 BLI
TB-H-D 24 BZS-SLI	71319200	TB-H-D 24 SLI
TB-H-D 24 BZS-BRE	71319300	TB-H-D 24 BRE
TB-H-D 40 BZS-SRE	71318400	TB-H-D 40 SRE
TB-H-D 40 BZS-BLI	71318500	TB-H-D 40 BLI
TB-H-D 40 BZS-SLI-	71319400	TB-H-D 40 SLI
TB-H-D 40 BZS-BRE	71319500	TB-H-D 40 BRE
TB-H-D 64 BZS-SRE	71318600	TB-H-D 64 SRE
TB-H-D 64 BZS-BLI	71318700	TB-H-D 64 BLI
TB-H-D 64 BZS-SLI-	71319600	TB-H-D 64 SLI
TB-H-D 64 BZS-BRE	71319700	TB-H-D 64 BRE

1.9 EPIC® T B

Einsätze / Inserts / Inserts

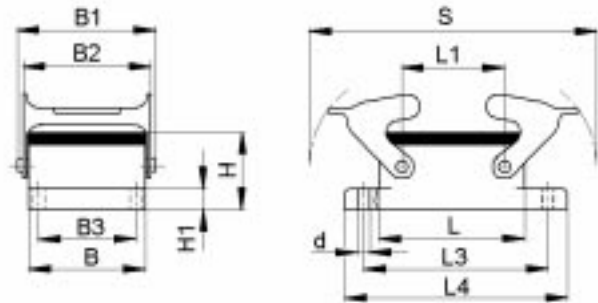

Zubehör: Gehäuse / Accessories: housings / Accessoires: boîtiers

H-B:

Anbaugehäuse rastbar, Querbügel / Panel Mount Base for Back Mounting, Double Locking Lever /
Embase encastrée, à enclenchement, double levier

H-B 10

Artikel part article	Artikel-Nr. part No. N° art.	Eingang entry entrée	Pg	L	L1	L2	L3	L4	B	B1	B2	B3	B4	B5	H	H1	H2	S	d
H-B 10 AG-RA	70032100			73	27		83	93	43	57,8	53	32			27,8	4		116	4,3

Einsätze / Inserts / Inserts:

1.9: TB-H-BE 10 rastbar / snap-in / à enclenchement

1.9: TB-H-D 24 rastbar / snap-in / à enclenchement

H-B 16

Artikel part article	Artikel-Nr. part No. N° art.	Eingang entry entrée	Pg	L	L1	L2	L3	L4	B	B1	B2	B3	B4	B5	H	H1	H2	S	d
H-B 16 AG-RA	70082100			93,3	47,5		103	113	43	57,8	53	32			27,8	4		136,5	4,3

Einsätze / Inserts / Inserts:

1.9: TB-H-BE 16 rastbar / snap-in / à enclenchement

1.9: TB-H-D 40 rastbar / snap-in / à enclenchement

H-B 24

Artikel part article	Artikel-Nr. part No. N° art.	Eingang entry entrée	Pg	L	L1	L2	L3	L4	B	B1	B2	B3	B4	B5	H	H1	H2	S	d
H-B 24 AG-RA	70132100			120	74		130	140	43	57,8	53	32			27,8	4		163	4,3

Einsätze / Inserts / Inserts:

1.9: TB-H-BE 24 rastbar / snap-in / à enclenchement

1.9: TB-H-D 64 rastbar / snap-in / à enclenchement

1.9 EPIC® T B

Einsätze / Inserts / Inserts

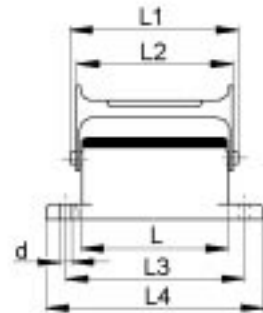
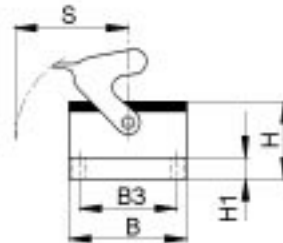

Zubehör: Gehäuse / Accessories: housings / Accessoires: boîtiers

H-B:

Anbaugehäuse rastbar, Längsbügel / Panel Mount Base for Back Mounting, Single Locking Lever /
Embase encastrée, simple levier

H-B 6

Artikel part article	Artikel-Nr. part No. N° art.	Eingang entry entrée	Pg	L	L1	L2	L3	L4	B	B1	B2	B3	B4	B5	H	H1	H2	S	d
H-B 6 AG-RA	70002100			60	74,8	70	70	80	43			32			27,8	4		44	4,3

Einsätze / Inserts / Inserts:

1.9: TB-H-BE 6 rastbar / snap-in / à enclenchement

1.9: TB-H-D 16 rastbar / snap-in / à enclenchement

H-B 10

Artikel part article	Artikel-Nr. part No. N° art.	Eingang entry entrée	Pg	L	L1	L2	L3	L4	B	B1	B2	B3	B4	B5	H	H1	H2	S	d
H-B 10 AG-LB-RA	70032300			73	91	88,5	83	93	43			32			27,8	4		50	4,3

Einsätze / Inserts / Inserts:

1.9: TB-H-BE 10 rastbar / snap-in / à enclenchement

1.9: TB-H-D 24 rastbar / snap-in / à enclenchement

H-B 16

Artikel part article	Artikel-Nr. part No. N° art.	Eingang entry entrée	Pg	L	L1	L2	L3	L4	B	B1	B2	B3	B4	B5	H	H1	H2	S	d
H-B 16 AG-LB-RA	70082300			93,3	111	109,5	103	113	43			32			27,8	4		50	4,3

Einsätze / Inserts / Inserts:

1.9: TB-H-BE 16 rastbar / snap-in / à enclenchement

1.9: TB-H-D 40 rastbar / snap-in / à enclenchement

H-B 24

Artikel part article	Artikel-Nr. part No. N° art.	Eingang entry entrée	Pg	L	L1	L2	L3	L4	B	B1	B2	B3	B4	B5	H	H1	H2	S	d
H-B 24 AG-LB-RA	70132300			120	138	136,5	130	140	43			32			27,8	4		50	4,3

Einsätze / Inserts / Inserts:

1.9: TB-H-BE 24 rastbar / snap-in / à enclenchement

1.9: TB-H-D 64 rastbar / snap-in / à enclenchement

2.1 EPIC® C O N T O O L

Kontakte und Werkzeuge / *Contacts and Tools* / *Contacts et Outillage*



Die passenden Werkzeuge für CONTACT Produkte ermöglichen eine einfache Verarbeitung und garantieren eine zuverlässige elektrische und mechanische Verbindung.

CONTACT can supply tools to satisfy the needs of its total product range guaranteeing reliable electrical and mechanical connections.

Un outillage adapté aux produits CONTACT facilite l'installation et garantit une parfaite liaison électrique et mécanique.



2.1 EPIC® C O N T O O L

Kontakte und Werkzeuge / *Contacts and Tools / Contacts et Outillage*

Technische Daten:

Crimpkontakte:

- Kontakte für Crimpanschluß: gedreht, gestanzt
- Kontakte: Kupferlegierung, versilbert/vergoldet
- Anschlußquerschnitt: 0,08 – 10 mm²
- Kontaktdurchmesser: 1,0 – 3,6 mm

Koax – Kontakte:

- Anschlußtechnik: Crimp, Löt
- Kontakte: Kupferlegierung, vergoldet
- Kabeltypgröße: RG 58
- Wellenwiderstand: 50 Ohm

Lichtwellenleiter – Kontakte:

- Kontakte: Silberlegierung
- Für Fasertyp: Kunststoff-Faser (POF)
Durchmesser: 1mm
Wellenlänge der Diode: 660 nm
- Anschlußtechnik: Crimp

Technical Data:

Crimp Contacts

- *Contacts for crimp termination: machined, stamped*
- *Contacts: copper alloy, silver plated/gold plated*
- *Wire gauge: 0,08 – 10 mm²*
- *Contact diameter: 1,0 – 3,6 mm*

Coax contacts

- *Wire termination: crimp, solder*
- *Contacts: copper alloy, gold plated*
- *Cable size: RG 58*
- *Impedance: 50 Ohm*

Fibre optical contacts:

- *Contacts: silver alloy*
- *For fibre type: plastic fibre*
diameter: 1mm
diode wavelength: 660 nm
- *Wire termination: crimp*

Caractéristiques techniques:

- *Contacts à sertir: décollétés, estampés*
- *Contacts: alliage cuivre, argenté/doré*
- *Raccordement: 0,08 – 10 mm²*
- *Diamètre de contacts: 1,0 – 3,6 mm*

Contact koax

- *Raccordement: à sertir, à souder*
- *Contacts: alliage cuivre, doré*
- *Taille de câbles: RG 58*
- *Impédance: 50 Ohm*

Contacts pour fibre optique

- *Contacts: alliage argente*
- *Type de fibre: fibre en plastique*
diamètre: 1mm
longueur d'onde: 660 nm
- *Raccordement: à sertir*

2.1 EPIC® C O N T O O L

Kontakte und Werkzeuge / *Contacts and Tools / Contacts et Outillage*



Kontakte für Lichtwellenleiter / *Contacts for fibre optics / Contacts pour fibre optique*

Artikel <i>part</i> <i>article</i>	Version <i>version</i> <i>version</i>	Art.Nr. <i>part No.</i> <i>N° art.</i>	Leiterdurchmesser <i>wire diameter</i> <i>diamètre du fil</i>	Abisolierlänge <i>stripping length</i> <i>longueur de dénude</i> <i>(mm)</i>	VPE <i>packing unit</i> <i>conditionnement</i>
LWL	Stift / <i>male / mâle</i>	11214100	1,0 mm POF/FO	19	1
	Buchse / <i>female / femelle</i>	11219100	1,0 mm POF/FO	14	1

Einsätze / *Inserts / Inserts:*

1.8: MCS 10 CM / MCB 10 CM

1.6: H-D 7 für gedrehte Kontakte / *1.6: H-D 7 for machined contacts / 1.6: H-D 7 pour contacts décollétés*



Werkzeuge / *Tools / Outillage*

Artikel <i>part</i> <i>article</i>	Leiterdurchmesser <i>wire diameter</i> <i>diamètre du fil</i>	Art.Nr. <i>part No.</i> <i>N° art.</i>
LWL Montage Set / <i>Fibre optic assembly set / Montage set pour fibre optique</i>	1,0 mm POF/FO	11184700

Einzelartikel / *Single parts / Seule articles*

Artikel <i>part</i> <i>article</i>	für Leiterdurchmesser optische Faser <i>for wire diameter optical fibre</i> <i>diamètre du fil pour fibre optique</i>	Art.Nr. <i>part No.</i> <i>N° art.</i>
Crimpzange / <i>crimping tool / pince à setir</i>	1,0 mm	11184000
Kontaktaufnahme / <i>locator / positionneur</i>		11184100
Faserabisolierer für POF-Kabel <i>stripping tool for fibre optic cable</i> <i>outillage de dénuder pour cable fibre optique</i>		11184200
Messer / <i>knife / couteau</i>		11184300
Polierpapier / <i>polishing paper / papier de polissage</i>		11184400
Polierplatte / <i>polishing plate / planche de polissage</i>		11184500
Lösewerkzeug / <i>removal tool / outil de démontage</i>		11161000*

2.1 EPIC® C O N T O O L

Kontakte und Werkzeuge / *Contacts and Tools / Contacts et Outillage*



H-D / H-DD / MC gedrehte Kontakte - Kontaktdurchmesser 1,6 mm

H-D / H-DD / MC machined contacts - contact diameter 1,6 mm

H-D / H-DD / MC contacts décollétés - contact diamètre 1,6 mm

Artikel <i>part</i> <i>article</i>	Version <i>version</i> <i>version</i>	Art.Nr. <i>part No.</i> <i>N° art.</i>	Leiterquerschnitt <i>wire gauge</i> <i>section</i> (mm ²)	Abisolierlänge <i>stripping length</i> <i>longueur de dénuder</i> (mm)	Oberfläche <i>plating</i> <i>surface</i>	VPE <i>packing unit</i> <i>conditionnement</i>
H-D 1,6	Stift / <i>male</i> / <i>mâle</i>	13162000*	0,14 - 0,37	8,0	Ag	100
gedreht	Buchse / <i>female</i> / <i>femelle</i>	13163000*	0,14 - 0,37	8,0	Ag	100
<i>machined</i>	Stift / <i>male</i> / <i>mâle</i>	13162100*	0,5	8,0	Ag	100
<i>décollété</i>	Buchse / <i>female</i> / <i>femelle</i>	13163100*	0,5	8,0	Ag	100
	Stift / <i>male</i> / <i>mâle</i>	13162200*	0,75 - 1,0	8,0	Ag	100
	Buchse / <i>female</i> / <i>femelle</i>	13163200*	0,75 - 1,0	8,0	Ag	100
	Stift / <i>male</i> / <i>mâle</i>	13162300*	1,5	8,0	Ag	100
	Buchse / <i>female</i> / <i>femelle</i>	13163300*	1,5	8,0	Ag	100
	Stift / <i>male</i> / <i>mâle</i>	13162400*	2,5	5,8	Ag	100
	Buchse / <i>female</i> / <i>femelle</i>	13163400*	2,5	5,8	Ag	100
	Stift / <i>male</i> / <i>mâle</i>	13162500*	0,14 - 0,37	8,0	Au	100
	Buchse / <i>female</i> / <i>femelle</i>	13163500*	0,14 - 0,37	8,0	Au	100
	Stift / <i>male</i> / <i>mâle</i>	13162600*	0,5	8,0	Au	100
	Buchse / <i>female</i> / <i>femelle</i>	13163600*	0,5	8,0	Au	100
	Stift / <i>male</i> / <i>mâle</i>	13162700*	0,75 - 1,0	8,0	Au	100
	Buchse / <i>female</i> / <i>femelle</i>	13163700*	0,75 - 1,0	8,0	Au	100
	Stift / <i>male</i> / <i>mâle</i>	13162800*	1,5	8,0	Au	100
	Buchse / <i>female</i> / <i>femelle</i>	13163800*	1,5	8,0	Au	100

Einsätze / *Inserts* / *Inserts*:

1.8: MCS 10 CM, MCB 10 CM

1.6 / 1.7: H-D / H-DD Einsätze für gedrehte Kontakte

1.6 / 1.7: H-D / H-DD inserts for machined contacts

1.6 / 1.7: H-D / H-DD inserts pour contacts décollétés

2.1 EPIC® C O N T O O L

Kontakte und Werkzeuge / *Contacts and Tools / Contacts et Outillage*

Jetzt neu!
New!
Nouveauté!



Werkzeuge / *Tools / Outillage*

Artikel <i>part article</i>	Leiterquerschnitt <i>wire gauge section</i>	Locator <i>locator insert centreur</i>	Crimpbacken <i>crimp dies machoire</i>	Crimpwerkzeug <i>crimping tool outil de sertissage</i>
Lösewerkzeuge für Kontakte <i>removal tool for contacts outil de demontage pour contacts</i>				11161000*
Crimpzange <i>crimping tool pince à sertir</i>	0,14 - 2,5 mm ²	11147200	11147100	11147000

2.1 EPIC® C O N T O O L

Kontakte und Werkzeuge / *Contacts and Tools / Contacts et Outillage*



MC gedrehte Kontakte - Kontaktdurchmesser 2,5 mm

MC machined contacts - contact diameter 2,5 mm

MC contacts décolletés - contact diamètre 2,5 mm

Artikel <i>part article</i>	Version <i>version version</i>	Art.Nr. <i>part No. N° art.</i>	Leiterquerschnitt <i>wire gauge section (mm²)</i>	Abisolierlänge <i>stripping length longueur de dénuder (mm)</i>	Oberfläche <i>plating surface</i>	VPE <i>packing unit conditionnement</i>
MC 2,5	Stift / <i>male / mâle</i>	11213000	0,5	7,8	Ag	100
gedreht	Buchse / <i>female / femelle</i>	11218000	0,5	7,8	Ag	100
<i>machined</i>	Stift / <i>male / mâle</i>	11213100*	0,75 - 1,0	7,8	Ag	100
<i>décolleté</i>	Buchse / <i>female / femelle</i>	11218100*	0,75 - 1,0	7,8	Ag	100
	Stift / <i>male / mâle</i>	11213200*	1,5	7,8	Ag	100
	Buchse / <i>female / femelle</i>	11218200*	1,5	7,8	Ag	100
	Stift / <i>male / mâle</i>	11213300*	2,5	7,8	Ag	100
	Buchse / <i>female / femelle</i>	11218300*	2,5	7,8	Ag	100
	Stift / <i>male / mâle</i>	11213400*	4,0	7,8	Ag	100
	Buchse / <i>female / femelle</i>	11218400*	4,0	7,8	Ag	100

Einsätze / *Inserts / Inserts:*

1.8: MCS 5 CM, MCB 5 CM

2.1 EPIC® C O N T O O L

Kontakte und Werkzeuge / *Contacts and Tools / Contacts et Outillage*

Jetzt neu!
New!
Nouveauté!



Werkzeuge / *Tools / Outillage*

Artikel <i>part article</i>	Leiterquerschnitt <i>wire gauge section</i>	Art.Nr. <i>part No. N° art.</i>		
			Locator <i>locator insert centreur</i>	Crimpbacken <i>crimp dies machoire</i>
				Crimpwerkzeug <i>crimping tool outil de sertissage</i>
Lösewerkzeuge für Kontakte <i>removal tool for contacts outil de demontage pour contacts</i>				11171000
Crimpzange <i>crimping tool pince à sertir</i>	0,5 - 4,0 mm ²	11147200	11147100	11147000

2.1 EPIC® C O N T O O L

Kontakte und Werkzeuge / *Contacts and Tools / Contacts et Outillage*



H-BE gedrehte Kontakte - Kontaktdurchmesser 2,5 mm

H-BE machined contacts - contact diameter 2,5 mm

H-BE contacts décollétés - contact diamètre 2,5 mm

Artikel <i>part article</i>	Version <i>version version</i>	Art.Nr. <i>part No. N° art.</i>	Leiterquerschnitt <i>wire gauge section (mm²)</i>	Abisolierlänge <i>stripping length longueur de dénuder (mm)</i>	Oberfläche <i>plating surface</i>	VPE <i>packing unit conditionnement</i>
H-BE 2,5	Stift / <i>male / mâle</i>	11190000	0,5	7,4	Ag	100
gedreht	Buchse / <i>female / femelle</i>	11195000	0,5	7,3	Ag	100
<i>machined</i>	Stift / <i>male / mâle</i>	11190100	0,75 - 1,0	7,4	Ag	100
<i>décollété</i>	Buchse / <i>female / femelle</i>	11195100	0,75 - 1,0	7,3	Ag	100
	Stift / <i>male / mâle</i>	11190200*	1,5	7,4	Ag	100
	Buchse / <i>female / femelle</i>	11195200*	1,5	7,3	Ag	100
	Stift / <i>male / mâle</i>	11190300	2,5	7,4	Ag	100
	Buchse / <i>female / femelle</i>	11195300	2,5	7,3	Ag	100
	Stift / <i>male / mâle</i>	11190400	4,0	7,4	Ag	100
	Buchse / <i>female / femelle</i>	11195400	4,0	7,3	Ag	100
	Stift / <i>male / mâle</i>	11192000	0,5	7,4	Au	100
	Buchse / <i>female / femelle</i>	11197000	0,5	7,3	Au	100
	Stift / <i>male / mâle</i>	11192100	0,75 - 1,0	7,4	Au	100
	Buchse / <i>female / femelle</i>	11197100	0,75 - 1,0	7,3	Au	100
	Stift / <i>male / mâle</i>	11192200	1,5	7,4	Au	100
	Buchse / <i>female / femelle</i>	11197200	1,5	7,3	Au	100

Einsätze / *Inserts / Inserts:*

1.8: H-E Modul / *H-E module / module H-E*

1.3: H-BE Einsätze für gedrehte Kontakte

1.3: H-BE inserts for machined contacts

1.3: H-BE inserts pour contacts décollétés

2.1 EPIC® C O N T O O L

Kontakte und Werkzeuge / *Contacts and Tools / Contacts et Outillage*

Jetzt neu!
New!
Nouveauté!



Werkzeuge / *Tools / Outillage*

Artikel <i>part article</i>	Leiterquerschnitt <i>wire gauge section</i>	Locator <i>locator insert centreur</i>	Crimpbacken <i>crimp dies mchoire</i>	Crimpwerkzeug <i>crimping tool outil de sertissage</i>
Crimpzange <i>crimping tool pince à sertir</i>	0,5 - 4,0 mm ²	11147200	11147100	11147000
Lösewerkzeug für Kontakte / H-E Modul (MC 4CM) <i>removal tool for contacts / H-E module (MC 4 CM) outil de demontage pour contacts / module H-E (MC 4 CM)</i>			11182500	

2.1 EPIC® C O N T O O L

Kontakte und Werkzeuge / *Contacts and Tools / Contacts et Outillage*



MC gedrehte Kontakte - Kontaktdurchmesser 3,6 mm

MC machined contacts - contact diameter 3,6 mm

MC contacts décolletés - contact diamètre 3,6 mm

Artikel <i>part</i> <i>article</i>	Version <i>version</i> <i>version</i>	Art.Nr. <i>part No.</i> <i>N° art.</i>	Leiterquerschnitt <i>wire gauge</i> <i>section</i> (mm ²)	Abisolierlänge <i>stripping length</i> <i>longueur de dénuder</i> (mm)	Oberfläche <i>plating</i> <i>surface</i>	VPE <i>packing unit</i> <i>conditionnement</i>
MC 3,6	Stift / <i>male</i> / <i>mâle</i>	11210700	1,5	10,0	Ag	100
gedreht	Buchse / <i>female</i> / <i>femelle</i>	11215700	1,5	10,0	Ag	100
<i>machined</i>	Stift / <i>male</i> / <i>mâle</i>	11210600	2,5	10,0	Ag	100
<i>décolleté</i>	Buchse / <i>female</i> / <i>femelle</i>	11215600	2,5	10,0	Ag	100
	Stift / <i>male</i> / <i>mâle</i>	11210000	4,0	10,0	Ag	100
	Buchse / <i>female</i> / <i>femelle</i>	11215000*	4,0	10,0	Ag	100
	Stift / <i>male</i> / <i>mâle</i>	11210100*	6,0	10,0	Ag	100
	Buchse / <i>female</i> / <i>femelle</i>	11215100*	6,0	10,0	Ag	100
	Stift / <i>male</i> / <i>mâle</i>	11210200	10,0	10,0	Ag	100
	Buchse / <i>female</i> / <i>femelle</i>	11215200	10,0	10,0	Ag	100

Einsätze / *Inserts* / *Inserts*:

1.8: MCS 3 CM / MCB 3 CM

2.1 EPIC® C O N T O O L

Kontakte und Werkzeuge / *Contacts and Tools / Contacts et Outillage*

Jetzt neu!
New!
Nouveauté!



Werkzeuge / *Tools / Outillage*

Artikel <i>part article</i>	Leiterquerschnitt <i>wire gauge section</i>	Art.Nr. <i>part No. N° art.</i>
	Locator <i>locator insert centreur</i>	Crimpbacken <i>crimp dies machoire</i>
Löswerkzeuge für Kontakte <i>removal tool for contacts outil de demontage pour contacts</i>		Crimpwerkzeug <i>crimping tool outil de sertissage</i>
		11171100*
Crimpzange <i>crimping tool pince à sertir</i>	1,5 - 2,5 mm ² 4,0 - 10,0 mm ²	11147210 11147110 11147120
		11147000

2.1 EPIC® C O N T O O L

Kontakte und Werkzeuge / *Contacts and Tools / Contacts et Outillage*



H-D / MC gestanzte Kontakte - Kontaktdurchmesser 1,6 mm

H-D / MC stamped contacts - contact diameter 1,6 mm

H-D / MC contacts estampés - contact diamètre 1,6 mm

Artikel <i>part</i> <i>article</i>	Version <i>version</i> <i>version</i>	Art.Nr. <i>part No.</i> <i>N° art.</i>	Leiterquerschnitt <i>wire gauge</i> <i>section</i> (mm ²)	Abisolierlänge <i>stripping length</i> <i>longueur de dénuder</i> (mm)	Oberfläche <i>plating</i> <i>surface</i>	VPE <i>packing unit</i> <i>conditionnement</i>
H-D 1,6	Stift / <i>male</i> / <i>mâle</i>	11241100	0,14 - 0,5	2,5 + 0,5	Ag	100
gestanzt	Buchse / <i>female</i> / <i>femelle</i>	11231100	0,14 - 0,5	2,5 + 0,5	Ag	100
<i>stamped</i>	Stift / <i>male</i> / <i>mâle</i>	11221000	0,5 - 1,5	3,5 + 0,5	Ag	100
<i>estampé</i>	Buchse / <i>female</i> / <i>femelle</i>	11236100	0,5 - 1,5	3,5 + 0,5	Ag	100
	Stift / <i>male</i> / <i>mâle</i>	11223500	1,5 - 2,5	3,5 + 0,5	Ag	100
	Buchse / <i>female</i> / <i>femelle</i>	11228500	1,5 - 2,5	3,5 + 0,5	Ag	100
	Stift / <i>male</i> / <i>mâle</i>	11243100	0,14 - 0,5	2,5 + 0,5	Au	100
	Buchse / <i>female</i> / <i>femelle</i>	11233100	0,14 - 0,5	2,5 + 0,5	Au	100
	Stift / <i>male</i> / <i>mâle</i>	11221300	0,5 - 1,5	3,5 + 0,5	Au	100
	Buchse / <i>female</i> / <i>femelle</i>	11238100	0,5 - 1,5	3,5 + 0,5	Au	100

Einsätze / *Inserts* / *Inserts*:

1.8: MCS 10 CG / MCB 10 CG

1.6: H-D Einsätze für gestanzte Kontakte

1.6: H-D inserts for stamped contacts

1.6: H-D inserts pour contacts estampés

2.1 EPIC® C O N T O O L

Kontakte und Werkzeuge / *Contacts and Tools / Contacts et Outillage*

Jetzt neu!
New!
Nouveauté!



Werkzeuge / *Tools / Outillage*

Artikel <i>part article</i>	Leiterquerschnitt <i>wire gauge section</i>	Art.Nr. <i>part No. N° art.</i>
	Locator <i>locator insert centreur</i>	Crimpbacken <i>crimp dies machoire</i>
Löswerkzeuge für Kontakte <i>removal tool for contacts outil de demontage pour contacts</i>		Crimpwerkzeug <i>crimping tool outil de sertissage</i>
		11161000*
Crimpzange <i>crimping tool pince à sertir</i>	0,14 - 0,5 mm ² 0,5 - 1,5 mm ² 1,5 - 2,5 mm ²	11147300 11147170 11147180 11147190
		11147000

2.1 EPIC® C O N T O O L

Kontakte und Werkzeuge / *Contacts and Tools / Contacts et Outillage*



MC gestanzte Kontakte - Kontaktdurchmesser 2,5 mm

MC stamped contacts - contact diameter 2,5 mm

MC contacts estampés - contact diamètre 2,5 mm

Artikel <i>part</i> <i>article</i>	Version <i>version</i> <i>version</i>	Art.Nr. <i>part No.</i> <i>N° art.</i>	Leiterquerschnitt <i>wire gauge</i> <i>section</i> (mm ²)	Abisolierlänge <i>stripping length</i> <i>longueur de dénuder</i> (mm)	Oberfläche <i>plating</i> <i>surface</i>	VPE <i>packing unit</i> <i>conditionnement</i>
MC 2,5	Stift / <i>male</i> / <i>mâle</i>	11201000	0,5 - 1,5 mm ²	3,5 + 0,5	Ag	100
gestanzt	Buchse / <i>female</i> / <i>femelle</i>	11205000	0,5 - 1,5 mm ²	3,5 + 0,5	Ag	100
<i>stamped</i>	Stift / <i>male</i> / <i>mâle</i>	11202000	1,5 - 2,5 mm ²	3,5 + 0,5	Ag	100
<i>estampé</i>	Buchse / <i>female</i> / <i>femelle</i>	11206000	1,5 - 2,5 mm ²	3,5 + 0,5	Ag	100

Einsätze / *Inserts* / *Inserts*:

1.8: MCS 5 CG / MCB 5 CG

2.1 EPIC® C O N T O O L

Kontakte und Werkzeuge / *Contacts and Tools / Contacts et Outillage*

Jetzt neu!
New!
Nouveauté!



Werkzeuge / *Tools / Outillage*

Artikel <i>part article</i>	Leiterquerschnitt <i>wire gauge section</i>	Art.Nr. <i>part No. N° art.</i>
	Locator <i>locator insert centreur</i>	Crimpbacken <i>crimp dies machoire</i>
Löswerkzeuge für Kontakte <i>removal tool for contacts outil de demontage pour contacts</i>		Crimpwerkzeug <i>crimping tool outil de sertissage</i>
		11160000
Crimpzange <i>crimping tool pince à sertir</i>	0,5 - 1,5 mm ² 1,5 - 2,5 mm ²	11147300 11147180 11147190
		11147000

2.1 EPIC® C O N T O O L

Kontakte und Werkzeuge / *Contacts and Tools / Contacts et Outillage*



MC / M-D gestanzte Band-Kontakte - Kontaktdurchmesser 1,0 mm

MC / M-D stamped contacts on reel - contact diameter 1,0 mm

MC / M-D contacts estampés en bande - contact diamètre 1,0 mm

Artikel <i>part</i> <i>article</i>	Version <i>version</i> <i>version</i>	Art.Nr. <i>part No.</i> <i>N° art.</i>	Leiterquerschnitt <i>wire gauge</i> <i>section</i> (mm ²)	Abisolierlänge <i>stripping length</i> <i>longueur de</i> <i>dénuder</i> (mm)	Oberfläche <i>plating</i> <i>surface</i>	Kontaktzuführung <i>contact feeding</i> <i>indroduction</i>	VPE <i>packing unit</i> <i>condition-</i> <i>nement</i>
M-D 1,0	Stift / <i>male / mâle</i>	11302500	0,08 - 0,2	2,5 + 0,5	Au	links / <i>left / gauche</i>	300
gestanzt	Buchse / <i>female / femelle</i>	11302700	0,08 - 0,2	2,5 + 0,5	Au	links / <i>left / gauche</i>	300
stamped	Stift / <i>male / mâle</i>	11302600	0,2 - 0,52	2,5 + 0,5	Au	links / <i>left / gauche</i>	300
estampé	Buchse / <i>female / femelle</i>	11302800	0,2 - 0,52	2,5 + 0,5	Au	links / <i>left / gauche</i>	300

Einsätze / *Inserts / Inserts*:
MCS 20 CG / MCB 20 CG

2.1 EPIC® C O N T O O L

Kontakte und Werkzeuge / *Contacts and Tools / Contacts et Outillage*



Werkzeuge / *Tools / Outillage*

Artikel <i>part</i> <i>article</i>	Leiterquerschnitt <i>wire gauge</i> <i>section</i>	Art.Nr. <i>part No.</i> <i>N° art.</i>	
	Locator <i>locator</i> <i>insert centreur</i>	Crimpbacken <i>crimp dies</i> <i>machoire</i>	Crimpwerkzeug <i>crimping tool</i> <i>outil de sertissage</i>
Lösewerkzeuge für Kontakte <i>removal tool for contacts</i> <i>outil de demontage pour contacts</i>			11132500
Crimpzange <i>crimping tool</i> <i>pince à sertir</i>	0,08 - 0,56 mm ²		11158400

2.1 EPIC® C O N T O O L

Kontakte und Werkzeuge / *Contacts and Tools / Contacts et Outillage*



H-D / MC gestanzte Band-Kontakte - Kontaktdurchmesser 1,6 mm

H-D / MC stamped contacts on reel - contact diameter 1,6 mm

H-D / MC contacts estampés en bande - contact diamètre 1,6 mm

Artikel <i>part article</i>	Version <i>version version</i>	Art.Nr. <i>part No. N° art.</i>	Leiterquerschnitt <i>wire gauge section</i> (mm ²)	Abisolierlänge <i>stripping length longueur de dénuder</i> (mm)	Oberfläche <i>plating surface</i>	Kontaktzuführung <i>contact feeding indroduction</i>	VPE <i>packing unit condition- nement</i>
H-D 1,6	Stift / <i>male / mâle</i>	11240700	0,14 - 0,5	2,5 + 0,5	Ag	links / <i>left / gauche</i>	200
gestanzt	Buchse / <i>female / femelle</i>	11230700	0,14 - 0,5	2,5 + 0,5	Ag	links / <i>left / gauche</i>	200
stamped	Stift / <i>male / mâle</i>	11220700	0,5 - 1,5	3,5 + 0,5	Ag	links / <i>left / gauche</i>	200
estampé	Buchse / <i>female / femelle</i>	11235700	0,5 - 1,5	3,5 + 0,5	Ag	links / <i>left / gauche</i>	200
	Stift / <i>male / mâle</i>	11223000	1,5 - 2,5	3,5 + 0,5	Ag	links / <i>left / gauche</i>	200
	Buchse / <i>female / femelle</i>	11228000	1,5 - 2,5	3,5 + 0,5	Ag	links / <i>left / gauche</i>	200

Einsätze / *Inserts / Inserts:*

1.8: MCS 10 CG / MCB 10 CG

1.6: H-D Einsätze für gestanzte Kontakte

1.6: H-D inserts for stamped contacts

1.6: H-D inserts pour contacts estampés

2.1 EPIC® C O N T O O L

Kontakte und Werkzeuge / *Contacts and Tools / Contacts et Outillage*



Werkzeuge / *Tools / Outillage*

Artikel <i>part article</i>	Leiterquerschnitt <i>wire gauge section</i>	Art.Nr. <i>part No. N° art.</i>
	Locator <i>locator insert centreur</i>	Crimpbacken <i>crimp dies machoire</i>
Löswerkzeuge für Kontakte <i>removal tool for contacts outil de demontage pour contacts</i>		Crimpwerkzeug <i>crimping tool outil de sertissage</i>
		11161000*
Crimpzange <i>crimping tool pince à sertir</i>	0,14 - 0,5 mm ² 0,5 - 1,5 mm ² 1,5 - 2,5 mm ²	11153600 11153700 11153800
		11153500

2.1 EPIC® C O N T O O L

Kontakte und Werkzeuge / *Contacts and Tools / Contacts et Outillage*



MC gestanzte Band-Kontakte - Kontaktdurchmesser 2,5 mm

MC stamped contacts on reel - contact diameter 2,5 mm

MC contacts estampés en bande - contact diamètre 2,5 mm

Artikel <i>part article</i>	Version <i>version version</i>	Art.Nr. <i>part No. N° art.</i>	Leiterquerschnitt <i>wire gauge section</i> (mm ²)	Abisolierlänge <i>stripping length longueur de dénuder</i> (mm)	Oberfläche <i>plating surface</i>	Kontaktzuführung <i>contact feeding introduction</i>	VPE <i>packing unit condition- nement</i>
MC 2,5	Stift / <i>male / mâle</i>	11208000	0,5 - 1,5	3,5 + 0,5	Ag	links / <i>left / gauche</i>	200
gestanzt	Buchse / <i>female / femelle</i>	11209000	0,14 - 0,5	3,5 + 0,5	Ag	links / <i>left / gauche</i>	200
stamped	Stift / <i>male / mâle</i>	11208500	1,5 - 2,5	3,5 + 0,5	Ag	links / <i>left / gauche</i>	200
estampé	Buchse / <i>female / femelle</i>	11209500	1,5 - 2,5	3,5 + 0,5	Ag	links / <i>left / gauche</i>	200

Einsätze / *Inserts / Inserts:*

1.8: MCS 5 CG / MCB 5 CG

2.1 EPIC® C O N T O O L

Kontakte und Werkzeuge / *Contacts and Tools / Contacts et Outillage*



Werkzeuge / *Tools / Outillage*

Artikel <i>part article</i>	Leiterquerschnitt <i>wire gauge section</i>	Art.Nr. <i>part No. N° art.</i>	Locator <i>locator insert centreur</i>	Crimpbacken <i>crimp dies machoire</i>	Crimpwerkzeug <i>crimping tool outil de sertissage</i>
Lösewerkzeuge für Kontakte <i>removal tool for contacts outil de demontage pour contacts</i>					11160000
Crimpzange <i>crimping tool pince à sertir</i>	0,5 - 1,5 mm ² 1,5 - 2,5 mm ²	11153700 11153800			11153500

2.1 EPIC® C O N T O O L

Kontakte und Werkzeuge / *Contacts and Tools / Contacts et Outillage*

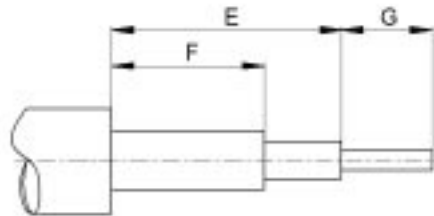

KOAX-Kontakte

Coax contacts

Contacts coax

Artikel <i>part article</i>	Version <i>version version</i>	Art.Nr. <i>part No. N° art.</i>	Leiterquerschnitt <i>wire gauge section</i>	E	F	G	Oberfläche <i>plating surface</i>	VPE <i>packing unit conditionnement</i>
KOAX	Stift / <i>male / mâle</i>	11214200	RG 58	9,5	7,9	2	Au	1
	Buchse / <i>female / femelle</i>	11219200	RG 58	9,5	7,9	2	Au	1

Einsätze / *Inserts / Inserts:*

1.8: MCS 5 KOAX / MCB 5 KOAX

2.1 EPIC® C O N T O O L

Kontakte und Werkzeuge / *Contacts and Tools / Contacts et Outillage*

Jetzt neu !
New !
Nouveauté !



Werkzeuge / *Tools / Outillage*

Artikel <i>part article</i>	Kabelgröße <i>wire size grandeur du fil</i>	Art.Nr. <i>part No. N° art.</i>	
	Locator <i>locator insert centreur</i>	Crimpbacken <i>crimp dies machoire</i>	Crimpwerkzeug <i>crimping tool outil de sertissage</i>
Löswerkzeuge für Kontakte <i>removal tool for contacts outil de demontage pour contacts</i>			11171100
Crimpzange <i>crimping tool pince à sertir</i>	RG58	11147130	11147000

3.1 EPIC® D A - V I N C I H - A

Gehäuse / Housing / Boîtiers

Qualität und Funktionalität sind maßgebend für die Gehäuseserie H-A. Diese Rechtecksteckverbinder überzeugen durch eine kompakte Gehäuseform und eine innovative Bügelgeneration. Dazu bieten die Gehäuse einen hohen mechanischen Schutz vor schädlichen Einflüssen.

Quality and functionality are crucial for the H-A housing series. The impressive features of these rectangular connectors are their compact shape and a new generation of locking levers. Furthermore, the housings provide high mechanical protection against damaging influences.

La qualité et la fonctionnalité donnent la mesure à la série de boîtiers H-A. Ces connecteurs multiples carrés persuadent par leur forme de boîtier compacte et par une génération d'étrier innovatrice. De plus, ces boîtiers offrent une très grande protection mécanique contre les influences nocives.



3.1 EPIC® D A - V I N C I H - A

Gehäuse / Housing / Boîtiers

Technische Daten:

Vorschriften: DIN 43652

Temperaturbereich: -40°C - +125°C

Schutzart: IP 65 (H-A 10 / 16 / 32 / 48)

IP-Schutzart für H-A 3 Metallgehäuse ist abhängig vom verwendeten Einsatz

Werkstoff:

H-A 3: Zinkdruckguß, pulverbeschichtet / Thermoplast, Brandverhalten nach UL 94 V-0

H-A 10 – 48: Aluminiumlegierung, pulverbeschichtet

Technical Data:

Specifications: DIN 43652

Temperature range: -40°C - +125°C

Protection class: IP 65 (H-A 10 / 16 / 32 / 48)

IP for H-A 3 metal housing depends on the insert type

Material:

H-A 3: Die cast zinc, powder coated / Thermoplast, flame retardent material rated UL 94 V-0

H-A 10 – 48: aluminium alloy, powder coated

Caractéristiques techniques:

Règlements: DIN 43652

Gamme de température: -40°C - +125°C

Degré de protection: IP 65 (H-A 3 10 / 16 / 32 / 48)

IP pour H-A 3 boîtier dépendent d'insert

Matière:

H-A 3: Zinc moulé par injection, recouvert par pulvérisation / plastique thermoformé, résistance au feu suivant UL 94 V-0

H-A 10 – 48: Alliage aluminium, recouvert par pulvérisation



H-A 3: Zinkdruckguß, pulverbeschichtet (grau) / Thermoplast, Brandverhalten nach UL 94 V-0
H-A 3: Die cast zinc, powder coated (grey) / Thermoplast, flame retardent material rated UL 94 V-0
H-A 3: Zinc moulé par injection, recouvert par pulvérisation (grise) / plastique thermoformé, résistance au feu suivant UL 94 V-0

Für den industriellen Einsatz in anspruchsvoller Umgebung
For industrial applications in demanding environments.
Pour une exploitation industrielle dans un environnement exigeant.



H-A 10 – 48: Aluminiumlegierung, pulverbeschichtet (grau), Bügel und Bolzen aus verzinktem Stahl
H-A 10 – 48: aluminium alloy, powder coated (grey), locking levers and bolts made of zinc plated steel
H-A 10 – 48: Alliage aluminium, recouvert par pulvérisation (grise), leviers et ergots acier recouvert par zinc

Für den industriellen Einsatz in anspruchsvoller Umgebung
For industrial applications in demanding environments.
Pour une exploitation industrielle dans un environnement exigeant.



EP: (Environmental Protected)
H-A 10 – 48: Aluminiumlegierung, pulverbeschichtet (schwarz), Bügel und Bolzen aus Edelstahl
H-A 10 – 48: aluminium alloy, powder coated (black), locking levers and bolts made of stainless steel
H-A 10 – 48: Alliage aluminium, recouvert par pulvérisation (noir), leviers et ergots acier inox

Für den industriellen Einsatz in stark beanspruchter Umgebung mit aggressiver Atmosphäre
For industrial applications in extremely demanding environments with aggressive atmospheres
Pour l'exploitation industrielle dans un environnement très sollicité à atmosphère agressive

3.1 EPIC® D A - V I N C I H - A

Tüllengehäuse / Hood / Capot

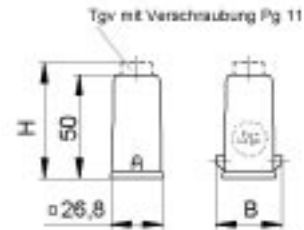

EPIC® H-A Gehäuse: Tüllengehäuse (Kabeleingang gerade)

EPIC® H-A housings: hood (top entry)

Boîtiers EPIC® H-A: capot (sortie verticale)

H-A 3

Artikel <i>part article</i>	Art.Nr. <i>part No. N° art.</i>	PG	Material <i>material matière</i>	Farbe <i>colour couleur</i>	Verschraubung <i>cable gland presse-étoupe</i>	B	H
H-A 3 MTgv	10512100*	11	Zinkdruckguß / <i>zinc die cast / zinc moulé par injection</i>	grau/grey/grise		33,5	
H-A 3 Tgv	10425500*	11	Thermoplast / <i>thermoplastic / plastique thermoformé</i>	schwarz/black/noir		36	
H-A 3 Tgv	10426000*	11	Thermoplast / <i>thermoplastic / plastique thermoformé</i>	grau/grey/grise		36	
H-A 3 MTgv	10426500*	11	Zinkdruckguß / <i>zinc die cast / zinc moulé par injection</i>	grau/grey/grise	●	33,5	57
H-A 3 Tgv	10426700*	11	Thermoplast / <i>thermoplastic / plastique thermoformé</i>	schwarz/black/noir	●	36	62
H-A 3 Tgv	10426400*	11	Thermoplast / <i>thermoplastic / plastique thermoformé</i>	grau/grey/grise	●	36	62

Einsätze / *Inserts / Inserts*: 1.1: H-A 3, H-A 4 / 1.2: STA 6 / 1.6: H-D 7, H-D 8

Kabelverschraubung / *Cable gland / Presse-étoupe*: 4.1

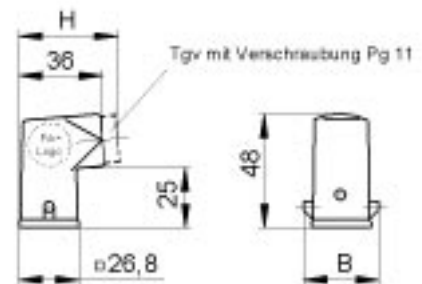

EPIC® H-A Gehäuse: Tüllengehäuse (Kabeleingang seitlich)

EPIC® H-A housings: hood (side entry)

Boîtiers EPIC® H-A: capot (sortie latérale)

H-A 3

Artikel <i>part article</i>	Art.Nr. <i>part No. N° art.</i>	PG	Material <i>material matière</i>	Farbe <i>colour couleur</i>	Verschraubung <i>cable gland presse-étoupe</i>	B	H
H-A 3 MTs	10512300	11	Zinkdruckguß / <i>zinc die cast / zinc moulé par injection</i>	grau/grey/grise		33,5	
H-A 3 Ts	10427300	11	Thermoplast / <i>thermoplastic / plastique thermoformé</i>	schwarz/black/noir		36	
H-A 3 Ts	10427000*	11	Thermoplast / <i>thermoplastic / plastique thermoformé</i>	grau/grey/grise		36	
H-A 3 MTs	10427500*	11	Zinkdruckguß / <i>zinc die cast / zinc moulé par injection</i>	grau/grey/grise	●	33,5	43
H-A 3 Ts	10620600	11	Thermoplast / <i>thermoplastic / plastique thermoformé</i>	schwarz/black/noir	●	36	48
H-A 3 Ts	10427100	11	Thermoplast / <i>thermoplastic / plastique thermoformé</i>	grau/grey/grise	●	36	48

Einsätze / *Inserts / Inserts*: 1.1: H-A 3, H-A 4 / 1.2: STA 6 / 1.6: H-D 7, H-D 8

Kabelverschraubung / *Cable gland / Presse-étoupe*: 4.1

3.1 EPIC® D A - V I N C I H - A

Tüllengehäuse / Hood / Capot

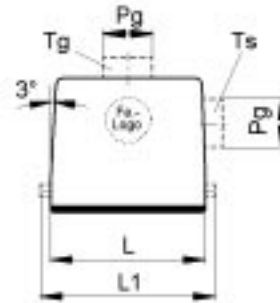

EPIC® H-A Gehäuse: Tüllengehäuse (Kabeleingang gerade, Bolzen für Längsbügel)

EPIC® H-A housings: hood (top entry, bolts for single locking lever)

Boîtiers EPIC® H-A: capot (sortie verticale, ergots pour simple levier)

H-A 10

Artikel part article	Art.Nr. part No. N° art.	Art.Nr.: EP part No.: EP N° art.: EP	PG	L	L1	L2	L3	L4	B	B1	B2	B3	B4	B5	H	H1	H2	S	d
H-A 10 TG 13,5	10446000*		13,5																
H-A 10 TG 16	10446100*	70461000	16	63	73				29,5						53,3				

Einsätze / Inserts / Inserts: 1.1: H-A 10 / 1.2: STA 14 / 1.6: H-D 15

Deckel / Cover / Couvercle: 5.1: H-A 10

Kabelverschraubung / Cable gland / Presse-étoupe: 4.1

H-A 16

Artikel part article	Art.Nr. part No. N° art.	Art.Nr.: EP part No.: EP N° art.: EP	PG	L	L1	L2	L3	L4	B	B1	B2	B3	B4	B5	H	H1	H2	S	d
H-A 16 TG 16	10565000*	70491000	16																
H-A 16 TG 21	10565300*		21	79	89				29,5						58,3				

Einsätze / Inserts / Inserts: 1.1: H-A 16 / 1.2: STA 20 / 1.6: H-D 25

Deckel / Cover / Couvercle: 5.1: H-A 16

Kabelverschraubung / Cable gland / Presse-étoupe: 4.1

EPIC® H-A Gehäuse: Tüllengehäuse (Kabeleingang gerade, Bolzen für Längsbügel, hohe Bauform)

EPIC® H-A housings: hood (top entry, bolts for single locking lever, high version)

Boîtiers EPIC® H-A: capot (sortie verticale, ergots pour simple levier, version haute)

H-A 10

Artikel part article	Art.Nr. part No. N° art.	Art.Nr.: EP part No.: EP N° art.: EP	PG	L	L1	L2	L3	L4	B	B1	B2	B3	B4	B5	H	H1	H2	S	d
H-A 10 TGH 16	70460200	70461200	16																
H-A 10 TGH 21	70460400	70461400	21	63	73				29,5						67,3				

Einsätze / Inserts / Inserts: 1.1: H-A 10 / 1.2: STA 14 / 1.6: H-D 15

Deckel / Cover / Couvercle: 5.1: H-A 10

Kabelverschraubung / Cable gland / Presse-étoupe: 4.1

H-A 16

Artikel part article	Art.Nr. part No. N° art.	Art.Nr.: EP part No.: EP N° art.: EP	PG	L	L1	L2	L3	L4	B	B1	B2	B3	B4	B5	H	H1	H2	S	d
H-A 16 TGH 16	70490200	70491200	16																
H-A 16 TGH 21	70490400	70491400	21	79	89				29,5						72,3				

Einsätze / Inserts / Inserts: 1.1: H-A 16 / 1.2: STA 20 / 1.6: H-D 25

Deckel / Cover / Couvercle: 5.1: H-A 16

Kabelverschraubung / Cable gland / Presse-étoupe: 4.1

3.1 EPIC® D A - V I N C I H - A

Tüllengehäuse / Hood / Capot

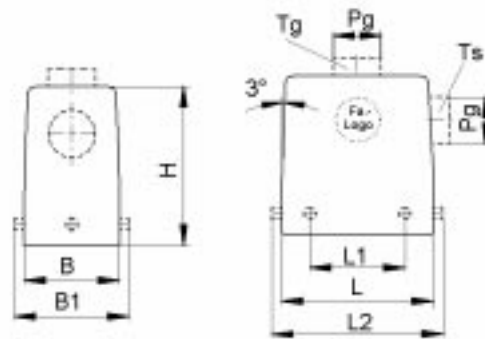

EPIC® H-A Gehäuse: Tüllengehäuse (Kabeleingang gerade, Bolzen für Querbügel)

EPIC® H-A housings: hood (top entry, bolts for double locking lever)

Boîtiers EPIC® H-A: capot (sortie verticale, ergots pour double levier)

H-A 32

Artikel part article	Art.Nr. part No. N° art.	Art.Nr.: EP part No.: EP N° art.: EP	PG	L	L1	L2	L3	L4	B	B1	B2	B3	B4	B5	H	H1	H2	S	d
H-A 32 TG 21	10582000*	70521200	21												75				
H-A 32 TG 29	10583000*	70521400	29	82	49,6				56	70,8									

Einsätze / Inserts / Inserts: 1.1: H-A 32 / 1.2: 2 x STA 20 / 1.6: H-D 50

Deckel / Cover / Couvercle: 5.1: H-A 32

Kabelverschraubung / Cable gland / Presse-étoupe: 4.1

H-A 48

Artikel part article	Art.Nr. part No. N° art.	Art.Nr.: EP part No.: EP N° art.: EP	PG	L	L1	L2	L3	L4	B	B1	B2	B3	B4	B5	H	H1	H2	S	d
H-A 48 TG 29	10631800	-	29	93,5	64,5				79	89,5					95				

Einsätze / Inserts / Inserts: 1.1: H-A 48

Kabelverschraubung / Cable gland / Presse-étoupe: 4.1

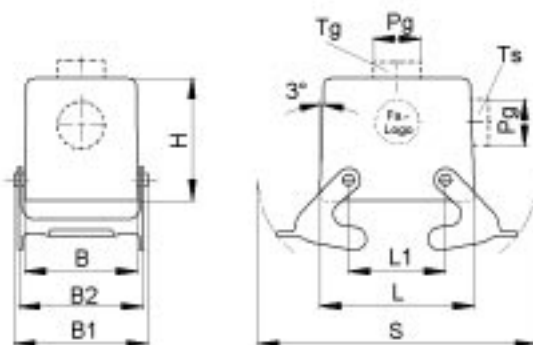

EPIC® H-A Gehäuse: Tüllengehäuse (Kabeleingang gerade, Querbügel)

EPIC® H-A housings: hood (top entry, double locking lever)

Boîtiers EPIC® H-A: capot (sortie verticale, double levier)

H-A 32

Artikel part article	Art.Nr. part No. N° art.	Art.Nr.: EP part No.: EP N° art.: EP	PG	L	L1	L2	L3	L4	B	B1	B2	B3	B4	B5	H	H1	H2	S	d
H-A 32 TGB 21	10584000	70526200	21												75				
H-A 32 TGB 29	10585000	70526400	29	82	49,6				56	70,8	66							124,5	

Einsätze / Inserts / Inserts: 1.1: H-A 32 / 1.2: 2 x STA 20 / 1.6: H-D 50

Deckel / Cover / Couvercle: 5.1: H-A 32

Kabelverschraubung / Cable gland / Presse-étoupe: 4.1

3.1 EPIC® D A - V I N C I H - A

Tüllengehäuse / Hood / Capot

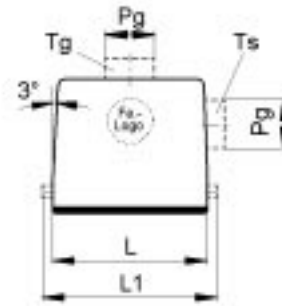

EPIC® H-A Gehäuse: Tüllengehäuse (Kabeleingang seitlich, Bolzen für Längsbügel)

EPIC® H-A housings: hood (side entry, bolts for single locking lever)

Boîtiers EPIC® H-A: capot (sortie latérale, ergots pour simple levier)

H-A 10

Artikel part article	Art.Nr. part No. N° art.	Art.Nr.: EP part No.: EP N° art.: EP	PG	L	L1	L2	L3	L4	B	B1	B2	B3	B4	B5	H	H1	H2	S	d
H-A 10 TS 16	10445000*	70463000	16		63	73			29,5						53,3				
H-A 10 TS 21	10445500*		21																

Einsätze / Inserts / Inserts: 1.1: H-A 10 / 1.2: STA 14 / 1.6: H-D 15

Deckel / Cover / Couvercle: 5.1: H-A 10

Kabelverschraubung / Cable gland / Presse-étoupe: 4.1

H-A 16

Artikel part article	Art.Nr. part No. N° art.	Art.Nr.: EP part No.: EP N° art.: EP	PG	L	L1	L2	L3	L4	B	B1	B2	B3	B4	B5	H	H1	H2	S	d
H-A 16 TS 16	10564000*	70493000	16	79	89				29,5						58,3				
H-A 16 TS 21	10564500*		21																

Einsätze / Inserts / Inserts: 1.1: H-A 16 / 1.2: STA 20 / 1.6: H-D 25

Deckel / Cover / Couvercle: 5.1: H-A 16

Kabelverschraubung / Cable gland / Presse-étoupe: 4.1

EPIC® H-A Gehäuse: Tüllengehäuse (Kabeleingang seitlich, Bolzen für Längsbügel, hohe Bauform)

EPIC® H-A housings: hood (side entry, bolts for single locking lever, high version)

Boîtiers EPIC® H-A: capot (sortie latérale, ergots pour simple levier, version haute)

H-A 10

Artikel part article	Art.Nr. part No. N° art.	Art.Nr.: EP part No.: EP N° art.: EP	PG	L	L1	L2	L3	L4	B	B1	B2	B3	B4	B5	H	H1	H2	S	d
H-A 10 TSH 16	70462200	70463200	16		63	73			29,5						67,3				
H-A 10 TSH 21	70462400	70463400	21																

Einsätze / Inserts / Inserts: 1.1: H-A 10 / 1.2: STA 14 / 1.6: H-D 15

Deckel / Cover / Couvercle: 5.1: H-A 10

Kabelverschraubung / Cable gland / Presse-étoupe: 4.1

H-A 16

Artikel part article	Art.Nr. part No. N° art.	Art.Nr.: EP part No.: EP N° art.: EP	PG	L	L1	L2	L3	L4	B	B1	B2	B3	B4	B5	H	H1	H2	S	d
H-A 16 TSH 16	70492200	70493200	16	79	89				29,5						72,3				
H-A 16 TSH 21	70492400	70493400	21																

Einsätze / Inserts / Inserts: 1.1: H-A 16 / 1.2: STA 20 / 1.6: H-D 25

Deckel / Cover / Couvercle: 5.1: H-A 16

Kabelverschraubung / Cable gland / Presse-étoupe: 4.1

3.1 EPIC® D A - V I N C I H - A

Tüllengehäuse / Hood / Capot

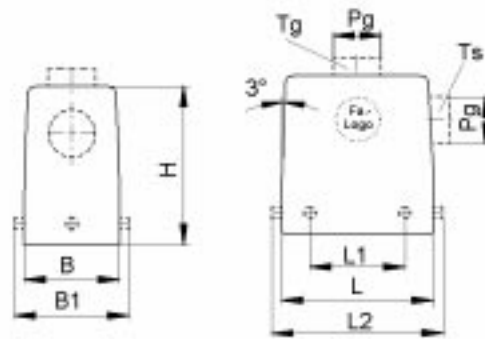

EPIC® H-A Gehäuse: Tüllengehäuse (Kabeleingang seitlich, Bolzen für Querbügel)

EPIC® H-A housings: hood (side entry, bolts for double locking lever)

Boîtiers EPIC® H-A: capot (sortie latérale, ergots pour double levier)

H-A 32

Artikel part article	Art.Nr. part No. N° art.	Art.Nr.: EP part No.: EP N° art.: EP	PG	L	L1	L2	L3	L4	B	B1	B2	B3	B4	B5	H	H1	H2	S	d
H-A 32 TS 21	10576000*	70523200	21												75				
H-A 32 TS 29	10577000*	70523400	29	82	49,6				56	70,8									

Einsätze / Inserts / Inserts: 1.1: H-A 32 / 1.2: 2 x STA 20 / 1.6: H-D 50

Deckel / Cover / Couvercle: 5.1: H-A 32

Kabelverschraubung / Cable gland / Presse-étoupe: 4.1

H-A 48

Artikel part article	Art.Nr. part No. N° art.	Art.Nr.: EP part No.: EP N° art.: EP	PG	L	L1	L2	L3	L4	B	B1	B2	B3	B4	B5	H	H1	H2	S	d
H-A 48 TS 29	10630800*	-	29	93,5	64,5				79	89,5					95				

Einsätze / Inserts / Inserts: 1.1: H-A 48

Kabelverschraubung / Cable gland / Presse-étoupe: 4.1

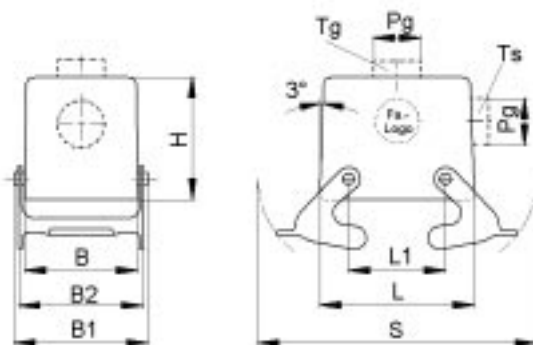

EPIC® H-A Gehäuse: Tüllengehäuse (Kabeleingang seitlich, Querbügel)

EPIC® H-A housings: hood (side entry, double locking lever)

Boîtiers EPIC® H-A: capot (sortie latérale, double levier)

H-A 32

Artikel part article	Art.Nr. part No. N° art.	Art.Nr.: EP part No.: EP N° art.: EP	PG	L	L1	L2	L3	L4	B	B1	B2	B3	B4	B5	H	H1	H2	S	d
H-A 32 TSB 21	10578000*	70528200	21	82	49,6				56	70,8	66			75				124,5	
H-A 32 TSB 29	10579000	70528400	29																

Einsätze / Inserts / Inserts: 1.1: H-A 32 / 1.2: 2 x STA 20 / 1.6: H-D 50

Deckel / Cover / Couvercle: 5.1: H-A 32

Kabelverschraubung / Cable gland / Presse-étoupe: 4.1

3.1 EPIC® D A - V I N C I H - A

Anbaugehäuse / Panel mount base / Embase encastrée

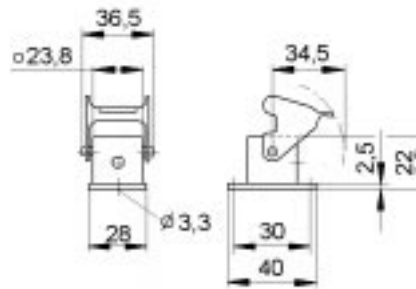

EPIC® H-A Gehäuse: Anbaugehäuse
EPIC® H-A housings: panel mount base
Boîtiers EPIC® H-A: embase encastrée

H-A 3

Artikel <i>part article</i>	Art.Nr. <i>part No. N° art.</i>	PG	Material <i>material matière</i>	Farbe <i>colour couleur</i>	Verschraubung <i>cable gland presse-étoupe</i>	B	H
H-A 3 MAg	10422500*		Zinkdruckguß / <i>zinc die cast / zinc moulé par injection</i>	grau/grey/grise			
H-A 3 Ag	10422200*		Thermoplast / <i>thermoplastic / plastique thermoformé</i>	schwarz/black/noir			
H-A 3 Ag	10422000*		Thermoplast / <i>thermoplastic / plastique thermoformé</i>	grau/grey/grise			

Einsätze / *Inserts / Inserts*: 1.1: H-A 3, H-A 4 / 1.2: STA 6 / 1.6: H-D 7, H-D 8
 Deckel / *Cover / Couvercle*: 5.1: H-A 3

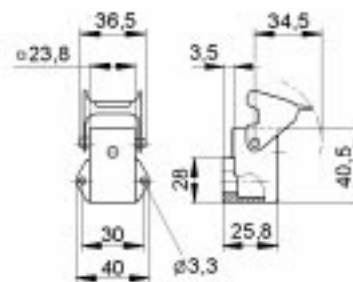

EPIC® H-A Gehäuse: Anbaugehäuse (gewinkelt)
EPIC® H-A housings: panel mount base (angled)
Boîtiers EPIC® H-A: embase encastrée (sortie latérale)

H-A 3

Artikel <i>part article</i>	Art.Nr. <i>part No. N° art.</i>	PG	Material <i>material matière</i>	Farbe <i>colour couleur</i>	Verschraubung <i>cable gland presse-étoupe</i>	B	H
H-A 3 MAgs	10423500*		Zinkdruckguß / <i>zinc die cast / zinc moulé par injection</i>	grau/grey/grise			
H-A 3 Ags	10423100*		Thermoplast / <i>thermoplastic / plastique thermoformé</i>	schwarz/black/noir			
H-A 3 Ags	10423000*		Thermoplast / <i>thermoplastic / plastique thermoformé</i>	grau/grey/grise			

Einsätze / *Inserts / Inserts*: 1.1: H-A 3, H-A 4 / 1.2: STA 6 / 1.6: H-D 7, H-D 8
 Deckel / *Cover / Couvercle*: 5.1: H-A 3

3.1 EPIC® D A - V I N C I H - A

Anbaugehäuse / Panel mount base / Embase encastrée

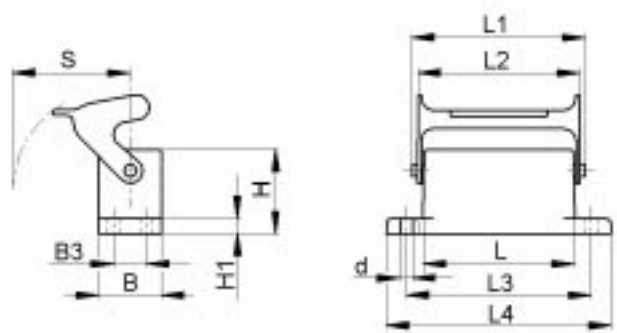

EPIC® H-A Gehäuse: Anbaugehäuse (Längsbügel)
EPIC® H-A housings: panel mount base (single locking lever)
Boîtiers EPIC® H-A: embase encastrée (simple levier)

H-A 10

Artikel part article	Art.Nr. part No. N° art.	Art.Nr.: EP part No: EP N° art.: EP	PG	L	L1	L2	L3	L4	B	B1	B2	B3	B4	B5	H	H1	H2	S	d
H-A 10 AG-LB	10442000*	70442500		63	74,4	71,4	70	81	29,5						25	3,5		36,5	3,6

Einsätze / Inserts / Inserts: 1.1: H-A 10 / 1.2: STA 14 / 1.6: H-D 15
 Deckel / Cover / Couvercle: 5.1: H-A 10

H-A 16

Artikel part article	Art.Nr. part No. N° art.	Art.Nr.: EP part No: EP N° art.: EP	PG	L	L1	L2	L3	L4	B	B1	B2	B3	B4	B5	H	H1	H2	S	d
H-A 16 AG-LB	10462000*	70472500		79	90,4	87,8	86	96	29,5						25	3,5		36,5	3,6

Einsätze / Inserts / Inserts: 1.1: H-A 16 / 1.2: STA 20 / 1.6: H-D 25
 Deckel / Cover / Couvercle: 5.1: H-A 16

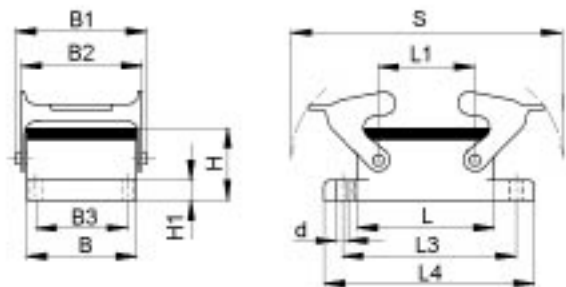

EPIC® H-A Gehäuse: Anbaugehäuse (Querbügel)
EPIC® H-A housings: panel mount base (double locking lever)
Boîtiers EPIC® H-A: embase encastrée (double levier)

H-A 32

Artikel part article	Art.Nr. part No. N° art.	Art.Nr.: EP part No: EP N° art.: EP	PG	L	L1	L2	L3	L4	B	B1	B2	B3	B4	B5	H	H1	H2	S	d
H-A 32 AG	10472000*	70502500		82	49,6		92	102	56	70,8	66	42			25,4	4		124,5	4,3

Einsätze / Inserts / Inserts: 1.1: H-A 32 / 1.2: 2 x STA 20 / 1.6: H-D 50
 Deckel / Cover / Couvercle: 5.1: H-A 32

H-A 48

Artikel part article	Art.Nr. part No. N° art.	Art.Nr.: EP part No: EP N° art.: EP	PG	L	L1	L2	L3	L4	B	B1	B2	B3	B4	B5	H	H1	H2	S	d
H-A 48 AG	10625500*	-		93,5	64,5		110	124	79	93,8	87,8	65			30,3	5		136,5	5,5

Einsätze / Inserts / Inserts: 1.1: H-A 48

3.1 EPIC® D A - V I N C I H - A

Anbaugehäuse / Panel mount base / Embase encastrée

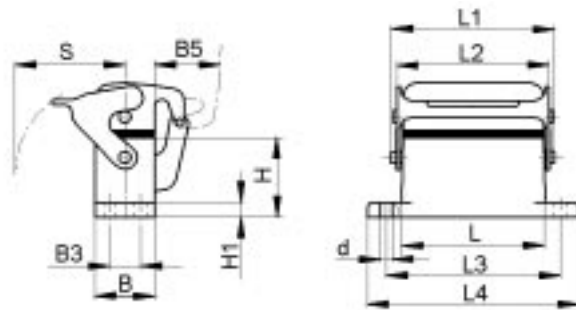

EPIC® H-A Gehäuse: Anbaugehäuse (Schutzdeckel, Längsbügel)

EPIC® H-A housings: panel mount base (cover, single locking lever)

Boîtiers EPIC® H-A: embase encastrée (couverture, simple levier)

H-A 10

Artikel part article	Art.Nr. part No. N° art.	Art.Nr.: EP part No: EP N° art.: EP	PG	L	L1	L2	L3	L4	B	B1	B2	B3	B4	B5	H	H1	H2	S	d
H-A 10 AD-LB	70444000	70444500		63	74,4	71,4	70	81	29,5			17,5		25	25	3,5		36,5	3,6

Einsätze / Inserts / Inserts: 1.1: H-A 10 / 1.2: STA 14 / 1.6: H-D 15

H-A 16

Artikel part article	Art.Nr. part No. N° art.	Art.Nr.: EP part No: EP N° art.: EP	PG	L	L1	L2	L3	L4	B	B1	B2	B3	B4	B5	H	H1	H2	S	d
H-A 16 AD-LB	70474000	70474500		79	90,4	87,5	86	96	29,5			17,5		25	25	3,5		36,5	3,6

Einsätze / Inserts / Inserts: 1.1:H-A 16 / 1.2: STA 20 / 1.6: H-D 25

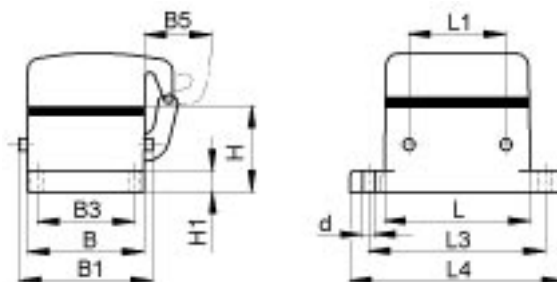

EPIC® H-A Gehäuse: Anbaugehäuse (Schutzdeckel, Bolzen für Querbügel)

EPIC® H-A housings: panel mount base (cover, bolts for double locking lever)

Boîtiers EPIC® H-A: embase encastrée (couverture, ergots pour double levier)

H-A 32

Artikel part article	Art.Nr. part No. N° art.	Art.Nr.: EP part No: EP N° art.: EP	PG	L	L1	L2	L3	L4	B	B1	B2	B3	B4	B5	H	H1	H2	S	d
H-A 32 AD-BO	70503000	70503500		82	49,6		92	102	56			42		29	25,4	4		4,3	

Einsätze / Inserts / Inserts: 1.1: H-A 32 / 1.2: 2 x STA 20 / 1.6: H-D 50

3.1 EPIC® D A - V I N C I H - A

Sockelgehäuse / *Surface mount base* / *Embase en saillie*

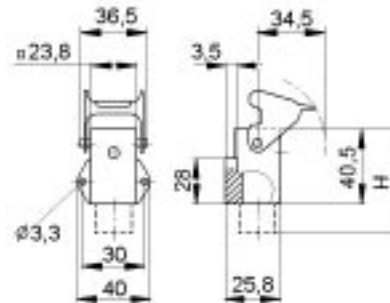
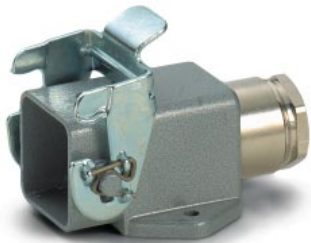

EPIC® H-A Gehäuse: Sockelgehäuse
EPIC® H-A housings: surface mount base
Boîtiers EPIC® H-A: embase en saillie

H-A 3

Artikel <i>part</i> <i>article</i>	Art.Nr. <i>part No.</i> <i>N° art.</i>	PG	Material <i>material</i> <i>matière</i>	Farbe <i>colour</i> <i>couleur</i>	Verschraubung <i>cable gland</i> <i>presse-étoupe</i>	B	H
H-A 3 MAgsv	10512700	11	Zinkdruckguß / <i>zinc die cast</i> / <i>zinc moulé par injection</i>	grau/grey/grise			51,5
H-A 3 Agsv	10511700	11	Thermoplast / <i>thermoplastic</i> / <i>plastique thermoformé</i>	schwarz/black/noir			56
H-A 3 Agsv	10424000*	11	Thermoplast / <i>thermoplastic</i> / <i>plastique thermoformé</i>	grau/grey/grise			56
H-A 3 MAgsv	10424500*	11	Zinkdruckguß / <i>zinc die cast</i> / <i>zinc moulé par injection</i>	grau/grey/grise	●		57,5
H-A 3 Agsv	10424700	11	Thermoplast / <i>thermoplastic</i> / <i>plastique thermoformé</i>	schwarz/black/noir	●		65
H-A 3 Agsv	10424200	11	Thermoplast / <i>thermoplastic</i> / <i>plastique thermoformé</i>	grau/grey/grise	●		65

Einsätze / *Inserts* / *Inserts*: 1.1: H-A 3, H-A 4 / 1.2: STA 6 / 1.6: H-D 7, H-D 8

Deckel / *Cover* / *Couvercle*: 5.1: H-A 3

Kabelverschraubung / *Cable gland* / *Presse-étoupe*: 4.1

3.1 EPIC® D A - V I N C I H - A

Sockelgehäuse / Surface mount base / Embase en saillie

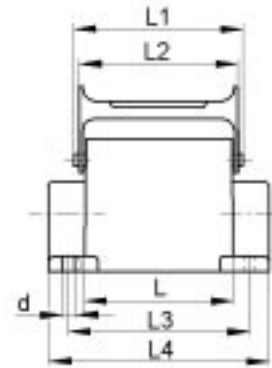
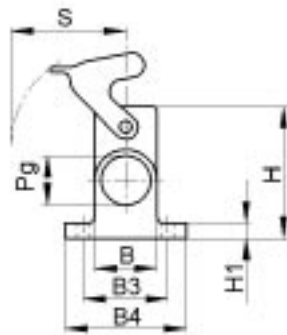

EPIC® H-A Gehäuse: Sockelgehäuse (1 Kabeleingang, Längsbügel)
EPIC® H-A housings: surface mount base (1 cable entry, single locking lever)
Boîtiers EPIC® H-A: embase en saillie (1 entrée de câble, simple levier)

H-A 10

Artikel part article	Art.Nr. part No. N° art.	Art.Nr.: EP part No.: EP N° art.: EP	PG	L	L1	L2	L3	L4	B	B1	B2	B3	B4	B5	H	H1	H2	S	d
H-A 10 SGR-LB 16	10448100*	70447200	16	63	74,4	71,4	48	80	29,5			40	50		57	3,5		36,5	4,5
H-A 10 SGR-LB 21	10448000*	70447400	21																

Einsätze / Inserts / Inserts: 1.1: H-A 10 / 1.2: STA 14 / 1.6: H-D 15

Deckel / Cover / Couvercle: 5.1: H-A 10

Kabelverschraubung / Cable gland / Presse-étoupe: 4.1

H-A 16

Artikel part article	Art.Nr. part No. N° art.	Art.Nr.: EP part No.: EP N° art.: EP	PG	L	L1	L2	L3	L4	B	B1	B2	B3	B4	B5	H	H1	H2	S	d
H-A 16 SGR-LB 16	10567100*	70477200	16	79	90,4	87,8	64	96	29,5			40	50		57	3,5		36,5	4,5
H-A 16 SGR-LB 21	10567000*	70477400	21																

Einsätze / Inserts / Inserts: 1.1: H-A 16 / 1.2: STA 20 / 1.6: H-D 25

Deckel / Cover / Couvercle: 5.1: H-A 16

Kabelverschraubung / Cable gland / Presse-étoupe: 4.1

EPIC® H-A Gehäuse: Sockelgehäuse (2 Kabeleingänge, Längsbügel)
EPIC® H-A housings: surface mount base (2 cable entries, single locking lever)
Boîtiers EPIC® H-A: embase à encastrer (2 entrées de câble, simple levier)

H-A 10

Artikel part article	Art.Nr. part No. N° art.	Art.Nr.: EP part No.: EP N° art.: EP	PG	L	L1	L2	L3	L4	B	B1	B2	B3	B4	B5	H	H1	H2	S	d
H-A 10 SGRL-LB 16	10450100*	70448200	16	63	74,4	71,4	48	80	29,5			40	50		57	3,5		36,5	4,5
H-A 10 SGRL-LB 21	10450000*	70448400	21																

Einsätze / Inserts / Inserts: 1.1: H-A 10 / 1.2: STA 14 / 1.6: H-D 15

Deckel / Cover / Couvercle: 5.1: H-A 10

Kabelverschraubung / Cable gland / Presse-étoupe: 4.1

H-A 16

Artikel part article	Art.Nr. part No. N° art.	Art.Nr.: EP part No.: EP N° art.: EP	PG	L	L1	L2	L3	L4	B	B1	B2	B3	B4	B5	H	H1	H2	S	d
H-A 16 SGRL-LB 16	10568100*	70478200	16	79	90,4	87,8	64	96	29,5			40	50		57	3,5		36,5	4,5
H-A 16 SGRL-LB 21	10568000	70478400	21																

Einsätze / Inserts / Inserts: 1.1: H-A 16 / 1.2: STA 20 / 1.6: H-D 25

Deckel / Cover / Couvercle: 5.1: H-A 16

Kabelverschraubung / Cable gland / Presse-étoupe: 4.1

3.1 EPIC® D A - V I N C I H - A

Sockelgehäuse / *Surface mount base* / *Embase en saillie*

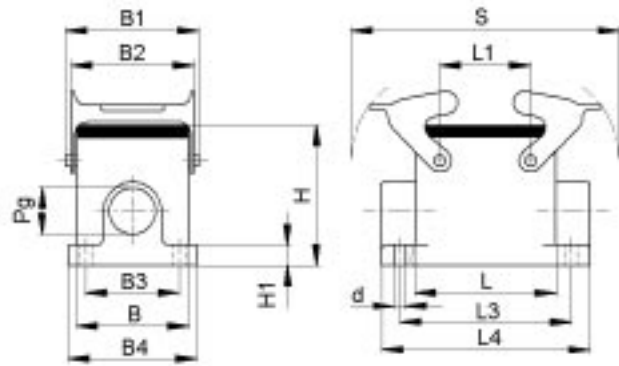

EPIC® H-A Gehäuse: Sockelgehäuse (1 Kabeleingang, Querbügel)

EPIC® H-A housings: surface mount base (1 cable entry, double locking lever)

Boîtiers EPIC® H-A: embase en saillie (1 entrée de câble, double levier)

H-A 32

Artikel part article	Art.Nr. part No. N° art.	Art.Nr.: EP part No: EP N° art.: EP	PG	L	L1	L2	L3	L4	B	B1	B2	B3	B4	B5	H	H1	H2	S	d
H-A 32 SGR 21	10474000*	70507200	21																
H-A 32 SGR 29	10474100*	70507400	29	82	49,6		94	106	56	70,8	66	46	57		75	4		124,5	5,5

Einsätze / *Inserts* / *Inserts*: 1.1: H-A 32 / 1.2: 2 x STA 20 / 1.6: H-D 50

Deckel / *Cover* / *Couvercle*: 5.1: H-A 32

Kabelverschraubung / *Cable gland* / *Presse-étoupe*: 4.1

H-A 48

Artikel part article	Art.Nr. part No. N° art.	Art.Nr.: EP part No: EP N° art.: EP	PG	L	L1	L2	L3	L4	B	B1	B2	B3	B4	B5	H	H1	H2	S	d
H-A 48 SGR 29	10633800	-	29	93,5	64,5		112	124,5	79	93,8	87,8	67	81		72	5		136,5	5,5

Einsätze / *Inserts* / *Inserts*: 1.1: H-A 48

Kabelverschraubung / *Cable gland* / *Presse-étoupe*: 4.1

3.1 EPIC® D A - V I N C I H - A

Sockelgehäuse / *Surface mount base* / *Embase en saillie*

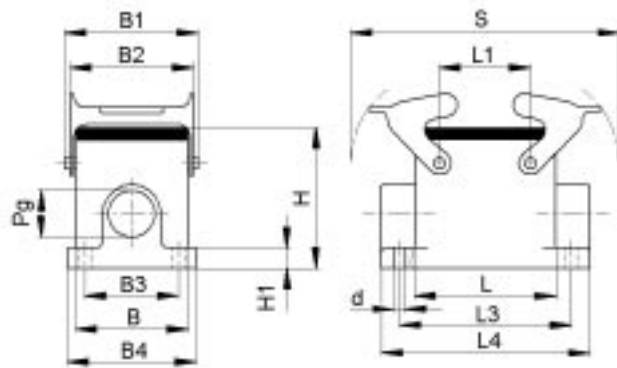

EPIC® H-A Gehäuse: Sockelgehäuse (2 Kabeleingänge, Querbügel)
EPIC® H-A housings: surface mount base (2 cable entries, double locking lever)
Boîtiers EPIC® H-A: embase en saillie (2 entrées de câble, double levier)

H-A 32

Artikel part article	Art.Nr. part No. N° art.	Art.Nr.: EP part No.: EP N° art.: EP	PG	L	L1	L2	L3	L4	B	B1	B2	B3	B4	B5	H	H1	H2	S	d	
H-A 32 SGRL21	10482000	70508200	21																	
H-A 32 SGRL 29	10482100	70508400	29	82	49,6		94	106	56	70,8	66	46	57		75	4		124,5	5,5	

Einsätze / *Inserts* / *Inserts*: 1.1: H-A 32 / 1.2: 2 x STA 20 / 1.6: H-D 50

Deckel / *Cover* / *Couvercle*: 5.1: H-A 32

Kabelverschraubung / *Cable gland* / *Presse-étoupe*: 4.1

H-A 48

Artikel part article	Art.Nr. part No. N° art.	Art.Nr.: EP part No.: EP N° art.: EP	PG	L	L1	L2	L3	L4	B	B1	B2	B3	B4	B5	H	H1	H2	S	d
H-A 48 SGRL 29	10634800	-	29	93,5	64,5		112	124,5	79	93,8	87,8	67	81		72	5		136,5	5,5

Einsätze / *Inserts* / *Inserts*: 1.1: H-A 48

Kabelverschraubung / *Cable gland* / *Presse-étoupe*: 4.1

3.1 EPIC® D A - V I N C I H - A

Sockelgehäuse / *Surface mount base* / *Embase en saillie*

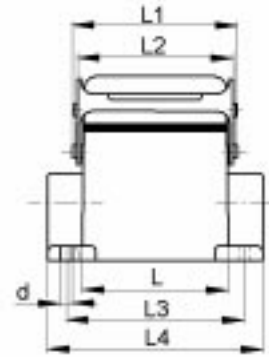
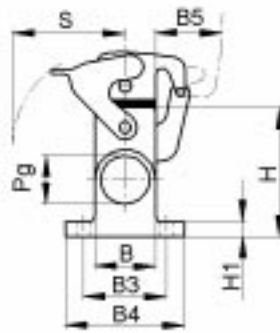

EPIC® H-A Gehäuse: Sockelgehäuse (Schutzdeckel, 1 Kabeleingang, Längsbügel)

EPIC® H-A housings: surface mount base (cover, 1 cable entry, single locking lever)

Boîtiers EPIC® H-A: embase en saillie (couvercle, 1 entrée de câble, simple levier)

H-A 10

Artikel part article	Art.Nr. part No. N° art.	Art.Nr.: EP part No.: EP N° art.: EP	PG	L	L1	L2	L3	L4	B	B1	B2	B3	B4	B5	H	H1	H2	S	d
H-A 10 SDR-LB 16	70455200	70457200	16	63	74,4	71,4	48	80	29,5			40	50	25	57	3,5		36,5	4,5
H-A 10 SDR-LB 21	70455400	70457400	21																

Einsätze / *Inserts* / *Inserts*: 1.1: H-A 10 / 1.2: STA 14 / 1.6: H-D 15

Kabelverschraubung / *Cable gland* / *Presse-étoupe*: 4.1

H-A 16

Artikel part article	Art.Nr. part No. N° art.	Art.Nr.: EP part No.: EP N° art.: EP	PG	L	L1	L2	L3	L4	B	B1	B2	B3	B4	B5	H	H1	H2	S	d
H-A 16 SDR-LB 16	70485200	70487200	16	79	90,4	87,8	64	96	29,5			40	50	25	57	3,5		36,5	4,5
H-A 16 SDR-LB 21	70485400	70487400	21																

Einsätze / *Inserts* / *Inserts*: 1.1: H-A 16 / 1.2: STA 20 / 1.6: H-D 25

Kabelverschraubung / *Cable gland* / *Presse-étoupe*: 4.1

EPIC® H-A Gehäuse: Sockelgehäuse (Schutzdeckel, 2 Kabeleingänge, Längsbügel)

EPIC® H-A housings: surface mount base (cover, 2 cable entries, single locking lever)

Boîtiers EPIC® H-A: embase en saillie (couvercle, 2 entrées de câble, simple levier)

H-A 10

Artikel part article	Art.Nr. part No. N° art.	Art.Nr.: EP part No.: EP N° art.: EP	PG	L	L1	L2	L3	L4	B	B1	B2	B3	B4	B5	H	H1	H2	S	d
H-A 10 SDRL-LB 16	70456200	70458200	16	63	74,4	71,4	48	80	29,5			40	50	25	57	3,5		36,5	4,5
H-A 10 SDRL-LB 21	70456400	70458400	21																

Einsätze / *Inserts* / *Inserts*: 1.1: H-A 10 / 1.2: STA 14 / 1.6: H-D 15

Kabelverschraubung / *Cable gland* / *Presse-étoupe*: 4.1

H-A 16

Artikel part article	Art.Nr. part No. N° art.	Art.Nr.: EP part No.: EP N° art.: EP	PG	L	L1	L2	L3	L4	B	B1	B2	B3	B4	B5	H	H1	H2	S	d
H-A 16 SDRL-LB 16	70486200	70488200	16	79	90,4	87,8	64	96	29,5			40	50	25	57	3,5		36,5	4,5
H-A 16 SDRL-LB 21	70486400	70488400	21																

Einsätze / *Inserts* / *Inserts*: 1.1: H-A 16 / 1.2: STA 20 / 1.6: H-D 25

Kabelverschraubung / *Cable gland* / *Presse-étoupe*: 4.1

3.1 EPIC® D A - V I N C I H - A

Sockelgehäuse / Surface mount base / Embase en saillie

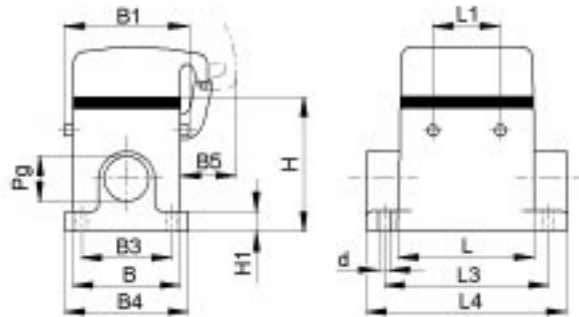

EPIC® H-A Gehäuse: Sockelgehäuse (Schutzdeckel, 1 Kabeleingang, Bolzen für Querbügel)

EPIC® H-A housings: surface mount base (cover, 1 cable entry, bolts for double locking lever)

Boîtiers EPIC® H-A: embase en saillie (couvercle, 1 entrée de câble, ergots pour double levier)

H-A 32

Artikel part article	Art.Nr. part No. N° art.	Art.Nr.: EP part No.: EP N° art.: EP	PG	L	L1	L2	L3	L4	B	B1	B2	B3	B4	B5	H	H1	H2	S	d
H-A 32 SDR-BO 21	70515200	70517200	21	82	49,6		94	106	56	70,8		46	57	29	75	4			5,5
H-A 32 SDR-BO 29	70515400	70517400	29																

Einsätze / Inserts / Inserts: 1.1: H-A 32 / 1.2: 2 x STA 20 / 1.6: H-D 50

Kabelverschraubung / Cable gland / Presse-étoupe: 4.1

EPIC® H-A Gehäuse: Sockelgehäuse (Schutzdeckel, 2 Kabeleingänge, Bolzen für Querbügel)

EPIC® H-A housings: surface mount base (cover, 2 cable entries, bolts for double locking lever)

Boîtiers EPIC® H-A: embase en saillie (couvercle, 2 entrées de câble, ergots pour double levier)

H-A 32

Artikel part article	Art.Nr. part No. N° art.	Art.Nr.: EP part No.: EP N° art.: EP	PG	L	L1	L2	L3	L4	B	B1	B2	B3	B4	B5	H	H1	H2	S	d
H-A 32 SDRL-BO 21	70516200	70518200	21	82	49,6		94	106	56	70,8		46	57	29	75	4			5,5
H-A 32 SDRL-BO 29	70516400	70518400	29																

Einsätze / Inserts / Inserts: 1.1: H-A 32 / 1.2: STA 20 / 1.6: H-D 50

Kabelverschraubung / Cable gland / Presse-étoupe: 4.1

3.1 EPIC® D A - V I N C I H - A

Kupplungsgehäuse / *Cable coupler hood* / *Capot prolongateur*

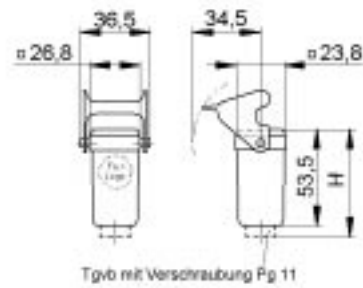

EPIC® H-A Gehäuse: Kupplungsgehäuse (Kabeleingang gerade)

EPIC® H-A housings: cable coupler hood (top entry)

Boîtiers EPIC® H-A: capot prolongateur (sortie verticale)

H-A 3

Artikel <i>part</i> <i>article</i>	Art.Nr. <i>part No.</i> <i>N° art.</i>	PG	Material <i>material</i> <i>matière</i>	Farbe <i>colour</i> <i>couleur</i>	Verschraubung <i>cable gland</i> <i>presse-étoupe</i>	B	H
H-A 3 MTgvb	10512900	11	Zinkdruckguß / <i>zinc die cast</i> / <i>zinc moulé par injection</i>	grau/grey/grise			
H-A 3 Tgvb	10429200	11	Thermoplast / <i>thermoplastic</i> / <i>plastique thermoformé</i>	schwarz/black/noir			
H-A 3 Tgvb	10429000*	11	Thermoplast / <i>thermoplastic</i> / <i>plastique thermoformé</i>	grau/grey/grise			
H-A 3 MTgvb	10429500*	11	Zinkdruckguß / <i>zinc die cast</i> / <i>zinc moulé par injection</i>	grau/grey/grise	●		60
H-A 3 Tgvb	10620300	11	Thermoplast / <i>thermoplastic</i> / <i>plastique thermoformé</i>	schwarz/black/noir	●		65
H-A 3 Tgvb	10429100	11	Thermoplast / <i>thermoplastic</i> / <i>plastique thermoformé</i>	grau/grey/grise	●		65

Einsätze / *Inserts* / *Inserts*: 1.1: H-A 3, H-A 4 / 1.2: STA 6 / 1.6: H-D 7, H-D 8

Deckel / *Cover* / *Couvercle*: 5.1: H-A 3

Kabelverschraubung / *Cable gland* / *Presse-étoupe*: 4.1

3.1 EPIC® D A - V I N C I H - A

Kupplungsgehäuse / Cable coupler hood / Capot prolongateur

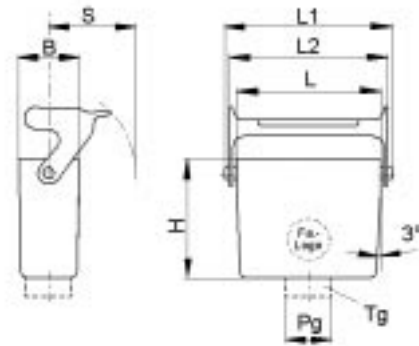

EPIC® H-A Gehäuse: Kupplungsgehäuse (Kabeleingang gerade, Längsbügel)

EPIC® H-A housings: cable coupler hood (top entry, single locking lever)

Boîtiers EPIC® H-A: capot prolongateur (sortie verticale, simple levier)

H-A 10

Artikel part article	Art.Nr. part No. N° art.	Art.Nr.: EP part No.: EP N° art.: EP	PG	L	L1	L2	L3	L4	B	B1	B2	B3	B4	B5	H	H1	H2	S	d
H-A 10 TBF-LB 13,5	10439000*		16	63	74,4	71,4			29,5						48				36,5
H-A 10 TBF-LB 16	70450000	70451000																	

Einsätze / Inserts / Inserts: 1.1: H-A 10 / 1.2: STA 14 / 1.6: H-D 15

Deckel / Cover / Couvercle: 5.1: H-A 10

Kabelverschraubung / Cable gland / Presse-étoupe: 4.1

H-A 16

Artikel part article	Art.Nr. part No. N° art.	Art.Nr.: EP part No.: EP N° art.: EP	PG	L	L1	L2	L3	L4	B	B1	B2	B3	B4	B5	H	H1	H2	S	d
H-A 16 TBF-LB 16	10563000	70481000	16	79	90,4	87,8			29,5						53				36,5

Einsätze / Inserts / Inserts: 1.1: H-A 16 / 1.2: STA 20 / 1.6: H-D 25

Deckel / Cover / Couvercle: 5.1: H-A 16

Kabelverschraubung / Cable gland / Presse-étoupe: 4.1

EPIC® H-A Gehäuse: Kupplungsgehäuse (Kabeleingang gerade, Längsbügel, hohe Bauform)

EPIC® H-A housings: cable coupler hood (top entry, single locking lever, high version)

Boîtiers EPIC® H-A: capot prolongateur (sortie verticale, simple levier, version haute)

H-A 10

Artikel part article	Art.Nr. part No. N° art.	Art.Nr.: EP part No.: EP N° art.: EP	PG	L	L1	L2	L3	L4	B	B1	B2	B3	B4	B5	H	H1	H2	S	d
H-A 10 TBFH-LB 21	70450400	70451400	21	63	74,4	71,4			29,5						62				36,5

Einsätze / Inserts / Inserts: 1.1: H-A 10 / 1.2: STA 14 / 1.6: H-D 15

Deckel / Cover / Couvercle: 5.1: H-A 10

Kabelverschraubung / Cable gland / Presse-étoupe: 4.1

H-A 16

Artikel part article	Art.Nr. part No. N° art.	Art.Nr.: EP part No.: EP N° art.: EP	PG	L	L1	L2	L3	L4	B	B1	B2	B3	B4	B5	H	H1	H2	S	d
H-A 16 TBFH-LB 16	70480200	70481200	16	79	90,4	87,8			29,5						67				36,5
H-A 16 TBFH-LB 21	70480400	70481400	21																

Einsätze / Inserts / Inserts: 1.1: H-A 16 / 1.2: STA 20 / 1.6: H-D 25

Deckel / Cover / Couvercle: 5.1: H-A 16

Kabelverschraubung / Cable gland / Presse-étoupe: 4.1

3.1 EPIC® D A - V I N C I H - A

Kupplungsgehäuse / *Cable coupler hood* / *Capot prolongateur*

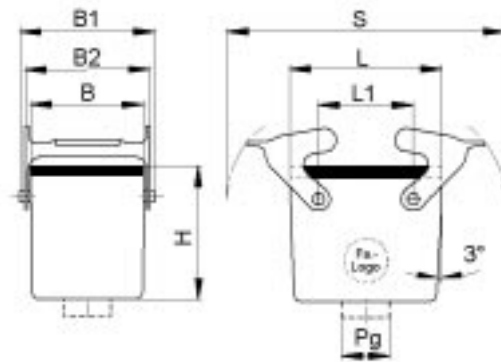

EPIC® H-A Gehäuse: Kupplungsgehäuse (Kabeleingang gerade, Querbügel)

EPIC® H-A housings: cable coupler hood (top entry, double locking lever)

Boîtiers EPIC® H-A: capot prolongateur (sortie verticale, double levier)

H-A 32

Artikel <i>part</i> <i>article</i>	Art.Nr. <i>part No.</i> <i>N° art.</i>	Art.Nr.: EP <i>part No: EP</i> <i>N° art.: EP</i>	PG	L	L1	L2	L3	L4	B	B1	B2	B3	B4	B5	H	H1	H2	S	d
H-A 32 TBF 21	10588000	70511000	21		82	49,6			56	70,8	66				76,5				124,5
H-A 32 TBF 29	10588500	70511200	29																

Einsätze / *Inserts* / *Inserts*: 1.1: H-A 32 / 1.2: 2 x STA 20 / 1.6: H-D 50

Deckel / *Cover* / *Couvercle*: 5.1: H-A 32

Kabelverschraubung / *Cable gland* / *Presse-étoupe*: 4.1

3.2 EPIC® D A - V I N C I H - B

Tüllengehäuse / Hood / Capot

Solide Bauform und ein umfangreiches Programm an passenden Einsätzen sind die markanten Merkmale dieses Gehäuses. Diese Bauform läßt sich aus dem Industriestandard nicht mehr wegdenken. Die Gehäuse der H-B Serie gibt es in sechs verschiedenen Gehäusegrößen.

The striking characteristics of these mount bases are a sturdy construction and a comprehensive range of corresponding inserts. This style is used in all industrial applications. The H-B series housings are available in six different sizes.

Une forme de construction solide et un programme important d'inserts adéquats sont les caractéristiques marquantes de ce boîtier. Cette forme de construction est devenue indispensable au standard industriel. Les boîtiers de la série H-B sont disponibles en six tailles différentes.



3.2 EPIC® D A - V I N C I H - B

Tüllengehäuse / Hood / Capot

Technische Daten:

Vorschriften: DIN 43652

Temperaturbereich: -40°C - +125°C

Schutzart: IP 65

Werkstoff: H-B 6 – 48: Aluminiumlegierung, pulverbeschichtet

Technical Data

Specifications: DIN 43652

Temperature range: : -40°C - +125°C

Protection class: IP 65

Material: H-B 6 – 48: aluminium alloy, powder coated

Caractéristiques techniques

Règlements: DIN 43652

Gamme de température: : -40°C - +125°C

Degré de protection: IP 65

Matière: H-B 6 – 48: Alliage aluminium, recouvert par pulvérisation



EPIC®

Aluminiumlegierung, pulverbeschichtet (grau), Bügel und Bolzen aus verzinktem Stahl

Aluminium alloy, powder coated (grey), locking levers and bolts made of zinc plated steel

Alliage aluminium, recouvert par pulvérisation (grise), leviers et ergots acier recouvert par zinc

Für den industriellen Einsatz in anspruchsvoller Umgebung.

For industrial applications in demanding environments.

Pour une exploitation industrielle dans un environnement exigeant.



EPIC® EP: (Environmental Protected)

Aluminiumlegierung, pulverbeschichtet (schwarz), Bügel und Bolzen aus Edelstahl

Aluminium alloy, powder coated (black), locking levers and bolts made of stainless steel

Alliage aluminium, recouvert par pulvérisation (noir), leviers et ergots acier inox

Für den industriellen Einsatz in stark beanspruchter Umgebung mit aggressiver Atmosphäre.

For industrial applications in extremely demanding environments with aggressive atmospheres.

Pour l'exploitation industrielle dans un environnement très sollicité à atmosphère agressive.



EPIC® Eco

Aluminiumlegierung, unbeschichtet, Bügel und Bolzen aus verzinktem Stahl

Aluminium alloy, uncoated, locking levers and bolts made of zinc plated steel

Alliage aluminium, sans pulvérisation, leviers et ergots acier recouvert par zinc

EMV - geschützt. Für den industriellen Einsatz in anspruchsvoller Umgebung.

EMC-protected for industrial applications in demanding environments.

Protection CEM. Pour une exploitation industrielle dans un environnement exigeant.

3.2 EPIC® D A - V I N C I H - B

Tüllengehäuse / Hood / Capot

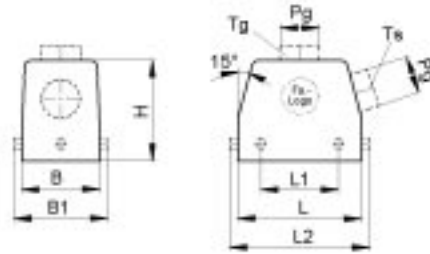

EPIC® H-B Gehäuse: Tüllengehäuse (Kabeleingang gerade, Bolzen für Längsbügel)
EPIC® H-B housings: hood (top entry, bolts for single locking lever)
Boîtiers EPIC® H-B: capot (sortie verticale, ergots pour simple levier)

H-B 6

Artikel part article	Art.Nr. part No. N° art.	Art.Nr.: EP part No.: EP N° art.: EP	PG	L	L1	L2	L3	L4	B	B1	B2	B3	B4	B5	H	H1	H2	S	d
H-B 6 TG 13,5	10011000*	70021600	13,5	60		74,8			43						52				
H-B 6 TG 16	10021000*	70021000	16																

Einsätze / Inserts / Inserts: 1.3: H-BE 6 / 1.7: H-DD 24 / 1.8: MC 6
 Deckel / Cover / Couvercle: 5.1: H-BE 6
 Kabelverschraubung / Cable gland / Presse-étoupe: 4.1

H-B 10

Artikel part article	Art.Nr. part No. N° art.	Art.Nr.: EP part No.: EP N° art.: EP	PG	L	L1	L2	L3	L4	B	B1	B2	B3	B4	B5	H	H1	H2	S	d
H-B 10 TG-RO 16	10040900*	70049000	16	73		90			43						52				
H-B 10 TG-RO 21	10040700	70049600	21																

Einsätze / Inserts / Inserts: 1.3: H-BE 10 / 1.5: H-BVE 3 / 1.7: H-DD 42 / 1.8: MC 10
 Kabelverschraubung / Cable gland / Presse-étoupe: 4.1

H-B 16

Artikel part article	Art.Nr. part No. N° art.	Art.Nr.: EP part No.: EP N° art.: EP	PG	L	L1	L2	L3	L4	B	B1	B2	B3	B4	B5	H	H1	H2	S	d
H-B 16 TG-RO 21	10080900*	70099000	21	93,3		110			43						61				

Einsätze / Inserts / Inserts: 1.3: H-BE 16 / 1.4: H-BS 6 / 1.5: H-BVE 6 / 1.6: H-D 40 / 1.7: H-DD 72 / 1.8: MC 16
 Kabelverschraubung / Cable gland / Presse-étoupe: 4.1

H-B 24

Artikel part article	Art.Nr. part No. N° art.	Art.Nr.: EP part No.: EP N° art.: EP	PG	L	L1	L2	L3	L4	B	B1	B2	B3	B4	B5	H	H1	H2	S	d
H-B 24 TG-RO 21	10121900*	70149000	21	120		137			43						61				
H-B 24 TG-RO 29	10111900*	70149200	29																

Einsätze / Inserts / Inserts: 1.3: H-BE 48 / 1.5: H-BVE 10 / 1.6: H-D 64 / 1.7: H-DD 108 / 1.8: MC 24
 Kabelverschraubung / Cable gland / Presse-étoupe: 4.1

H-B 48

Artikel part article	Art.Nr. part No. N° art.	Art.Nr.: EP part No.: EP N° art.: EP	PG	L	L1	L2	L3	L4	B	B1	B2	B3	B4	B5	H	H1	H2	S	d
H-B 48 TG 29	10155000*	-	29																
H-B 48 TG 36	10156000*	-	36	132		152			90						105				
H-B 48 TG 42	10157000*	-	42																

Einsätze / Inserts / Inserts: 1.3: H-BE 48 / 1.5: 2 x H-BVE 10 / 1.6: H-D 128 / 1.7: H-DD 216 / 1.8: 2 x MC 24
 Kabelverschraubung / Cable gland / Presse-étoupe: 4.1

3.2 EPIC® D A - V I N C I H - B

Tüllengehäuse / Hood / Capot

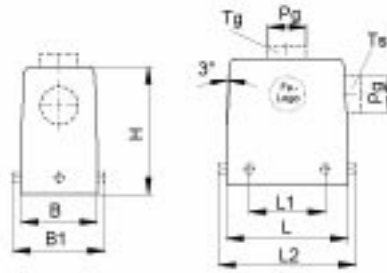

EPIC® H-B Gehäuse: Tüllengehäuse (Kabeleingang gerade, Bolzen für Längsbügel, hohe Bauform)
EPIC® H-B housings: hood (top entry, bolts for single locking lever, high version)
Boîtiers EPIC® H-B: capot (sortie verticale, ergots pour simple levier, version haute)

H-B 6

Artikel part article	Art.Nr. part No. N° art.	Art.Nr.: EP part No: EP N° art.: EP	PG	L	L1	L2	L3	L4	B	B1	B2	B3	B4	B5	H	H1	H2	S	d
H-B 6 TGH 21	70020200	70021200	21			74,8			43						72				
H-B 6 TGH 29	70020400	70021400	29	60															

Einsätze / Inserts / Inserts: 1.3: H-BE 6 / 1.7: H-DD 24 / 1.8: MC 6

Deckel / Cover / Couvercle: 5.1: H-B 6

Kabelverschraubung / Cable gland / Presse-étoupe: 4.1

H-B 10

Artikel part article	Art.Nr. part No. N° art.	Art.Nr.: EP part No: EP N° art.: EP	PG	L	L1	L2	L3	L4	B	B1	B2	B3	B4	B5	H	H1	H2	S	d
H-B 10 TGH-RO 21	70044200	70049200	21		73	90			43						72				
H-B 10 TGH-RO 29	70044400	70049400	29																

Einsätze / Inserts / Inserts: 1.3: H-BE 10 / 1.5: H-BVE 3 / 1.7: H-DD 42 / 1.8: MC 10

Kabelverschraubung / Cable gland / Presse-étoupe: 4.1

H-B 16

Artikel part article	Art.Nr. part No. N° art.	Art.Nr.: EP part No: EP N° art.: EP	PG	L	L1	L2	L3	L4	B	B1	B2	B3	B4	B5	H	H1	H2	S	d
H-B 16 TGH-RO 21	70094200	70099200	21		93,3	110			43										76
H-B 16 TGH-RO 29	70094400	70099400	29																

Einsätze / Inserts / Inserts: 1.3: H-BE 16 / 1.4: H-BS 6 / 1.5: H-BVE 6 / 1.6: H-D 40 / 1.7: H-DD 72 / 1.8: MC 16

Kabelverschraubung / Cable gland / Presse-étoupe: 4.1

H-B 24

Artikel part article	Art.Nr. part No. N° art.	Art.Nr.: EP part No: EP N° art.: EP	PG	L	L1	L2	L3	L4	B	B1	B2	B3	B4	B5	H	H1	H2	S	d
H-B 24 TGH-RO 21	70144400	70149400	21		120	137			43						76				
H-B 24 TGH-RO 29	70144600	70149600	29																

Einsätze / Inserts / Inserts: 1.3: H-BE 24 / 1.5: H-BVE 10 / 1.6: H-D 64 / 1.7: H-DD 108 / 1.8: MC 24

Kabelverschraubung / Cable gland / Presse-étoupe: 4.1

3.2 EPIC® D A - V I N C I H - B

Tüllengehäuse / Hood / Capot

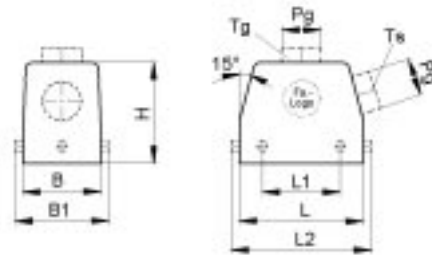

EPIC® H-B Gehäuse: Tüllengehäuse (Kabeleingang seitlich, Bolzen für Längsbügel)

EPIC® H-B housings: hood (side entry, bolts for single locking lever)

Boîtiers EPIC® H-B: capot (sortie latérale, ergots pour simple levier)

H-B 6

Artikel part article	Art.Nr. part No. N° art.	Art.Nr.: EP part No: EP N° art.: EP	PG	L	L1	L2	L3	L4	B	B1	B2	B3	B4	B5	H	H1	H2	S	d
H-B 6 TS 13,5	10012000*	70023600	13,5	60		74,8			43						52				
H-B 6 TS 16	10022000*	70023000	16																

Einsätze / Inserts / Inserts: 1.3: H-BE 6 / 1.7: H-DD 24 / 1.8: MC 6

Deckel / Cover / Couvercle: 5.1: H-B 6

Kabelverschraubung / Cable gland / Presse-étoupe: 4.1

H-B 10

Artikel part article	Art.Nr. part No. N° art.	Art.Nr.: EP part No: EP N° art.: EP	PG	L	L1	L2	L3	L4	B	B1	B2	B3	B4	B5	H	H1	H2	S	d
H-B 10 TS-RO 16	10042900*	70059000	16	73		90			43						52				
H-B 10 TS-RO 21	10042800*	70059600	21																

Einsätze / Inserts / Inserts: 1.3: H-BE 10 / 1.5: H-BVE 3 / 1.7: H-DD 42 / 1.8: MC 10

Kabelverschraubung / Cable gland / Presse-étoupe: 4.1

H-B 16

Artikel part article	Art.Nr. part No. N° art.	Art.Nr.: EP part No: EP N° art.: EP	PG	L	L1	L2	L3	L4	B	B1	B2	B3	B4	B5	H	H1	H2	S	d
H-B 16 TS-RO 21	10082900*	70109000	21	93,3		110			43						61				
H-B 16 TS-RO 29	10092900*		29																

Einsätze / Inserts / Inserts: 1.3: H-BE 16 / 1.4: H-BS 6 / 1.5: H-BVE 6 / 1.6: H-D 40 / 1.7: H-DD 72 / 1.8: MC 16

Kabelverschraubung / Cable gland / Presse-étoupe: 4.1

H-B 24

Artikel part article	Art.Nr. part No. N° art.	Art.Nr.: EP part No: EP N° art.: EP	PG	L	L1	L2	L3	L4	B	B1	B2	B3	B4	B5	H	H1	H2	S	d
H-B 24 TS-RO 21	10113900*	70159000	21	120		137			43						61				
H-B 24 TS-RO 29	10123900*	70159200	29																

Einsätze / Inserts / Inserts: 1.3: H-BE 24 / 1.5: H-BVE 10 / 1.6: H-D 64 / 1.7: H-DD 108 / 1.8: MC 24

Kabelverschraubung / Cable gland / Presse-étoupe: 4.1

H-B 48

Artikel part article	Art.Nr. part No. N° art.	Art.Nr.: EP part No: EP N° art.: EP	PG	L	L1	L2	L3	L4	B	B1	B2	B3	B4	B5	H	H1	H2	S	d
H-B 48 TS 29	10158000*	-	29																
H-B 48 TS 36	10159000*	-	36	132		152			90						105				
H-B 48 TS 42	10160000	-	42																

Einsätze / Inserts / Inserts: 1.3: H-BE 48 / 1.5: 2 x H-BVE 10 / 1.6: H-D 128 / 1.7: H-DD 216 / 1.8: 2 x MC 24

Kabelverschraubung / Cable gland / Presse-étoupe: 4.1

3.2 EPIC® D A - V I N C I H - B

Tüllengehäuse / Hood / Capot

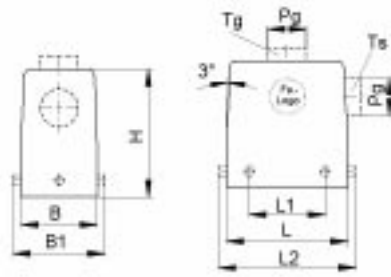

EPIC® H-B Gehäuse: Tüllengehäuse (Kabeleingang seitlich, Bolzen für Längsbügel, hohe Bauform)
EPIC® H-B housings: hood (side entry, bolts for single locking lever, high version)
Boîtiers EPIC® H-B: capot (sortie latérale, ergots pour simple levier, version haute)

H-B 6

Artikel part article	Art.Nr. part No. N° art.	Art.Nr.: EP part No: EP N° art.: EP	PG	L	L1	L2	L3	L4	B	B1	B2	B3	B4	B5	H	H1	H2	S	d
H-B 6 TSH 21	70022200	70023200	21			60			43						72				
H-B 6 TSH 29	70022400	70023400	29																

Einsätze / Inserts / Inserts: 1.3: H-BE 6 / 1.7: H-DD 24 / 1.8: MC 6
 Deckel / Cover / Couvercle: 5.1: H-B 6
 Kabelverschraubung / Cable gland / Presse-étoupe: 4.1

H-B 10

Artikel part article	Art.Nr. part No. N° art.	Art.Nr.: EP part No: EP N° art.: EP	PG	L	L1	L2	L3	L4	B	B1	B2	B3	B4	B5	H	H1	H2	S	d
H-B 10 TSH-RO 21	70054200	70059200	21		73	90			43						72				
H-B 10 TSH-RO 29	70054400	70059400	29																

Einsätze / Inserts / Inserts: 1.3: H-BE 10 / 1.5: H-BVE 3 / 1.7: H-DD 42 / 1.8: MC 10
 Kabelverschraubung / Cable gland / Presse-étoupe: 4.1

H-B 16

Artikel part article	Art.Nr. part No. N° art.	Art.Nr.: EP part No: EP N° art.: EP	PG	L	L1	L2	L3	L4	B	B1	B2	B3	B4	B5	H	H1	H2	S	d
H-B 16 TSH-RO 21	70104200	70109200	21			93,3		110	43						76				
H-B 16 TSH-RO 29	70104400	70109400	29																

Einsätze / Inserts / Inserts: 1.3: H-BE 16 / 1.4: H-BS 6 / 1.5: H-BVE 6 / 1.6: H-D 40 / 1.7: H-DD 72 / 1.8: MC 16
 Kabelverschraubung / Cable gland / Presse-étoupe: 4.1

H-B 24

Artikel part article	Art.Nr. part No. N° art.	Art.Nr.: EP part No: EP N° art.: EP	PG	L	L1	L2	L3	L4	B	B1	B2	B3	B4	B5	H	H1	H2	S	d
H-B 24 TSH-RO 21	70154400	70159400	21		120	137			43						76				
H-B 24 TSH-RO 29	70154600	70159600	29																

Einsätze / Inserts / Inserts: 1.3: H-BE 24 / 1.5: H-BVE 10 / 1.6: H-D 64 / 1.7: H-DD 108 / 1.8: MC 24
 Kabelverschraubung / Cable gland / Presse-étoupe: 4.1

3.2 EPIC® D A - V I N C I H - B

Tüllengehäuse / Hood / Capot

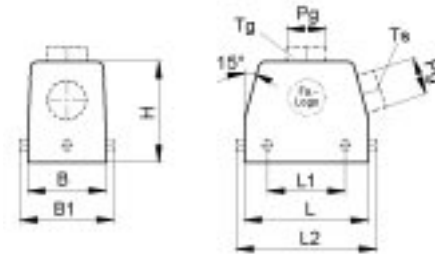

EPIC® H-B Gehäuse: Tüllengehäuse (Kabeleingang gerade, Bolzen für Querbügel)

EPIC® H-B housings: hood (top entry, bolts for double locking lever)

Boîtiers EPIC® H-B: capot (sortie verticale, ergots pour double levier)

H-B 10

Artikel part article	Art.Nr. part No. N° art.	Art.Nr.: EP part No: EP N° art.: EP	PG	L	L1	L2	L3	L4	B	B1	B2	B3	B4	B5	H	H1	H2	S	d
H-B 10 TG 16	10040000*	70051000	16		73	27			43	57,8					52				
H-B 10 TG 21	10040100*	70051200	21																

Einsätze / Inserts / Inserts: 1.3: H-BE 10 / 1.5: H-BVE 3 / 1.7: H-DD 42 / 1.8: MC 10

Deckel / Cover / Couvercle: 5.1: H-B 10

Kabelverschraubung / Cable gland / Presse-étoupe: 4.1

H-B 16

Artikel part article	Art.Nr. part No. N° art.	Art.Nr.: EP part No: EP N° art.: EP	PG	L	L1	L2	L3	L4	B	B1	B2	B3	B4	B5	H	H1	H2	S	d
H-B 16 TG 21	10080000*	70101000	21	93,3	47,5				43	57,8					61				
H-B 16 TG 29	10090000*	-	29																

Einsätze / Inserts / Inserts: 1.3: H-BE 16 / 1.4: H-BS 6 / 1.5: H-BVE 6 / 1.6: H-D 40 / 1.7: H-DD 72 / 1.8: MC 16

Deckel / Cover / Couvercle: 5.1: H-B 16

Kabelverschraubung / Cable gland / Presse-étoupe: 4.1

H-B 24

Artikel part article	Art.Nr. part No. N° art.	Art.Nr.: EP part No: EP N° art.: EP	PG	L	L1	L2	L3	L4	B	B1	B2	B3	B4	B5	H	H1	H2	S	d
H-B 24 TG 21	10121000*	70151000	21	120	74				43	57,8					61				
H-B 24 TG 29	10111000*	70151200	29																

Einsätze / Inserts / Inserts: 1.3: H-BE 24 / 1.5: H-BVE 10 / 1.6: H-D 64 / 1.7: H-DD 108 / 1.8: MC 24

Deckel / Cover / Couvercle: 5.1: H-B 24

Kabelverschraubung / Cable gland / Presse-étoupe: 4.1

3.2 EPIC® D A - V I N C I H - B

Tüllengehäuse / Hood / Capot

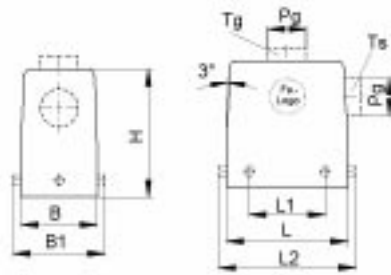

EPIC® H-B Gehäuse: Tüllengehäuse (Kabeleingang gerade, Bolzen für Querbügel, hohe Bauform)
EPIC® H-B housings: hood (top entry, bolts for double locking lever, high version)
Boîtiers EPIC® H-B: capot (sortie verticale, ergots pour double levier, version haute)

H-B 10

Artikel part article	Art.Nr. part No. N° art.	Art.Nr.: EP part No: EP N° art.: EP	PG	L	L1	L2	L3	L4	B	B1	B2	B3	B4	B5	H	H1	H2	S	d
H-B 10 TGH 21	70050400	70051400	21		73	27			43	57,8					72				
H-B 10 TGH 29	70050600	70051600	29																

Einsätze / Inserts / Inserts: 1.3: H-BE 10 / 1.5: H-BVE 3 / 1.7: H-DD 42 / 1.8: MC 10

Deckel / Cover / Couvercle: 5.1: H-B 10

Kabelverschraubung / Cable gland / Presse-étoupe: 4.1

H-B 16

Artikel part article	Art.Nr. part No. N° art.	Art.Nr.: EP part No: EP N° art.: EP	PG	L	L1	L2	L3	L4	B	B1	B2	B3	B4	B5	H	H1	H2	S	d
H-B 16 TGH 21	70100200	70101200	21		93,3	47,5			43	57,8					76				
H-B 16 TGH 29	70100400*	70101400	29																

Einsätze / Inserts / Inserts: 1.3: H-BE 16 / 1.4: H-BS 6 / 1.5: H-BVE 6 / 1.6: H-D 40 / 1.7: H-DD 72 / 1.8: MC 16

Deckel / Cover / Couvercle: 5.1: H-B 16

Kabelverschraubung / Cable gland / Presse-étoupe: 4.1

H-B 24

Artikel part article	Art.Nr. part No. N° art.	Art.Nr.: EP part No: EP N° art.: EP	PG	L	L1	L2	L3	L4	B	B1	B2	B3	B4	B5	H	H1	H2	S	d
H-B 24 TGH 21	70150400	70151400	21		120	74			43	57,8					76				
H-B 24 TGH 29	70150600	70151600	29																

Einsätze / Inserts / Inserts: 1.3: H-BE 24 / 1.5: H-BVE 10 / 1.6: H-D 64 / 1.7: H-DD 108 / 1.8: MC 24 / 1.9: TB-H-BE 21, TB-H-D 64

Deckel / Cover / Couvercle: 5.1: H-B 24

Kabelverschraubung / Cable gland / Presse-étoupe: 4.1

H-B 32

Artikel part article	Art.Nr. part No. N° art.	Art.Nr.: EP part No: EP N° art.: EP	PG	L	L1	L2	L3	L4	B	B1	B2	B3	B4	B5	H	H1	H2	S	d
H-B 32 TG 29	10134000*	-	29		93,5	64,5			79	89,5					95				

Einsätze / Inserts / Inserts: 1.3: H-BE 32 / 1.4: H-BS 12 / 1.6: H-D 80 / 1.7: H-DD 144 / 1.8: 2 x MC 16

Kabelverschraubung / Cable gland / Presse-étoupe: 4.1

3.2 EPIC® D A - V I N C I H - B

Tüllengehäuse / Hood / Capot

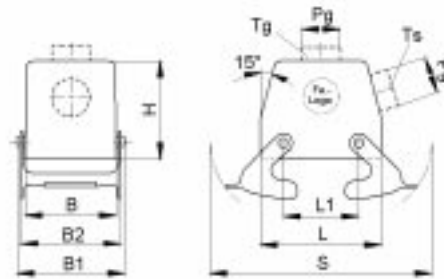

EPIC® H-B Gehäuse: Tüllengehäuse (Kabeleingang gerade, Querbügel)

EPIC® H-B housings: hood (top entry, double locking lever)

Boîtiers EPIC® H-B: capot (sortie verticale, double levier)

H-B 10

Artikel part article	Art.Nr. part No. N° art.	Art.Nr.: EP part No: EP N° art.: EP	PG	L	L1	L2	L3	L4	B	B1	B2	B3	B4	B5	H	H1	H2	S	d
H-B 10 TGB 16	10041000*	70056000	16	73	27				43	57,8	53				52			116	

Einsätze / Inserts / Inserts: 1.3: H-BE 10 / 1.5: H-BVE 3 / 1.7: H-DD 42 / 1.8: MC 10

Deckel / Cover / Couvercle: 5.1: H-B 10

Kabelverschraubung / Cable gland / Presse-étoupe: 4.1

H-B 16

Artikel part article	Art.Nr. part No. N° art.	Art.Nr.: EP part No: EP N° art.: EP	PG	L	L1	L2	L3	L4	B	B1	B2	B3	B4	B5	H	H1	H2	S	d
H-B 16 TGB 21	10081000*	70106000	21	93,3	47,5				43	57,8	53				61			136,5	

Einsätze / Inserts / Inserts: 1.3: H-BE 16 / 1.4: H-BS 6 / 1.5: H-BVE 6 / 1.6: H-D 40 / 1.7: H-DD 72 / 1.8: MC 16

Deckel / Cover / Couvercle: 5.1: H-B 16

Kabelverschraubung / Cable gland / Presse-étoupe: 4.1

H-B 24

Artikel part article	Art.Nr. part No. N° art.	Art.Nr.: EP part No: EP N° art.: EP	PG	L	L1	L2	L3	L4	B	B1	B2	B3	B4	B5	H	H1	H2	S	d
H-B 24 TGB 21	10122000	70156000	21	120	74				43	57,8	53				61			163	
H-B 24 TGB 29	10112000*	70156200	29																

Einsätze / Inserts / Inserts: 1.3: H-BE 24 / 1.5: H-BVE 10 / 1.6: H-D 64 / 1.7: H-DD 108 / 1.8: MC 24

Deckel / Cover / Couvercle: 5.1: H-B 24

Kabelverschraubung / Cable gland / Presse-étoupe: 4.1

3.2 EPIC® D A - V I N C I H - B

Tüllengehäuse / Hood / Capot

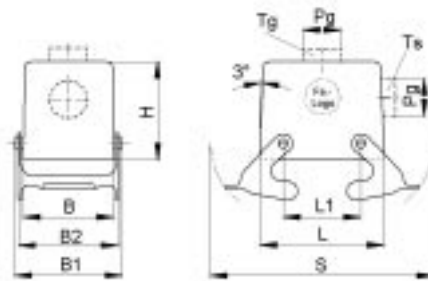

EPIC® H-B Gehäuse: Tüllengehäuse (Kabeleingang gerade, Querbügel, hohe Bauform)
EPIC® H-B housings: hood (top entry, double locking lever, high version)
Boîtiers EPIC® H-B: capot (sortie verticale, double levier, version haute)

H-B 10

Artikel part article	Art.Nr. part No. N° art.	Art.Nr.: EP part No.: EP N° art.: EP	PG	L	L1	L2	L3	L4	B	B1	B2	B3	B4	B5	H	H1	H2	S	d
H-B 10 TGBH 21	70055200	70056200	21		73	27			43	57,8	53				72				116
H-B 10 TGBH 29	70055400	70056400	29																

Einsätze / Inserts / Inserts: 1.3: H-BE 10 / 1.5: H-BVE 3 / 1.7: H-DD 42 / 1.8: MC 10

Deckel / Cover / Couvercle: 5.1: H-B 10

Kabelverschraubung / Cable gland / Presse-étoupe: 4.1

H-B 16

Artikel part article	Art.Nr. part No. N° art.	Art.Nr.: EP part No.: EP N° art.: EP	PG	L	L1	L2	L3	L4	B	B1	B2	B3	B4	B5	H	H1	H2	S	d
H-B 16 TGBH 21	70105200	70106200	21		93,3	47,5			43	57,8	53				76				136,5
H-B 16 TGBH 29	70105400	70106400	29																

Einsätze / Inserts / Inserts: 1.3: H-BE 16 / 1.4: H-BS 6 / 1.5: H-BVE 6 / 1.6: H-D 40 / 1.7: H-DD 72 / 1.8: MC 16

Deckel / Cover / Couvercle: 5.1: H-B 16

Kabelverschraubung / Cable gland / Presse-étoupe: 4.1

H-B 24

Artikel part article	Art.Nr. part No. N° art.	Art.Nr.: EP part No.: EP N° art.: EP	PG	L	L1	L2	L3	L4	B	B1	B2	B3	B4	B5	H	H1	H2	S	d
H-B 24 TGBH 21	70155400	70156400	21		120	74			43	57,8	53				76				163
H-B 24 TGBH 29	70155600	70156600	29																

Einsätze / Inserts / Inserts: 1.3: H-BE 24 / 1.5: H-BVE 10 / 1.6: H-D 64 / 1.7: H-DD 108 / 1.8: MC 24

Deckel / Cover / Couvercle: 5.1: H-B 24

Kabelverschraubung / Cable gland / Presse-étoupe: 4.1

H-B 32

Artikel part article	Art.Nr. part No. N° art.	Art.Nr.: EP part No.: EP N° art.: EP	PG	L	L1	L2	L3	L4	B	B1	B2	B3	B4	B5	H	H1	H2	S	d
H-B 32 TGB 29	70205000	-	29		93,5	64,5			79	93,8	87,8				95				136,5

Einsätze / Inserts / Inserts: 1.3: H-BE 32 / 1.4: H-BS 12 / 1.6: H-D 80 / 1.7: H-DD 144 / 1.8: 2 x MC 16

Kabelverschraubung / Cable gland / Presse-étoupe: 4.1

3.2 EPIC® D A - V I N C I H - B

Tüllengehäuse / Hood / Capot

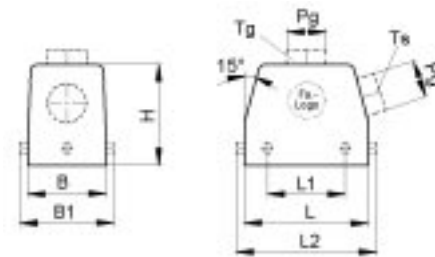

EPIC® H-B Gehäuse: Tüllengehäuse (Kabeleingang seitlich, Bolzen für Querbügel)

EPIC® H-B housings: hood (side entry, bolts for double locking lever)

Boîtiers EPIC® H-B: capot (sortie latérale, ergots pour double levier)

H-B 10

Artikel part article	Art.Nr. part No. N° art.	Art.Nr.: EP part No.: EP N° art.: EP	PG	L	L1	L2	L3	L4	B	B1	B2	B3	B4	B5	H	H1	H2	S	d
H-B 10 TS 16	10042000*	70053000	16		73	27			43	57,8					52				
H-B 10 TS 21	10042100*	70053200	21																

Einsätze / Inserts / Inserts: 1.3: H-BE 10 / 1.5: H-BVE 3 / 1.7: H-DD 42 / 1.8: MC 10

Deckel / Cover / Couvercle: 5.1: H-B 10

Kabelverschraubung / Cable gland / Presse-étoupe: 4.1

H-B 16

Artikel part article	Art.Nr. part No. N° art.	Art.Nr.: EP part No.: EP N° art.: EP	PG	L	L1	L2	L3	L4	B	B1	B2	B3	B4	B5	H	H1	H2	S	d
H-B 16 TS 21	10082000*	70103000	21	93,3	47,5				43	57,8					61				
H-B 16 TS 29	10092000*	-	29																

Einsätze / Inserts / Inserts: 1.3: H-BE 16 / 1.4: H-BS 6 / 1.5: H-BVE 6 / 1.6: H-D 40 / 1.7: H-DD 72 / 1.8: MC 16

Deckel / Cover / Couvercle: 5.1: H-B 16

Kabelverschraubung / Cable gland / Presse-étoupe: 4.1

H-B 24

Artikel part article	Art.Nr. part No. N° art.	Art.Nr.: EP part No.: EP N° art.: EP	PG	L	L1	L2	L3	L4	B	B1	B2	B3	B4	B5	H	H1	H2	S	d
H-B 24 TS 21	10113000*	70153000	21	120	74				43	57,8					61				
H-B 24 TS 29	10123000*	70153200	29																

Einsätze / Inserts / Inserts: 1.3: H-BE 24 / 1.5: H-BVE 10 / 1.6: H-D 64 / 1.7: H-DD 108 / 1.8: MC 24

Deckel / Cover / Couvercle: 5.1: H-B 24

Kabelverschraubung / Cable gland / Presse-étoupe: 4.1

3.2 EPIC® D A - V I N C I H - B

Tüllengehäuse / Hood / Capot

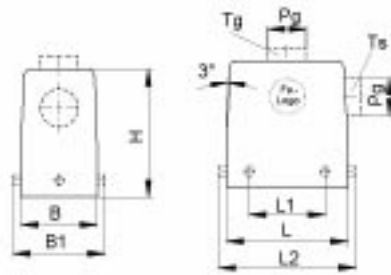

EPIC® H-B Gehäuse: Tüllengehäuse (Kabeleingang seitlich, Bolzen für Querbügel, hohe Bauform)
EPIC® H-B housings: hood (side entry, bolts for double locking lever, high version)
Boîtiers EPIC® H-B: capot (sortie latérale, ergots pour double levier, version haute)

H-B 10

Artikel part article	Art.Nr. part No. N° art.	Art.Nr.: EP part No: EP N° art.: EP	PG	L	L1	L2	L3	L4	B	B1	B2	B3	B4	B5	H	H1	H2	S	d
H-B 10 TSH 21	70052400	70053400	21		73	27			43	57,8					72				
H-B 10 TSH 29	70052600	70053600	29																

Einsätze / Inserts / Inserts: 1.3: H-BE 10 / 1.5: H-BVE 3 / 1.7: H-DD 42 / 1.8: MC 10
 Deckel / Cover / Couvercle: 5.1: H-B 10
 Kabelverschraubung / Cable gland / Presse-étoupe: 4.1

H-B 16

Artikel part article	Art.Nr. part No. N° art.	Art.Nr.: EP part No: EP N° art.: EP	PG	L	L1	L2	L3	L4	B	B1	B2	B3	B4	B5	H	H1	H2	S	d
H-B 16 TSH 21	70102200	70103200	21		93,3	47,5			43	57,8					76				
H-B 16 TSH 29	70102400*	70103400	29																

Einsätze / Inserts / Inserts: 1.3: H-BE 16 / 1.4: H-BS 6 / 1.5: H-BVE 6 / 1.6: H-D 40 / 1.7: H-DD 72 / 1.8: MC 16
 Deckel / Cover / Couvercle: 5.1: H-B 16
 Kabelverschraubung / Cable gland / Presse-étoupe: 4.1

H-B 24

Artikel part article	Art.Nr. part No. N° art.	Art.Nr.: EP part No: EP N° art.: EP	PG	L	L1	L2	L3	L4	B	B1	B2	B3	B4	B5	H	H1	H2	S	d
H-B 24 TSH 21	70152400	70153400	21		120	74			43	57,8					76				
H-B 24 TSH 29	70152600*	70153600	29																

Einsätze / Inserts / Inserts: 1.3: H-BE 24 / 1.5: H-BVE 10 / 1.6: H-D 64 / 1.7: H-DD 108 / 1.8: MC 24
 Deckel / Cover / Couvercle: 5.1: H-B 24
 Kabelverschraubung / Cable gland / Presse-étoupe: 4.1

H-B 32

Artikel part article	Art.Nr. part No. N° art.	Art.Nr.: EP part No: EP N° art.: EP	PG	L	L1	L2	L3	L4	B	B1	B2	B3	B4	B5	H	H1	H2	S	d
H-B 32 TS 21	10135000*	-	21		93,5	64,5			79	89,5					95				
H-B 32 TS 29	10136000*	-	29																

Einsätze / Inserts / Inserts: 1.3: H-BE 32 / 1.4: H-BS 12 / 1.6: H-D 80 / 1.7: H-DD 144 / 1.8: 2 x MC 16
 Kabelverschraubung / Cable gland / Presse-étoupe: 4.1

3.2 EPIC® D A - V I N C I H - B

Tüllengehäuse / Hood / Capot

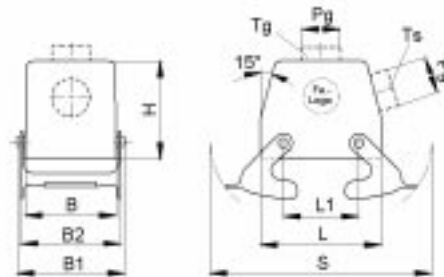

EPIC® H-B Gehäuse: Tüllengehäuse (Kabeleingang seitlich, Querbügel)

EPIC® H-B housings: hood (side entry, double locking lever)

Boîtiers EPIC® H-B: capot (sortie latérale, double levier)

H-B 10

Artikel part article	Art.Nr. part No. N° art.	Art.Nr.: EP part No: EP N° art.: EP	PG	L	L1	L2	L3	L4	B	B1	B2	B3	B4	B5	H	H1	H2	S	d
H-B 10 TSB 16	10045000*	70058000	16	73	27				43	57,8	53				52				116

Einsätze / Inserts / Inserts: 1.3: H-BE 10 / 1.5: H-BVE 3 / 1.7: H-DD 42 / 1.8: MC 10

Deckel / Cover / Couvercle: 5.1: H-B 10

Kabelverschraubung / Cable gland / Presse-étoupe: 4.1

H-B 16

Artikel part article	Art.Nr. part No. N° art.	Art.Nr.: EP part No: EP N° art.: EP	PG	L	L1	L2	L3	L4	B	B1	B2	B3	B4	B5	H	H1	H2	S	d
H-B 16 TSB 21	10083000*	70108000	21	93,3	47,5				43	57,8	53				61				136,5

Einsätze / Inserts / Inserts: 1.3: H-BE 16 / 1.4: H-BS 6 / 1.5: H-BVE 6 / 1.6: H-D 40 / 1.7: H-DD 72 / 1.8: MC 16

Deckel / Cover / Couvercle: 5.1: H-B 16

Kabelverschraubung / Cable gland / Presse-étoupe: 4.1

H-B 24

Artikel part article	Art.Nr. part No. N° art.	Art.Nr.: EP part No: EP N° art.: EP	PG	L	L1	L2	L3	L4	B	B1	B2	B3	B4	B5	H	H1	H2	S	d
H-B 24 TSB 21	10114000*	70158000	21	120	74				43	57,8	53				61				163
H-B 24 TSB 29	10124000	70158200	29																

Einsätze / Inserts / Inserts: 1.3: H-BE 24 / 1.5: H-BVE 10 / 1.6: H-D 64 / 1.7: H-DD 108 / 1.8: MC 24

Deckel / Cover / Couvercle: 5.1: H-B 24

Kabelverschraubung / Cable gland / Presse-étoupe: 4.1

3.2 EPIC® D A - V I N C I H - B

Tüllengehäuse / Hood / Capot

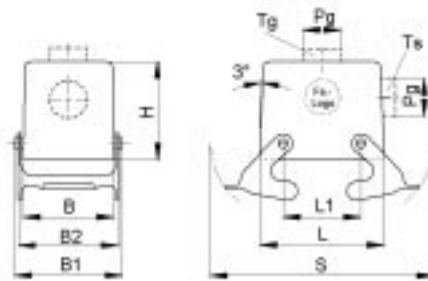

EPIC® H-B Gehäuse: Tüllengehäuse (Kabeleingang seitlich, Querbügel, hohe Bauform)
EPIC® H-B housings: hood (side entry, double locking lever, high version)
Boîtiers EPIC® H-B: capot (sortie latérale, double levier, version haute)

H-B 10

Artikel part article	Art.Nr. part No. N° art.	Art.Nr.: EP part No.: EP N° art.: EP	PG	L	L1	L2	L3	L4	B	B1	B2	B3	B4	B5	H	H1	H2	S	d
H-B 10 TSBH 21	70057200	70058200	21		73	27			43	57,8	53				72				116
H-B 10 TSBH 29	70057400	70058400	29																

Einsätze / Inserts / Inserts: 1.3: H-BE 10 / 1.5: H-BVE 3 / 1.7: H-DD 42 / 1.8: MC 10

Deckel / Cover / Couvercle: 5.1: H-B 10

Kabelverschraubung / Cable gland / Presse-étoupe: 4.1

H-B 16

Artikel part article	Art.Nr. part No. N° art.	Art.Nr.: EP part No.: EP N° art.: EP	PG	L	L1	L2	L3	L4	B	B1	B2	B3	B4	B5	H	H1	H2	S	d
H-B 16 TSBH 21	70107200	70108200	21		93,3	47,5			43	57,8	53				76				136,5
H-B 16 TSBH 29	70107400	70108400	29																

Einsätze / Inserts / Inserts: 1.3: H-BE 16 / 1.4: H-BS 6 / 1.5: H-BVE 6 / 1.6: H-D 40 / 1.7: H-DD 72 / 1.8: MC 16

Deckel / Cover / Couvercle: 5.1: H-B 16

Kabelverschraubung / Cable gland / Presse-étoupe: 4.1

H-B 24

Artikel part article	Art.Nr. part No. N° art.	Art.Nr.: EP part No.: EP N° art.: EP	PG	L	L1	L2	L3	L4	B	B1	B2	B3	B4	B5	H	H1	H2	S	d
H-B 24 TSBH 21	70157400	70158400	21		120	74			43	57,8	53				76				163
H-B 24 TSBH 29	70157600	70158600	29																

Einsätze / Inserts / Inserts: 1.3: H-BE 24 / 1.5: H-BVE 10 / 1.6: H-D 64 / 1.7: H-DD 108 / 1.8: MC 24

Deckel / Cover / Couvercle: 5.1: H-B 24

Kabelverschraubung / Cable gland / Presse-étoupe: 4.1

H-B 32

Artikel part article	Art.Nr. part No. N° art.	Art.Nr.: EP part No.: EP N° art.: EP	PG	L	L1	L2	L3	L4	B	B1	B2	B3	B4	B5	H	H1	H2	S	d
H-B 32 TSB 29	10136600	-	29	93,5	64,5				79	93,8	87,8				95				136,5

Einsätze / Inserts / Inserts: 1.3: H-BE 32 / 1.4: H-BS 12 / 1.6: H-D 80 / 1.7: H-DD 144 / 1.8: 2 x MC 16

Kabelverschraubung / Cable gland / Presse-étoupe: 4.1

3.2 EPIC® D A - V I N C I H - B

Anbaugehäuse / Panel mount base / Embase encastrée

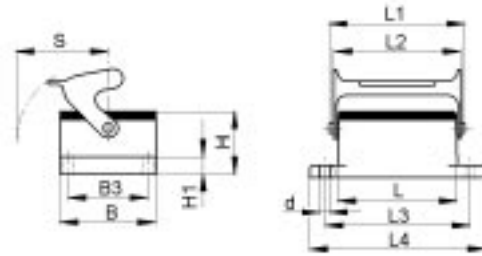

EPIC® H-B Gehäuse: Anbaugehäuse (Längsbügel)
EPIC® H-B housings: panel mount base (single locking lever)
Boîtiers EPIC® H-B: embase encastrée (simple levier)

H-B 6

Artikel part article	Art.Nr. part No. N° art.	Art.Nr.: EP part No.: EP N° art.: EP	PG	L	L1	L2	L3	L4	B	B1	B2	B3	B4	B5	H	H1	H2	S	d
H-B 6 AG	10003000*	70002500		60	74,8	70	70	80	43			32			27,8	4		44	4,3

Einsätze / Inserts / Inserts: 1.3: H-BE 6 / 1.7: H-DD 24 / 1.8: MC 6 / 1.9: TB-H-BE 6, TB-H-D 16
 Deckel / Cover / Couverture: 5.1: H-B 6

H-B 10

Artikel part article	Art.Nr. part No. N° art.	Art.Nr.: EP part No.: EP N° art.: EP	PG	L	L1	L2	L3	L4	B	B1	B2	B3	B4	B5	H	H1	H2	S	d
H-B 10 AG-LB	10032900*	70032700		73	91	88,5	83	93	43			32			27,8	4		50	4,3

Einsätze / Inserts / Inserts: 1.3: H-BE 10 / 1.5: H-BVE 3 / 1.7: H-DD 42 / 1.8: MC 10 / 1.9: TB-H-BE 10, TB-H-D 24

H-B 16

Artikel part article	Art.Nr. part No. N° art.	Art.Nr.: EP part No.: EP N° art.: EP	PG	L	L1	L2	L3	L4	B	B1	B2	B3	B4	B5	H	H1	H2	S	d
H-B 16 AG-LB	10072900*	70082700		93,3	111	109,5	103	113	43			32			27,8	4		50	4,3

Einsätze / Inserts / Inserts: 1.3: H-BE 16 / 1.4: H-BS 6 / 1.5: H-BVE 6 / 1.6: H-D 40 / 1.7: H-DD 72 / 1.8: MC 16 / 1.9: TB-H-BE 16, TB-H-D 40

H-B 24

Artikel part article	Art.Nr. part No. N° art.	Art.Nr.: EP part No.: EP N° art.: EP	PG	L	L1	L2	L3	L4	B	B1	B2	B3	B4	B5	H	H1	H2	S	d
H-B 24 AG-LB	10102900*	70132700		120	138	136,5	130	140	43			32			27,8	4		50	4,3

Einsätze / Inserts / Inserts: 1.3: H-BE 24 / 1.5: H-BVE 10 / 1.6: H-D 64 / 1.7: H-DD 108 / 1.8: MC 24 / 1.9: TB-H-BE 24, TB-H-D 64

H-B 48

Artikel part article	Art.Nr. part No. N° art.	Art.Nr.: EP part No.: EP N° art.: EP	PG	L	L1	L2	L3	L4	B	B1	B2	B3	B4	B5	H	H1	H2	S	d
H-B 48 AG-LB	10161000*	-		132	152	139,5	148	165	90			70			39,5	10		105	7

Einsätze / Inserts / Inserts: 1.3: H-BE 48 / 1.5: 2 x H-BVE 10 / 1.6: H-D 128 / 1.7: H-DD 216 / 1.8: 2 x MC 24 / 1.9: TB-H-BE 48

3.2 EPIC® D A - V I N C I H - B

Anbaugehäuse / Panel mount base / Embase encastrée

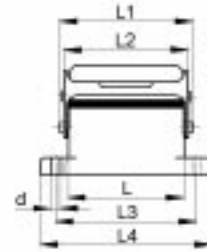
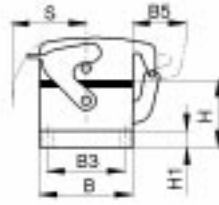

EPIC® H-B Gehäuse: Anbaugehäuse (Schutzdeckel, Längsbügel)
EPIC® H-B housings: panel mount base (cover, single locking lever)
Boîtiers EPIC® H-B: embase encastrée (couvercle, simple levier)

H-B 6

Artikel part article	Art.Nr. part No. N° art.	Art.Nr.: EP part No.: EP N° art.: EP	PG	L	L1	L2	L3	L4	B	B1	B2	B3	B4	B5	H	H1	H2	S	d
H-B 6 AD	10004000*	70004500		60	74,8	70	70	80	43			32		25	27,8	4		44	4,3

Einsätze / Inserts / Inserts: 1.3: H-BE 6 / 1.7: H-DD 24 / 1.8: MC 6 / 1.9: TB-H-BE 6, TB-H-D 16

H-B 10

Artikel part article	Art.Nr. part No. N° art.	Art.Nr.: EP part No.: EP N° art.: EP	PG	L	L1	L2	L3	L4	B	B1	B2	B3	B4	B5	H	H1	H2	S	d
H-B 10 AD-LB	10033900*	70033700		73	91	88,5	83	93	43			32		25	27,8	4		50	4,3

Einsätze / Inserts / Inserts: 1.3: H-BE 10 / 1.5: H-BVE 3 / 1.7: H-DD 42 / 1.8: MC 10 / 1.9: TB-H-BE 10, TB-H-D 24

H-B 16

Artikel part article	Art.Nr. part No. N° art.	Art.Nr.: EP part No.: EP N° art.: EP	PG	L	L1	L2	L3	L4	B	B1	B2	B3	B4	B5	H	H1	H2	S	d
H-B 16 AD-LB	10073900*	70083700		93,3	111	109,5	103	113	43			32		25	27,8	4		50	4,3

Einsätze / Inserts / Inserts: 1.3: H-BE 16 / 1.4: H-BS 6 / 1.5: H-BVE 6 / 1.6: H-D 40 / 1.7: H-DD 72 / 1.8: MC 16 / 1.9: TB-H-BE 16, TB-H-D 40

H-B 24

Artikel part article	Art.Nr. part No. N° art.	Art.Nr.: EP part No.: EP N° art.: EP	PG	L	L1	L2	L3	L4	B	B1	B2	B3	B4	B5	H	H1	H2	S	d
H-B 24 AD-LB	10103900*	70133700		120	138	136,5	130	140	43			32		25	27,8	4		50	4,3

Einsätze / Inserts / Inserts: 1.3: H-BE 24 / 1.5: H-BVE 10 / 1.6: H-D 64 / 1.7: H-DD 108 / 1.8: MC 24 / 1.9: TB-H-BE 24, TB-H-D 64

H-B 48

Artikel part article	Art.Nr. part No. N° art.	Art.Nr.: EP part No.: EP N° art.: EP	PG	L	L1	L2	L3	L4	B	B1	B2	B3	B4	B5	H	H1	H2	S	d
H-B 48 AD	10152000*	-		132	152	139,5	148	165	90			70		30	39,5	10		105	7

Einsätze / Inserts / Inserts: 1.3: H-BE 48 / 1.5: 2 x H-BVE 10 / 1.6: H-D 128 / 1.7: H-DD 216 / 1.8: 2 x MC 24 / 1.9: TB-H-BE 48

3.2 EPIC® D A - V I N C I H - B

Anbaugehäuse / Panel mount base / Embase encastrée

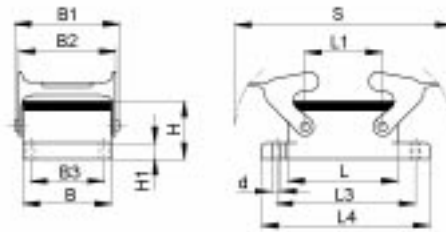

EPIC® H-B Gehäuse: Anbaugehäuse (Querbügel)
EPIC® H-B housings: panel mount base (double locking lever)
Boîtiers EPIC® H-B: embase encastrée (double levier)

H-B 10

Artikel part article	Art.Nr. part No. N° art.	Art.Nr.: EP part No: EP N° art.: EP	PG	L	L1	L2	L3	L4	B	B1	B2	B3	B4	B5	H	H1	H2	S	d
H-B 10 AG	10032000*	70032500		73	27		83	93	43	57,8	53	32			27,8	4		116	4,3

Einsätze / Inserts / Inserts: 1.3: H-BE 10 / 1.5: H-BVE 3 / 1.7: H-DD 42 / 1.8: MC 10 / 1.9: TB-H-BE 10, TB-H-D 24
 Deckel / Cover / Couvercle: 5.1: H-B 10

H-B 16

Artikel part article	Art.Nr. part No. N° art.	Art.Nr.: EP part No: EP N° art.: EP	PG	L	L1	L2	L3	L4	B	B1	B2	B3	B4	B5	H	H1	H2	S	d
H-B 16 AG	10072000*	70082500		93,3	47,5		103	113	43	57,8	53	32			27,8	4		136,5	4,3

Einsätze / Inserts / Inserts: 1.3: H-BE 16 / 1.4: H-BS 6 / 1.5: H-BVE 6 / 1.6: H-D 40 / 1.7: H-DD 72 / 1.8: MC 16 / 1.9: TB-H-BE 16, TB-H-D 40
 Deckel / Cover / Couvercle: 5.1: H-B 16

H-B 24

Artikel part article	Art.Nr. part No. N° art.	Art.Nr.: EP part No: EP N° art.: EP	PG	L	L1	L2	L3	L4	B	B1	B2	B3	B4	B5	H	H1	H2	S	d
H-B 24 AG	10102000*	70132500		120	74		130	140	43	57,8	53	32			27,8	4		163	4,3

Einsätze / Inserts / Inserts: 1.3: H-BE 24 / 1.5: H-BVE 10 / 1.6: H-D 64 / 1.7: H-DD 108 / 1.8: MC 24 / 1.9: TB-H-BE 24, TB-H-D 64
 Deckel / Cover / Couvercle: 5.1: H-B 24

H-B 32

Artikel part article	Art.Nr. part No. N° art.	Art.Nr.: EP part No: EP N° art.: EP	PG	L	L1	L2	L3	L4	B	B1	B2	B3	B4	B5	H	H1	H2	S	d
H-B 32 AG	10132000*	-		93,5	64,5		110	124	79	93,8	87,8	65			30,3	5		136,5	5,5

Einsätze / Inserts / Inserts: 1.3: H-BE 32 / 1.4: H-BS 12 / 1.6: H-D 80 / 1.7: H-DD 144 / 1.8: 2 x MC 24 / 1.9: TB-H-BE 32

3.2 EPIC® D A - V I N C I H - B

Anbaugehäuse / Panel mount base / Embase encastrée

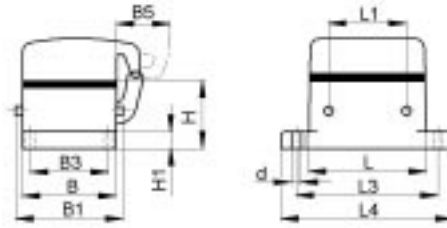

EPIC® H-B Gehäuse: Anbaugehäuse (Schutzdeckel, Bolzen für Querbügel)

EPIC® H-B housings: panel mount base (cover, bolts for double locking lever)

Boîtiers EPIC® H-B: embase encastrée (couvercle, ergots pour double levier)

H-B 10

Artikel part article	Art.Nr. part No. N° art.	Art.Nr.: EP part No.: EP N° art.: EP	PG	L	L1	L2	L3	L4	B	B1	B2	B3	B4	B5	H	H1	H2	S	d
H-B 10 AD-BO	10033000*	70033500		73	27		83	93	43	57,8		32		25	27,8	4			4,3

Einsätze / Inserts / Inserts: 1.3: H-BE 10 / 1.5: H-BVE 3 / 1.7: H-DD 42 / 1.8: MC 10 / 1.9: TB-H-BE 10, TB-H-D 24

H-B 16

Artikel part article	Art.Nr. part No. N° art.	Art.Nr.: EP part No.: EP N° art.: EP	PG	L	L1	L2	L3	L4	B	B1	B2	B3	B4	B5	H	H1	H2	S	d
H-B 16 AD-BO	10073000*	70083500		93,3	47,5		103	113	43	57,8		32		25	27,8	4			4,3

Einsätze / Inserts / Inserts: 1.3: H-BE 16 / 1.4: H-BS 6 / 1.5: H-BVE 6 / 1.6: H-D 40 / 1.7: H-DD 72 / 1.8: MC 16 / 1.9: TB-H-BE 16, TB-H-D 40

H-B 24

Artikel part article	Art.Nr. part No. N° art.	Art.Nr.: EP part No.: EP N° art.: EP	PG	L	L1	L2	L3	L4	B	B1	B2	B3	B4	B5	H	H1	H2	S	d
H-B 24 AD-BO	10103000*	70133500		120	74		130	140	43	57,8		32		25	27,8	4			4,3

Einsätze / Inserts / Inserts: 1.3: H-BE 24 / 1.5: H-BVE 10 / 1.6: H-D 64 / 1.7: H-DD 108 / 1.8: MC 24 / 1.9: TB-H-BE 24, TB-H-D 64

3.2 EPIC® D A - V I N C I H - B

Sockelgehäuse / *Surface mount base* / *Embase en saillie*

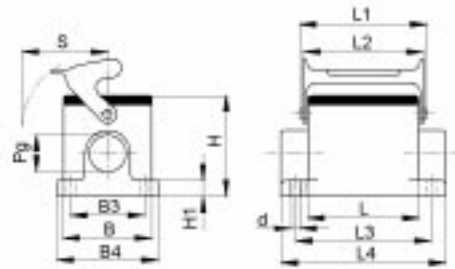

EPIC® H-B Gehäuse: Sockelgehäuse (2 Kabeleingänge, Längsbügel)

EPIC® H-B housings: surface mount base (2 cable entries, single locking lever)

Boîtiers EPIC® H-B: embase en saillie (2 entrées de câble, simple levier)

H-B 6

Artikel <i>part</i> <i>article</i>	Art.Nr. <i>part No.</i> <i>N° art.</i>	Art.Nr.: EP <i>part No: EP</i> <i>N° art.: EP</i>	PG	L	L1	L2	L3	L4	B	B1	B2	B3	B4	B5	H	H1	H2	S	d
H-B 6 SGRL 16	10006000*	70008000	16	60	74,8	70	70	84	43			40	54		54	4,5		44	5,5

Einsätze / *Inserts* / *Inserts*: 1.3: H-BE 6 / 1.7: H-DD 24 / 1.8: MC 6

Deckel / *Cover* / *Couvercle*: 5.1: H-B 6

Kabelverschraubung / *Cable gland* / *Presse-étoupe*: 4.1

H-B 10

Artikel <i>part</i> <i>article</i>	Art.Nr. <i>part No.</i> <i>N° art.</i>	Art.Nr.: EP <i>part No: EP</i> <i>N° art.: EP</i>	PG	L	L1	L2	L3	L4	B	B1	B2	B3	B4	B5	H	H1	H2	S	d
H-B 10 SGRL-LB 16	10035900	70063000	16	73	91	88,5	82	94	43			40	54		57	4,5		50	5,5

Einsätze / *Inserts* / *Inserts*: 1.3: H-BE 10 / 1.5: H-BVE 3 / 1.7: H-DD 42 / 1.8: MC 10

Kabelverschraubung / *Cable gland* / *Presse-étoupe*: 4.1

H-B 16

Artikel <i>part</i> <i>article</i>	Art.Nr. <i>part No.</i> <i>N° art.</i>	Art.Nr.: EP <i>part No: EP</i> <i>N° art.: EP</i>	PG	L	L1	L2	L3	L4	B	B1	B2	B3	B4	B5	H	H1	H2	S	d
H-B 16 SGRL-LB 21	10075900	70113000	21	93	111	109,5	105	117	43			45	57		64	4,5		50	5,5

Einsätze / *Inserts* / *Inserts*: 1.3: H-BE 16 / 1.4: H-BS 6 / 1.5: H-BVE 6 / 1.6: H-D 40 / 1.7: H-DD 72 / 1.8: MC 16

Kabelverschraubung / *Cable gland* / *Presse-étoupe*: 4.1

H-B 24

Artikel <i>part</i> <i>article</i>	Art.Nr. <i>part No.</i> <i>N° art.</i>	Art.Nr.: EP <i>part No: EP</i> <i>N° art.: EP</i>	PG	L	L1	L2	L3	L4	B	B1	B2	B3	B4	B5	H	H1	H2	S	d
H-B 24 SGRL-LB 21	10105900	70163000	21	120	138	136,5	132	144	43			45	57		64	4,5		50	5,5

Einsätze / *Inserts* / *Inserts*: 1.3: H-BE 24 / 1.5: H-BVE 10 / 1.6: H-D 64 / 1.7: H-DD 108 / 1.8: MC 24

Kabelverschraubung / *Cable gland* / *Presse-étoupe*: 4.1

H-B 48

Artikel <i>part</i> <i>article</i>	Art.Nr. <i>part No.</i> <i>N° art.</i>	Art.Nr.: EP <i>part No: EP</i> <i>N° art.: EP</i>	PG	L	L1	L2	L3	L4	B	B1	B2	B3	B4	B5	H	H1	H2	S	d
H-B 48 SGRL 29	10166000	-	29	132	152	139,5	111	132	90			106	120		100	12		105	6,5
H-B 48 SGRL 36	10166100	-	36																

Einsätze / *Inserts* / *Inserts*: 1.3: H-BE 48 / 1.5: 2 x H-BVE 10 / 1.6: H-D 128 / 1.7: H-DD 216 / 1.8: 2 x MC 24

Kabelverschraubung / *Cable gland* / *Presse-étoupe*: 4.1

3.2 EPIC® D A - V I N C I H - B

Sockelgehäuse / Surface mount base / Embase en saillie

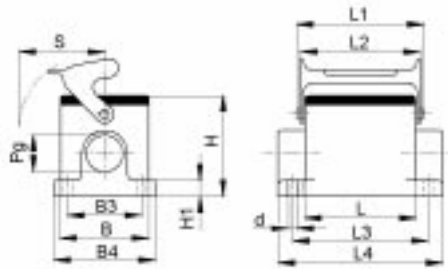

EPIC® H-B Gehäuse: Sockelgehäuse (2 Kabeleingänge, Längsbügel, hohe Bauform)

EPIC® H-B housings: surface mount base (2 cable entries, single locking lever, high version)

Boîtiers EPIC® H-B: embase en saillie (2 entrées de câble, simple levier, version haute)

H-B 6

Artikel part article	Art.Nr. part No. N° art.	Art.Nr.: EP part No.: EP N° art.: EP	PG	L	L1	L2	L3	L4	B	B1	B2	B3	B4	B5	H	H1	H2	S	d
H-B 6 SGR LH 21	70006200	70008200	21	60	74,8	70	70	84	43			45	58		74	6		44	5,5
H-B 6 SGR LH 29	70006400	70008400	29																

Einsätze / Inserts / Inserts: 1.3: H-BE 6 / 1.7: H-DD 24 / 1.8: MC 6

Deckel / Cover / Couvercle: 5.1: H-B 6

Kabelverschraubung / Cable gland / Presse-étoupe: 4.1

H-B 10

Artikel part article	Art.Nr. part No. N° art.	Art.Nr.: EP part No.: EP N° art.: EP	PG	L	L1	L2	L3	L4	B	B1	B2	B3	B4	B5	H	H1	H2	S	d
H-B 10 SGR LH-LB 21	70061200	70063200	21	73	91	88,5	82	97	43			45	58		74	6		50	5,5
H-B 10 SGR LH-LB 29	70061400	70063400	29																

Einsätze / Inserts / Inserts: 1.3: H-BE 10 / 1.5: H-BVE 3 / 1.7: H-DD 42 / 1.8: MC 10

Kabelverschraubung / Cable gland / Presse-étoupe: 4.1

H-B 16

Artikel part article	Art.Nr. part No. N° art.	Art.Nr.: EP part No.: EP N° art.: EP	PG	L	L1	L2	L3	L4	B	B1	B2	B3	B4	B5	H	H1	H2	S	d
H-B 16 SGR LH-LB 21	70111200	70113200	21	93,3	111	109,5	105	117	43			45	58		84	6		50	5,5
H-B 16 SGR LH-LB 29	70111400	70113400	29																

Einsätze / Inserts / Inserts: 1.3: H-BE 16 / 1.4: H-BS 6 / 1.5: H-BVE 6 / 1.6: H-D 40 / 1.7: H-DD 72 / 1.8: MC 16

Kabelverschraubung / Cable gland / Presse-étoupe: 4.1

H-B 24

Artikel part article	Art.Nr. part No. N° art.	Art.Nr.: EP part No.: EP N° art.: EP	PG	L	L1	L2	L3	L4	B	B1	B2	B3	B4	B5	H	H1	H2	S	d
H-B 24 SGR LH-LB 21	70161200	70163200	21	120	138	136,5	132	144	43			45	58		84	6		50	5,5
H-B 24 SGR LH-LB 29	70161400	70163400	29																

Einsätze / Inserts / Inserts: 1.3: H-BE 24 / 1.5: H-BVE 10 / 1.6: H-D 64 / 1.7: H-DD 108 / 1.8: MC 24

Kabelverschraubung / Cable gland / Presse-étoupe: 4.1

3.2 EPIC® D A - V I N C I H - B

Sockelgehäuse / *Surface mount base* / *Embase en saillie*

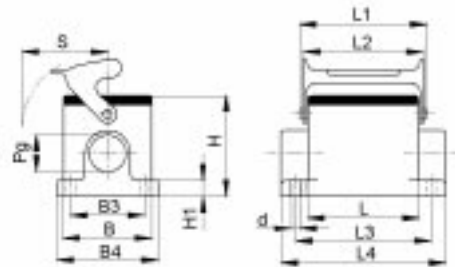

EPIC® H-B Gehäuse: Sockelgehäuse (1 Kabeleingang, Längsbügel)
EPIC® H-B housings: surface mount base (1 cable entry, single locking lever)
Boîtiers EPIC® H-B: embase en saillie (1 entrée de câble, simple levier)

H-B 6

Artikel <i>part</i> <i>article</i>	Art.Nr. <i>part No.</i> <i>N° art.</i>	Art.Nr.: EP <i>part No: EP</i> <i>N° art.: EP</i>	PG	L	L1	L2	L3	L4	B	B1	B2	B3	B4	B5	H	H1	H2	S	d
H-B 6 SGR 16	10005000*	70007000	16	60	74,8	70	70	84	43				40	54	54	4,5		44	5,5

Einsätze / *Inserts* / *Inserts*: 1.3: H-BE 6 / 1.7: H-DD 24 / 1.8: MC 6
 Deckel / *Cover* / *Couvercle*: 5.1: H-B 6
 Kabelverschraubung / *Cable gland* / *Presse-étoupe*: 4.1

H-B 10

Artikel <i>part</i> <i>article</i>	Art.Nr. <i>part No.</i> <i>N° art.</i>	Art.Nr.: EP <i>part No: EP</i> <i>N° art.: EP</i>	PG	L	L1	L2	L3	L4	B	B1	B2	B3	B4	B5	H	H1	H2	S	d
H-B 10 SGR-LB 16	10034900*	70062000	16	73	91	88,5	82	94	43				40	54	57	4,5		50	5,5
H-B 10 SGR-LB 21	10034100*	-	21																

Einsätze / *Inserts* / *Inserts*: 1.3: H-BE 10 / 1.5: H-BVE 3 / 1.7: H-DD 42 / 1.8: MC 10
 Kabelverschraubung / *Cable gland* / *Presse-étoupe*: 4.1

H-B 16

Artikel <i>part</i> <i>article</i>	Art.Nr. <i>part No.</i> <i>N° art.</i>	Art.Nr.: EP <i>part No: EP</i> <i>N° art.: EP</i>	PG	L	L1	L2	L3	L4	B	B1	B2	B3	B4	B5	H	H1	H2	S	d
H-B 16 SGR-LB 21	10074900*	70112000	21	93	111	109,5	105	117	43				45	57	64	4,5		50	5,5

Einsätze / *Inserts* / *Inserts*: 1.3: H-BE 16 / 1.4: H-BS 6 / 1.5: H-BVE 6 / 1.6: H-D 40 / 1.7: H-DD 72 / 1.8: MC 16
 Kabelverschraubung / *Cable gland* / *Presse-étoupe*: 4.1

H-B 24

Artikel <i>part</i> <i>article</i>	Art.Nr. <i>part No.</i> <i>N° art.</i>	Art.Nr.: EP <i>part No: EP</i> <i>N° art.: EP</i>	PG	L	L1	L2	L3	L4	B	B1	B2	B3	B4	B5	H	H1	H2	S	d
H-B 24 SGR-LB 21	10104900	70162000	21	120	138	136,5	132	144	43				45	57	64	4,5		50	5,5

Einsätze / *Inserts* / *Inserts*: 1.3: H-BE 24 / 1.5: H-BVE 10 / 1.6: H-D 64 / 1.7: H-DD 108 / 1.8: MC 24
 Kabelverschraubung / *Cable gland* / *Presse-étoupe*: 4.1

H-B 48

Artikel <i>part</i> <i>article</i>	Art.Nr. <i>part No.</i> <i>N° art.</i>	Art.Nr.: EP <i>part No: EP</i> <i>N° art.: EP</i>	PG	L	L1	L2	L3	L4	B	B1	B2	B3	B4	B5	H	H1	H2	S	d
H-B 48 SGR 29	10165000	-	29	132	152	139,5	111	132	90				106	120	100	12		105	6,5
H-B 48 SGR 36	10165100	-	36																

Einsätze / *Inserts* / *Inserts*: 1.3: H-BE 48 / 1.5: 2 x H-BVE 10 / 1.6: H-D 128 / 1.7: H-DD 216 / 1.8: 2 x MC 24
 Kabelverschraubung / *Cable gland* / *Presse-étoupe*: 4.1

3.2 EPIC® D A - V I N C I H - B

Sockelgehäuse / Surface mount base / Embase en saillie

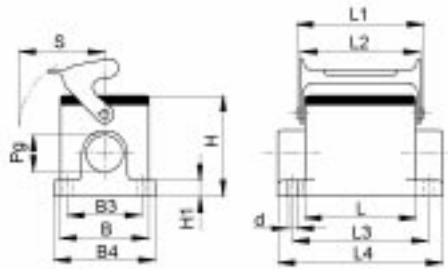

EPIC® H-B Gehäuse: Sockelgehäuse (1 Kabeleingang, Längsbügel, hohe Bauform)

EPIC® H-B housings: surface mount base (1 cable entry, single locking lever, high version)

Boîtiers EPIC® H-B: embase en saillie (1 entrée de câble, simple levier, version haute)

H-B 6

Artikel part article	Art.Nr. part No. N° art.	Art.Nr.: EP part No: EP N° art.: EP	PG	L	L1	L2	L3	L4	B	B1	B2	B3	B4	B5	H	H1	H2	S	d
H-B 6 SGRH 21	70005200	70007200	21	60	74,8	70	70	84	43			45	58		74	6		44	5,5
H-B 6 SGRH 29	70005400	70007400	29																

Einsätze / Inserts / Inserts: 1.3: H-BE 6 / 1.7: H-DD 24 / 1.8: MC 6

Deckel / Cover / Couvercle: 5.1: H-B 6

Kabelverschraubung / Cable gland / Presse-étoupe: 4.1

H-B 10

Artikel part article	Art.Nr. part No. N° art.	Art.Nr.: EP part No: EP N° art.: EP	PG	L	L1	L2	L3	L4	B	B1	B2	B3	B4	B5	H	H1	H2	S	d
H-B 10 SGRH-LB 21	70060200	70062200	21	73	91	88,5	82	97	43			45	58		74	6		50	5,5
H-B 10 SGRH-LB 29	70060400	70062400	29																

Einsätze / Inserts / Inserts: 1.3: H-BE 10 / 1.5: H-BVE 3 / 1.7: H-DD 42 / 1.8: MC 10

Kabelverschraubung / Cable gland / Presse-étoupe: 4.1

H-B 16

Artikel part article	Art.Nr. part No. N° art.	Art.Nr.: EP part No: EP N° art.: EP	PG	L	L1	L2	L3	L4	B	B1	B2	B3	B4	B5	H	H1	H2	S	d
H-B 16 SGRH-LB 21	70110200	70112200	21	93,3	111	109,5	105	117	43			45	58		84	6		50	5,5
H-B 16 SGRH-LB 29	70110400	70112400	29																

Einsätze / Inserts / Inserts: 1.3: H-BE 16 / 1.4: H-BS 6 / 1.5: H-BVE 6 / 1.6: H-D 40 / 1.7: H-DD 72 / 1.8: MC 16

Kabelverschraubung / Cable gland / Presse-étoupe: 4.1

H-B 24

Artikel part article	Art.Nr. part No. N° art.	Art.Nr.: EP part No: EP N° art.: EP	PG	L	L1	L2	L3	L4	B	B1	B2	B3	B4	B5	H	H1	H2	S	d
H-B 24 SGRH-LB 21	70160200	70162200	21	120	138	136,5	132	144	43			45	58		84	6		50	5,5
H-B 24SGRH-LB 29	70160400	70162400	29																

Einsätze / Inserts / Inserts: 1.3: H-BE 24 / 1.5: H-BVE 10 / 1.6: H-D 64 / 1.7: H-DD 108 / 1.8: MC 24

Kabelverschraubung / Cable gland / Presse-étoupe: 4.1

3.2 EPIC® D A - V I N C I H - B

Sockelgehäuse / *Surface mount base* / *Embase en saillie*

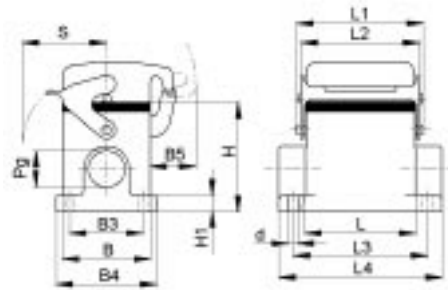

EPIC® H-B Gehäuse: Sockelgehäuse (Schutzdeckel, 2 Kabeleingänge, Längsbügel)
EPIC® H-B housings: surface mount base (cover, 2 cable entries, single locking lever)
Boîtiers EPIC® H-B: embase en saillie (couverture, 2 entrées de câble, simple levier)

H-B 6

Artikel part article	Art.Nr. part No. N° art.	Art.Nr.: EP part No.: EP N° art.: EP	PG	L	L1	L2	L3	L4	B	B1	B2	B3	B4	B5	H	H1	H2	S	d
H-B 6 SDRL 16	10009000*	70018000	16	60	74,8	70	70	84	43				40	54	25	54	4,5	44	5,5

Einsätze / *Inserts* / *Inserts*: 1.3: H-BE 6 / 1.7: H-DD 24 / 1.8: MC 6
 Kabelverschraubung / *Cable gland* / *Presse-étoupe*: 4.1

H-B 10

Artikel part article	Art.Nr. part No. N° art.	Art.Nr.: EP part No.: EP N° art.: EP	PG	L	L1	L2	L3	L4	B	B1	B2	B3	B4	B5	H	H1	H2	S	d
H-B 10 SDRL-LB 16	10038900*	70067000	16	73	91	88,5	82	94	43				40	54	25	57	4,5	50	5,5

Einsätze / *Inserts* / *Inserts*: 1.3: H-BE 10 / 1.5: H-BVE 3 / 1.7: H-DD 42 / 1.8: MC 10
 Kabelverschraubung / *Cable gland* / *Presse-étoupe*: 4.1

H-B 16

Artikel part article	Art.Nr. part No. N° art.	Art.Nr.: EP part No.: EP N° art.: EP	PG	L	L1	L2	L3	L4	B	B1	B2	B3	B4	B5	H	H1	H2	S	d
H-B 16 SDRL-LB 21	10078900*	70117000	21	93	111	109,5	105	117	43				45	57	25	64	4,5	50	5,5

Einsätze / *Inserts* / *Inserts*: 1.3: H-BE 16 / 1.4: H-BS 6 / 1.5: H-BVE 6 / 1.6: H-D 40 / 1.7: H-DD 72 / 1.8: MC 16
 Kabelverschraubung / *Cable gland* / *Presse-étoupe*: 4.1

H-B 24

Artikel part article	Art.Nr. part No. N° art.	Art.Nr.: EP part No.: EP N° art.: EP	PG	L	L1	L2	L3	L4	B	B1	B2	B3	B4	B5	H	H1	H2	S	d
H-B 24 SDRL-LB 21	10109900*	70167000	21	120	138	136,5	132	144	43				45	57	25	64	4,5	50	5,5

Einsätze / *Inserts* / *Inserts*: 1.3: H-BE 24 / 1.5: H-BVE 10 / 1.6: H-D 64 / 1.7: H-DD 108 / 1.8: MC 24
 Kabelverschraubung / *Cable gland* / *Presse-étoupe*: 4.1

H-B 48

Artikel part article	Art.Nr. part No. N° art.	Art.Nr.: EP part No.: EP N° art.: EP	PG	L	L1	L2	L3	L4	B	B1	B2	B3	B4	B5	H	H1	H2	S	d	
H-B 48 SDRL 29	10168000	-	29	132	152	139,5	111	132	90				106	120	30	100	12	105	6,5	
H-B 48 SDRL 36	10168100	-	36																	

Einsätze / *Inserts* / *Inserts*: 1.3: H-BE 48 / 1.5: 2 x H-BVE 10 / 1.6: H-D 128 / 1.7: H-DD 216 / 1.8: 2 x MC 24
 Kabelverschraubung / *Cable gland* / *Presse-étoupe*: 4.1

3.2 EPIC® D A - V I N C I H - B

Sockelgehäuse / Surface mount base / Embase en saillie

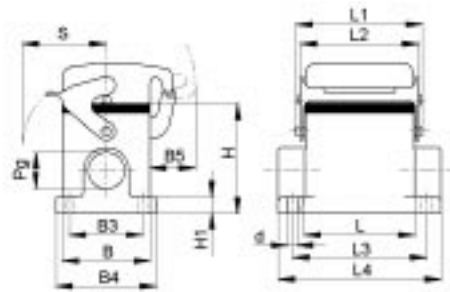

EPIC® H-B Gehäuse: Sockelgehäuse (Schutzdeckel, 2 Kabeleingänge, Längsbügel, hohe Bauform)
EPIC® H-B housings: surface mount base (cover, 2 cable entries, single locking lever, high version)
Boîtiers EPIC® H-B: embase en saillie (couverture, 2 entrées de câble, simple levier, version haute)

H-B 6

Artikel part article	Art.Nr. part No. N° art.	Art.Nr.: EP part No: EP N° art.: EP	PG	L	L1	L2	L3	L4	B	B1	B2	B3	B4	B5	H	H1	H2	S	d
H-B 6 SDR LH 21	70016200	70018200	21	60	74,8	70	70	84	43			45	58	25	74	6		44	5,5
H-B 6 SDR LH 29	70016400	70018400	29																

Einsätze / Inserts / Inserts: 1.3: H-BE 6 / 1.7: H-DD 24 / 1.8: MC 6
 Kabelverschraubung / Cable gland / Presse-étoupe: 4.1

H-B 10

Artikel part article	Art.Nr. part No. N° art.	Art.Nr.: EP part No: EP N° art.: EP	PG	L	L1	L2	L3	L4	B	B1	B2	B3	B4	B5	H	H1	H2	S	d
H-B 10 SDR LH-LB 21	70065200	70067200	21	73	91	88,5	82	97	43			45	58	25	74	6		50	5,5
H-B 10 SDR LH-LB 29	70065400	70067400	29																

Einsätze / Inserts / Inserts: 1.3: H-BE 10 / 1.5: H-BVE 3 / 1.7: H-DD 42 / 1.8: MC 10
 Kabelverschraubung / Cable gland / Presse-étoupe: 4.1

H-B 16

Artikel part article	Art.Nr. part No. N° art.	Art.Nr.: EP part No: EP N° art.: EP	PG	L	L1	L2	L3	L4	B	B1	B2	B3	B4	B5	H	H1	H2	S	d
H-B 16 SDR LH-LB 21	70115200	70117200	21	93,3	111	109,5	105	117	43			45	58	25	84	6		50	5,5
H-B 16 SDR LH-LB 29	70115400	70117400	29																

Einsätze / Inserts / Inserts: 1.3: H-BE 16 / 1.4: H-BS 6 / 1.5: H-BVE 6 / 1.6: H-D 40 / 1.7: H-DD 72 / 1.8: MC 16
 Kabelverschraubung / Cable gland / Presse-étoupe: 4.1

H-B 24

Artikel part article	Art.Nr. part No. N° art.	Art.Nr.: EP part No: EP N° art.: EP	PG	L	L1	L2	L3	L4	B	B1	B2	B3	B4	B5	H	H1	H2	S	d
H-B 24 SDR LH-LB 21	70165200	70167200	21	120	138	136,5	132	144	43			45	58	25	84	6		50	5,5
H-B 24 SDR LH-LB 29	70165400	70167400	29																

Einsätze / Inserts / Inserts: 1.3: H-BE 24 / 1.5: H-BVE 10 / 1.6: H-D 64 / 1.7: H-DD 108 / 1.8: MC 24
 Kabelverschraubung / Cable gland / Presse-étoupe: 4.1

3.2 EPIC® D A - V I N C I H - B

Sockelgehäuse / *Surface mount base* / *Embase en saillie*

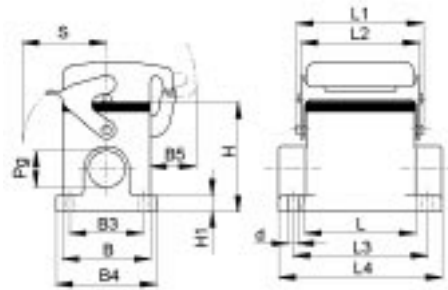

EPIC® H-B Gehäuse: Sockelgehäuse (Schutzdeckel, 1 Kabeleingang, Längsbügel)
EPIC® H-B housings: surface mount base (cover, 1 cable entry, single locking lever)
Boîtiers EPIC® H-B: embase en saillie (couverture, 1 entrée de câble, simple levier)

H-B 6

Artikel <i>part</i> <i>article</i>	Art.Nr. <i>part No.</i> <i>N° art.</i>	Art.Nr.: EP <i>part No.: EP</i> <i>N° art.: EP</i>	PG	L	L1	L2	L3	L4	B	B1	B2	B3	B4	B5	H	H1	H2	S	d	
H-B 6 SDR 16	10007000*	70017000	16	60	74,8	70	70	84	43				40	54	25	54	4,5		44	5,5

Einsätze / *Inserts* / *Inserts*: 1.3: H-BE 6 / 1.7: H-DD 24 / 1.8: MC 6
 Kabelverschraubung / *Cable gland* / *Presse-étoupe*: 4.1

H-B 10

Artikel <i>part</i> <i>article</i>	Art.Nr. <i>part No.</i> <i>N° art.</i>	Art.Nr.: EP <i>part No.: EP</i> <i>N° art.: EP</i>	PG	L	L1	L2	L3	L4	B	B1	B2	B3	B4	B5	H	H1	H2	S	d	
H-B 10 SDR-LB 16	10036900*	70066000	16	73	91	88,5	82	94	43				40	54	25	57	4,5		50	5,5

Einsätze / *Inserts* / *Inserts*: 1.3: H-BE 10 / 1.5: H-BVE 3 / 1.7: H-DD 42 / 1.8: MC 10
 Kabelverschraubung / *Cable gland* / *Presse-étoupe*: 4.1

H-B 16

Artikel <i>part</i> <i>article</i>	Art.Nr. <i>part No.</i> <i>N° art.</i>	Art.Nr.: EP <i>part No.: EP</i> <i>N° art.: EP</i>	PG	L	L1	L2	L3	L4	B	B1	B2	B3	B4	B5	H	H1	H2	S	d	
H-B 16 SDR-LB 21	10076900*	70116000	21	93	111	109,5	105	117	43				45	57	25	64	4,5		50	5,5

Einsätze / *Inserts* / *Inserts*: 1.3: H-BE 16 / 1.4: H-BS 6 / 1.5: H-BVE 6 / 1.6: H-D 40 / 1.7: H-DD 72 / 1.8: MC 16
 Kabelverschraubung / *Cable gland* / *Presse-étoupe*: 4.1

H-B 24

Artikel <i>part</i> <i>article</i>	Art.Nr. <i>part No.</i> <i>N° art.</i>	Art.Nr.: EP <i>part No.: EP</i> <i>N° art.: EP</i>	PG	L	L1	L2	L3	L4	B	B1	B2	B3	B4	B5	H	H1	H2	S	d	
H-B 24 SDR-LB 21	10107900*	70166000	21	120	138	136,5	132	144	43				45	57	25	64	4,5		50	5,5

Einsätze / *Inserts* / *Inserts*: 1.3: H-BE 24 / 1.5: H-BVE 10 / 1.6: H-D 64 / 1.7: H-DD 108 / 1.8: MC 24
 Kabelverschraubung / *Cable gland* / *Presse-étoupe*: 4.1

H-B 48

Artikel <i>part</i> <i>article</i>	Art.Nr. <i>part No.</i> <i>N° art.</i>	Art.Nr.: EP <i>part No.: EP</i> <i>N° art.: EP</i>	PG	L	L1	L2	L3	L4	B	B1	B2	B3	B4	B5	H	H1	H2	S	d	
H-B 48 SDR 29	10167000	-	29	132	152	139,5	111	132	90				106	120	30	100	12		105	6,5
H-B 48 SDR 36	10167100	-	36																	

Einsätze / *Inserts* / *Inserts*: 1.3: H-BE 48 / 1.5: 2 x H-BVE 10 / 1.6: H-D 128 / 1.7: H-DD 216 / 1.8: 2 x MC 24
 Kabelverschraubung / *Cable gland* / *Presse-étoupe*: 4.1

3.2 EPIC® D A - V I N C I H - B

Sockelgehäuse / Surface mount base / Embase en saillie

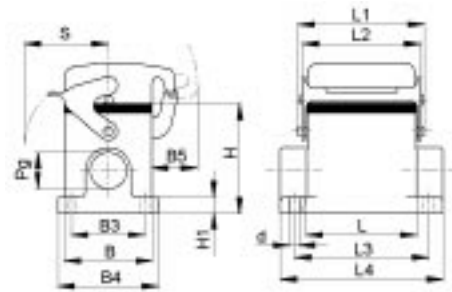

EPIC® H-B Gehäuse: Sockelgehäuse (Schutzdeckel, 1 Kabeleingang, Längsbügel, hohe Bauform)

EPIC® H-B housings: surface mount base (cover, 1 cable entry, single locking lever, high version)

Boîtiers EPIC® H-B: embase en saillie (couverture, 1 entrée de câble, simple levier, version haute)

H-B 6

Artikel part article	Art.Nr. part No. N° art.	Art.Nr.: EP part No: EP N° art.: EP	PG	L	L1	L2	L3	L4	B	B1	B2	B3	B4	B5	H	H1	H2	S	d
H-B 6 SDRH 21	70015200	70017200	21	60	74,8	70	70	84	43			45	58	25	74	6		44	5,5
H-B 6 SDRH 29	70015400	70017400	29																

Einsätze / Inserts / Inserts: 1.3: H-BE 6 / 1.7: H-DD 24 / 1.8: MC 6

Kabelverschraubung / Cable gland / Presse-étoupe: 4.1

H-B 10

Artikel part article	Art.Nr. part No. N° art.	Art.Nr.: EP part No: EP N° art.: EP	PG	L	L1	L2	L3	L4	B	B1	B2	B3	B4	B5	H	H1	H2	S	d
H-B 10 SDRH-LB 21	70064200	70066200	21	73	91	88,5	82	97	43			45	58	25	74	6		50	5,5
H-B 10 SDRH-LB 29	70064400	70066400	29																

Einsätze / Inserts / Inserts: 1.3: H-BE 10 / 1.5: H-BVE 3 / 1.7: H-DD 42 / 1.8: MC 10

Kabelverschraubung / Cable gland / Presse-étoupe: 4.1

H-B 16

Artikel part article	Art.Nr. part No. N° art.	Art.Nr.: EP part No: EP N° art.: EP	PG	L	L1	L2	L3	L4	B	B1	B2	B3	B4	B5	H	H1	H2	S	d
H-B 16 SDRH-LB 21	70114200	70116200	21	93,3	111	109,5	105	117	43			45	58	25	84	6		50	5,5
H-B 16 SDRH-LB 29	70114400	70116400	29																

Einsätze / Inserts / Inserts: 1.3: H-BE 16 / 1.4: H-BS 6 / 1.5: H-BVE 6 / 1.6: H-D 40 / 1.7: H-DD 72 / 1.8: MC 16

Kabelverschraubung / Cable gland / Presse-étoupe: 4.1

H-B 24

Artikel part article	Art.Nr. part No. N° art.	Art.Nr.: EP part No: EP N° art.: EP	PG	L	L1	L2	L3	L4	B	B1	B2	B3	B4	B5	H	H1	H2	S	d
H-B 24 SDRH-LB 21	70164200	70166200	21	120	138	136,5	132	144	43			45	58	25	84	6		50	5,5
H-B 24 SDRH-LB 29	70164400	70166400	29																

Einsätze / Inserts / Inserts: 1.3: H-BE 24 / 1.5: H-BVE 10 / 1.6: H-D 64 / 1.7: H-DD 108 / 1.8: MC 24

Kabelverschraubung / Cable gland / Presse-étoupe: 4.1

3.2 EPIC® D A - V I N C I H - B

Sockelgehäuse / *Surface mount base* / *Embase en saillie*

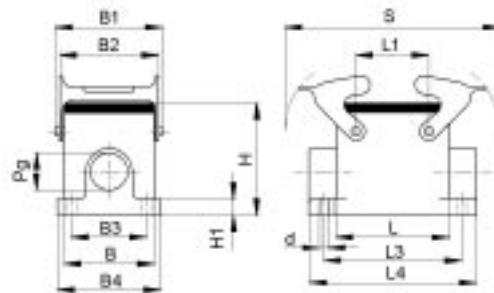

EPIC® H-B Gehäuse: Sockelgehäuse (2 Kabeleingänge, Querbügel)

EPIC® H-B housings: surface mount base (2 cable entries, double locking lever)

Boîtiers EPIC® H-B: embase en saillie (2 entrées de câble, double levier)

H-B 10

Artikel <i>part</i> <i>article</i>	Art.Nr. <i>part No.</i> <i>N° art.</i>	Art.Nr.: EP <i>part No: EP</i> <i>N° art.: EP</i>	PG	L	L1	L2	L3	L4	B	B1	B2	B3	B4	B5	H	H1	H2	S	d
H-B 10 SGRL 16	10035000*	70038000	16	73	27		82	94	43	57,8	53	40	54		57	4,5		116	5,5

Einsätze / *Inserts* / *Inserts*: 1.3: H-BE 10 / 1.5: H-BVE 3 / 1.7: H-DD 42 / 1.8: MC 10

Deckel / *Cover* / *Couvercle*: 5.1: H-B 10

Kabelverschraubung / *Cable gland* / *Presse-étoupe*: 4.1

H-B 16

Artikel <i>part</i> <i>article</i>	Art.Nr. <i>part No.</i> <i>N° art.</i>	Art.Nr.: EP <i>part No: EP</i> <i>N° art.: EP</i>	PG	L	L1	L2	L3	L4	B	B1	B2	B3	B4	B5	H	H1	H2	S	d
H-B 16 SGRL 21	10075000*	70088000	21	93	47,5		105	117	43	57,8	53	45	57		64	4,5		136,5	5,5

Einsätze / *Inserts* / *Inserts*: 1.3: H-BE 16 / 1.4: H-BS 6 / 1.5: H-BVE 6 / 1.6: H-D 40 / 1.7: H-DD 72 / 1.8: MC 16

Deckel / *Cover* / *Couvercle*: 5.1: H-B 16

Kabelverschraubung / *Cable gland* / *Presse-étoupe*: 4.1

H-B 24

Artikel <i>part</i> <i>article</i>	Art.Nr. <i>part No.</i> <i>N° art.</i>	Art.Nr.: EP <i>part No: EP</i> <i>N° art.: EP</i>	PG	L	L1	L2	L3	L4	B	B1	B2	B3	B4	B5	H	H1	H2	S	d
H-B 24 SGRL 21	10105000*	70138000	21	120	74		132	144	43	57,8	53	45	57		64	4,5		163	5,5

Einsätze / *Inserts* / *Inserts*: 1.3: H-BE 24 / 1.5: H-BVE 10 / 1.6: H-D 64 / 1.7: H-DD 108 / 1.8: MC 24

Kabelverschraubung / *Cable gland* / *Presse-étoupe*: 4.1

H-B 32

Artikel <i>part</i> <i>article</i>	Art.Nr. <i>part No.</i> <i>N° art.</i>	Art.Nr.: EP <i>part No: EP</i> <i>N° art.: EP</i>	PG	L	L1	L2	L3	L4	B	B1	B2	B3	B4	B5	H	H1	H2	S	d
H-B 32 SGRL 29	10138000	-	29	93,5	64,5		112	124,5	79	93,8	87,8	67	81		72	5		136,5	5,5

Einsätze / *Inserts* / *Inserts*: 1.3: H-BE 32 / 1.4: H-BS 12 / 1.6: H-D 80 / 1.7: H-DD 144 / 1.8: 2 x MC 16

Kabelverschraubung / *Cable gland* / *Presse-étoupe*: 4.1

3.2 EPIC® D A - V I N C I H - B

Sockelgehäuse / Surface mount base / Embase en saillie

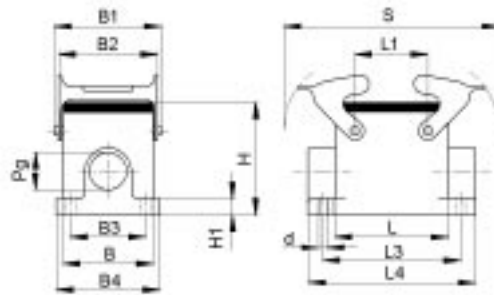

EPIC® H-B Gehäuse: Sockelgehäuse (2 Kabeleingänge, Querbügel, hohe Bauform)

EPIC® H-B housings: surface mount base (2 cable entries, double locking lever, high version)

Boîtiers EPIC® H-B: embase en saillie (2 entrées de câble, double levier, version haute)

H-B 10

Artikel part article	Art.Nr. part No. N° art.	Art.Nr.: EP part No.: EP N° art.: EP	PG	L	L1	L2	L3	L4	B	B1	B2	B3	B4	B5	H	H1	H2	S	d	
H-B 10 SGR LH 21	70036200	70038200	21		73	27		82	97	43	57,8	53	45	58		74	6		116	5,5
H-B 10 SGR LH 29	70036400	70038400	29																	

Einsätze / Inserts / Inserts: 1.3: H-BE 10 / 1.5: H-BVE 3 / 1.7: H-DD 42 / 1.8: MC 10

Deckel / Cover / Couvercle: 5.1: H-B 10

Kabelverschraubung / Cable gland / Presse-étoupe: 4.1

H-B 16

Artikel part article	Art.Nr. part No. N° art.	Art.Nr.: EP part No.: EP N° art.: EP	PG	L	L1	L2	L3	L4	B	B1	B2	B3	B4	B5	H	H1	H2	S	d	
H-B 16 SGR LH 21	70086200	70088200	21		93,3	47,5		105	117	43	57,8	53	45	58		84	6		136,5	5,5
H-B 16 SGR LH 29	70086400	70088400	29																	

Einsätze / Inserts / Inserts: 1.3: H-BE 16 / 1.4: H-BS 6 / 1.5: H-BVE 6 / 1.6: H-D 40 / 1.7: H-DD 72 / 1.8: MC 16

Deckel / Cover / Couvercle: 5.1: H-B 16

Kabelverschraubung / Cable gland / Presse-étoupe: 4.1

H-B 24

Artikel part article	Art.Nr. part No. N° art.	Art.Nr.: EP part No.: EP N° art.: EP	PG	L	L1	L2	L3	L4	B	B1	B2	B3	B4	B5	H	H1	H2	S	d	
H-B 24 SGR LH 21	70136200	70138200	21		120	74		132	144	43	57,8	53	45	58		84	6		163	5,5
H-B 24 SGR LH 29	70136400	70138400	29																	

Einsätze / Inserts / Inserts: 1.3: H-BE 24 / 1.5: H-BVE 10 / 1.6: H-D 64 / 1.7: H-DD 108 / 1.8: MC 24

Deckel / Cover / Couvercle: 5.1: H-B 24

Kabelverschraubung / Cable gland / Presse-étoupe: 4.1

3.2 EPIC® D A - V I N C I H - B

Sockelgehäuse / *Surface mount base* / *Embase en saillie*

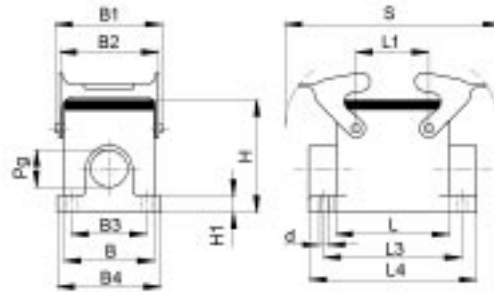

EPIC® H-B Gehäuse: Sockelgehäuse (1 Kabeleingang, Querbügel)

EPIC® H-B housings: surface mount base (1 cable entry, double locking lever)

Boîtiers EPIC® H-B: embase en saillie (1 entrée de câble, double levier)

H-B 10

Artikel <i>part</i> <i>article</i>	Art.Nr. <i>part No.</i> <i>N° art.</i>	Art.Nr.: EP <i>part No: EP</i> <i>N° art.: EP</i>	PG	L	L1	L2	L3	L4	B	B1	B2	B3	B4	B5	H	H1	H2	S	d
H-B 10 SGR 16	10034000*	70037000	16	73	27		82	94	43	57,8	53	40	54		57	4,5		116	5,5

Einsätze / *Inserts* / *Inserts*: 1.3: H-BE 10 / 1.5: H-BVE 3 / 1.7: H-DD 42 / 1.8: MC 10

Deckel / *Cover* / *Couvercle*: 5.1: H-B 10

Kabelverschraubung / *Cable gland* / *Presse-étoupe*: 4.1

H-B 16

Artikel <i>part</i> <i>article</i>	Art.Nr. <i>part No.</i> <i>N° art.</i>	Art.Nr.: EP <i>part No: EP</i> <i>N° art.: EP</i>	PG	L	L1	L2	L3	L4	B	B1	B2	B3	B4	B5	H	H1	H2	S	d
H-B 16 SGR 21	10074000*	70087000	21	93	47,5		105	117	43	57,8	53	45	57		64	4,5		136,5	5,5

Einsätze / *Inserts* / *Inserts*: 1.3: H-BE 16 / 1.4: H-BS 6 / 1.5: H-BVE 6 / 1.6: H-D 40 / 1.7: H-DD 72 / 1.8: MC 16

Deckel / *Cover* / *Couvercle*: 5.1: H-B 16

Kabelverschraubung / *Cable gland* / *Presse-étoupe*: 4.1

H-B 24

Artikel <i>part</i> <i>article</i>	Art.Nr. <i>part No.</i> <i>N° art.</i>	Art.Nr.: EP <i>part No: EP</i> <i>N° art.: EP</i>	PG	L	L1	L2	L3	L4	B	B1	B2	B3	B4	B5	H	H1	H2	S	d
H-B 24 SGR 21	10104000*	70137000	21	120	74		132	144	43	57,8	53	45	57		64	4,5		163	5,5

Einsätze / *Inserts* / *Inserts*: 1.3: H-BE 24 / 1.5: H-BVE 10 / 1.6: H-D 64 / 1.7: H-DD 108 / 1.8: MC 24

Deckel / *Cover* / *Couvercle*: 5.1: H-B 24

Kabelverschraubung / *Cable gland* / *Presse-étoupe*: 4.1

H-B 32

Artikel <i>part</i> <i>article</i>	Art.Nr. <i>part No.</i> <i>N° art.</i>	Art.Nr.: EP <i>part No: EP</i> <i>N° art.: EP</i>	PG	L	L1	L2	L3	L4	B	B1	B2	B3	B4	B5	H	H1	H2	S	d
H-B 32 SGR 29	10137000*	-	29	93,5	64,5		112	124,5	79	93,8	87,8	67	81		72	5		136,5	5,5

Einsätze / *Inserts* / *Inserts*: 1.3: H-BE 32 / 1.4: H-BS 12 / 1.6: H-D 80 / 1.7: H-DD 144 / 1.8: 2 x MC 16

Kabelverschraubung / *Cable gland* / *Presse-étoupe*: 4.1

3.2 EPIC® D A - V I N C I H - B

Sockelgehäuse / Surface mount base / Embase en saillie

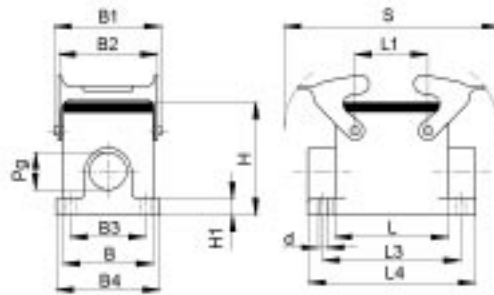

EPIC® H-B Gehäuse: Sockelgehäuse (1 Kabeleingang, Querbügel, hohe Bauform)

EPIC® H-B housings: surface mount base (1 cable entry, double locking lever, high version)

Boîtiers EPIC® H-B: embase en saillie (1 entrée de câble, double levier, version haute)

H-B 10

Artikel part article	Art.Nr. part No. N° art.	Art.Nr.: EP part No.: EP N° art.: EP	PG	L	L1	L2	L3	L4	B	B1	B2	B3	B4	B5	H	H1	H2	S	d	
H-B 10 SGRH 21	70035200	70037200	21		73	27		82	97	43	57,8	53	45	58		74	6		116	5,5
H-B 10 SGRH 29	70035400	70037400	29																	

Einsätze / Inserts / Inserts: 1.3: H-BE 10 / 1.5: H-BVE 3 / 1.7: H-DD 42 / 1.8: MC 10

Deckel / Cover / Couvercle: 5.1: H-B 10

Kabelverschraubung / Cable gland / Presse-étoupe: 4.1

H-B 16

Artikel part article	Art.Nr. part No. N° art.	Art.Nr.: EP part No.: EP N° art.: EP	PG	L	L1	L2	L3	L4	B	B1	B2	B3	B4	B5	H	H1	H2	S	d	
H-B 16 SGRH 21	70085200	70087200	21		93,3	47,5		105	117	43	57,8	53	45	58		84	6		136,5	5,5
H-B 16 SGRH 29	70085400	70087400	29																	

Einsätze / Inserts / Inserts: 1.3: H-BE 16 / 1.4: H-BS 6 / 1.5: H-BVE 6 / 1.6: H-D 40 / 1.7: H-DD 72 / 1.8: MC 16

Deckel / Cover / Couvercle: 5.1: H-B 16

Kabelverschraubung / Cable gland / Presse-étoupe: 4.1

H-B 24

Artikel part article	Art.Nr. part No. N° art.	Art.Nr.: EP part No.: EP N° art.: EP	PG	L	L1	L2	L3	L4	B	B1	B2	B3	B4	B5	H	H1	H2	S	d	
H-B 24 SGRH 21	70135200	70137200	21		120	74		132	144	43	57,8	53	45	58		84	6		163	5,5
H-B 24 SGRH 29	70135400*	70137400	29																	

Einsätze / Inserts / Inserts: 1.3: H-BE 24 / 1.5: H-BVE 10 / 1.6: H-D 64 / 1.7: H-DD 108 / 1.8: MC 24

Deckel / Cover / Couvercle: 5.1: H-B 24

Kabelverschraubung / Cable gland / Presse-étoupe: 4.1

3.2 EPIC® D A - V I N C I H - B

Sockelgehäuse / Surface mount base / Embase en saillie

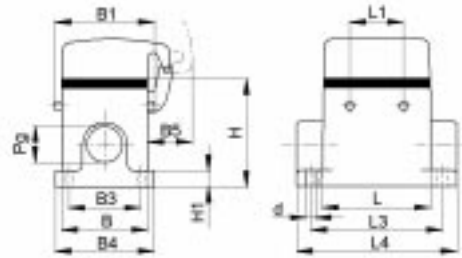

EPIC® H-B Gehäuse: Sockelgehäuse (Schutzdeckel, 2 Kabeleingänge, Bolzen für Querbügel)

EPIC® H-B housings: surface mount base (cover, 2 cable entries, bolts for double locking lever)

Boîtiers EPIC® H-B: embase en saillie (couverture, 2 entrées de câble, ergots pour double levier)

H-B 10

Artikel part article	Art.Nr. part No. N° art.	Art.Nr.: EP part No: EP N° art.: EP	PG	L	L1	L2	L3	L4	B	B1	B2	B3	B4	B5	H	H1	H2	S	d
H-B 10 SDRL-BO 16	10038000	70048000	16	73	27		82	94	43	57,8		40	54	25	57	4,5			5,5

Einsätze / Inserts / Inserts: 1.3: H-BE 10 / 1.5: H-BVE 3 / 1.7: H-DD 42 / 1.8: MC 10

Kabelverschraubung / Cable gland / Presse-étoupe: 4.1

H-B 16

Artikel part article	Art.Nr. part No. N° art.	Art.Nr.: EP part No: EP N° art.: EP	PG	L	L1	L2	L3	L4	B	B1	B2	B3	B4	B5	H	H1	H2	S	d
H-B 16 SDRL-BO 21	70096000	70098000	21	93	47,5		105	117	43	57,8		45	57	25	64	4,5			5,5

Einsätze / Inserts / Inserts: 1.3: H-BE 16 / 1.4: H-BS 6 / 1.5: H-BVE 6 / 1.6: H-D 40 / 1.7: H-DD 72 / 1.8: MC 16

Kabelverschraubung / Cable gland / Presse-étoupe: 4.1

H-B 24

Artikel part article	Art.Nr. part No. N° art.	Art.Nr.: EP part No: EP N° art.: EP	PG	L	L1	L2	L3	L4	B	B1	B2	B3	B4	B5	H	H1	H2	S	d
H-B 24 SDRL-BO 21	10109000	70148000	21	120	74		132	144	43	57,8		45	57	25	64	4,5			5,5

Einsätze / Inserts / Inserts: 1.3: H-BE 24 / 1.5: H-BVE 10 / 1.6: H-D 64 / 1.7: H-DD 108 / 1.8: MC 24

Kabelverschraubung / Cable gland / Presse-étoupe: 4.1

3.2 EPIC® D A - V I N C I H - B

Sockelgehäuse / Surface mount base / Embase en saillie

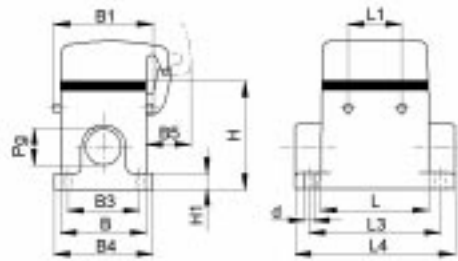

EPIC® H-B Gehäuse: Sockelgehäuse (Schutzdeckel, 2 Kabeleingänge, Bolzen für Querbügel, hohe Bauform)

EPIC® H-B housings: surface mount base (cover, 2 cable entries, bolts for double locking lever, high version)

Boîtiers EPIC® H-B: embase en saillie (covercle, 2 entrées de câble, ergots pour double levier, version haute)

H-B 10

Artikel part article	Art.Nr. part No. N° art.	Art.Nr.: EP part No.: EP N° art.: EP	PG	L	L1	L2	L3	L4	B	B1	B2	B3	B4	B5	H	H1	H2	S	d
H-B 10 SDRLH-BO 21	70046200	70048200	21		73	27		82	97	43	57,8		45	58	25	74	6		5,5
H-B 10 SDRLH-BO 29	70046400	70048400	29																

Einsätze / Inserts / Inserts: 1.3: H-BE 10 / 1.5: H-BVE 3 / 1.7: H-DD 42 / 1.8: MC 10

Kabelverschraubung / Cable gland / Presse-étoupe: 4.1

H-B 16

Artikel part article	Art.Nr. part No. N° art.	Art.Nr.: EP part No.: EP N° art.: EP	PG	L	L1	L2	L3	L4	B	B1	B2	B3	B4	B5	H	H1	H2	S	d
H-B 16 SDRLH-BO 21	70096200	70098200	21		93,3	47,5		105	117	43	57,8		45	58	25	84	6		5,5
H-B 16 SDRLH-BO 29	70096400	70098400	29																

Einsätze / Inserts / Inserts: 1.3: H-BE 16 / 1.4: H-BS 6 / 1.5: H-BVE 6 / 1.6: H-D 40 / 1.7: H-DD 72 / 1.8: MC 16

Kabelverschraubung / Cable gland / Presse-étoupe: 4.1

H-B 24

Artikel part article	Art.Nr. part No. N° art.	Art.Nr.: EP part No.: EP N° art.: EP	PG	L	L1	L2	L3	L4	B	B1	B2	B3	B4	B5	H	H1	H2	S	d
H-B 24 SDRLH-BO 21	70146200	70148200	21		120	74		132	144	43	57,8		45	58	25	84	6		5,5
H-B 24 SDRLH-BO 29	70146400	70148400	29																

Einsätze / Inserts / Inserts: 1.3: H-BE 24 / 1.5: H-BVE 10 / 1.6: H-D 64 / 1.7: H-DD 108 / 1.8: MC 24

Kabelverschraubung / Cable gland / Presse-étoupe: 4.1

3.2 EPIC® D A - V I N C I H - B

Sockelgehäuse / *Surface mount base* / *Embase en saillie*

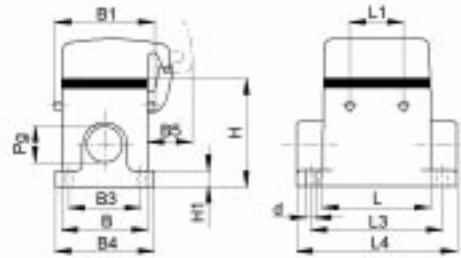

EPIC® H-B Gehäuse: Sockelgehäuse (Schutzdeckel, 1 Kabeleingang, Bolzen für Querbügel)

EPIC® H-B housings: surface mount base (cover, 1 cable entry, bolts for double locking lever)

Boîtiers EPIC® H-B: embase en saillie (couverture, 1 entrée de câble, ergots pour double levier)

H-B 10

Artikel <i>part</i> <i>article</i>	Art.Nr. <i>part No.</i> <i>N° art.</i>	Art.Nr.: EP <i>part No: EP</i> <i>N° art.: EP</i>	PG	L	L1	L2	L3	L4	B	B1	B2	B3	B4	B5	H	H1	H2	S	d
H-B 10 SDR-BO 16	10036000	70047000	16	73	27		82	94	43	57,8		40	54	25	57	4,5			5,5

Einsätze / *Inserts* / *Inserts*: 1.3: H-BE 10 / 1.5: H-BVE 3 / 1.7: H-DD 42 / 1.8: MC 10

Kabelverschraubung / *Cable gland* / *Presse-étoupe*: 4.1

H-B 16

Artikel <i>part</i> <i>article</i>	Art.Nr. <i>part No.</i> <i>N° art.</i>	Art.Nr.: EP <i>part No: EP</i> <i>N° art.: EP</i>	PG	L	L1	L2	L3	L4	B	B1	B2	B3	B4	B5	H	H1	H2	S	d
H-B 16 SDR-BO 21	10076000	70097000	21	93	47,5		105	117	43	57,8		45	57	25	64	4,5			5,5

Einsätze / *Inserts* / *Inserts*: 1.3: H-BE 16 / 1.4: H-BS 6 / 1.5: H-BVE 6 / 1.6: H-D 40 / 1.7: H-DD 72 / 1.8: MC 16

Kabelverschraubung / *Cable gland* / *Presse-étoupe*: 4.1

H-B 24

Artikel <i>part</i> <i>article</i>	Art.Nr. <i>part No.</i> <i>N° art.</i>	Art.Nr.: EP <i>part No: EP</i> <i>N° art.: EP</i>	PG	L	L1	L2	L3	L4	B	B1	B2	B3	B4	B5	H	H1	H2	S	d
H-B 24 SDR-BO 21	10107000*	70147000	21	120	74		132	144	43	57,8		45	57	25	64	4,5			5,5

Einsätze / *Inserts* / *Inserts*: 1.3: H-BE 24 / 1.5: H-BVE 10 / 1.6: H-D 64 / 1.7: H-DD 108 / 1.8: MC 24

Kabelverschraubung / *Cable gland* / *Presse-étoupe*: 4.1

3.2 EPIC® D A - V I N C I H - B

Sockelgehäuse / Surface mount base / Embase en saillie

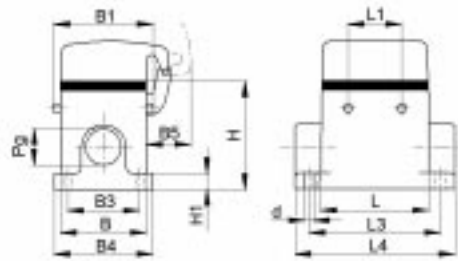

EPIC® H-B Gehäuse: Sockelgehäuse (Schutzdeckel, 1 Kabeleingang, Bolzen für Querbügel, hohe Bauform)
EPIC® H-B housings: surface mount base (cover, 1 cable entry, bolts for double locking lever, high version)
Boîtiers EPIC® H-B: embase en saillie (covercle, 1 entrée de câble, ergots pour double levier, version haute)

H-B 10

Artikel part article	Art.Nr. part No. N° art.	Art.Nr.: EP part No.: EP N° art.: EP	PG	L	L1	L2	L3	L4	B	B1	B2	B3	B4	B5	H	H1	H2	S	d
H-B 10 SDRH-BO 21	70045200	70047200	21		73	27		82	97	43	57,8		45	58	25	74	6		5,5
H-B 10 SDRH-BO 29	70045400	70047400	29																

Einsätze / Inserts / Inserts: 1.3: H-BE 10 / 1.5: H-BVE 3 / 1.7: H-DD 42 / 1.8: MC 10
 Kabelverschraubung / Cable gland / Presse-étoupe: 4.1

H-B 16

Artikel part article	Art.Nr. part No. N° art.	Art.Nr.: EP part No.: EP N° art.: EP	PG	L	L1	L2	L3	L4	B	B1	B2	B3	B4	B5	H	H1	H2	S	d
H-B 16 SDRH-BO 21	70095200	70097200	21		93,3	47,5		105	117	43	57,8		45	58	25	84	6		5,5
H-B 16 SDRH-BO 29	70095400	70097400	29																

Einsätze / Inserts / Inserts: 1.3: H-BE 16 / 1.4: H-BS 6 / 1.5: H-BVE 6 / 1.6: H-D 40 / 1.7: H-DD 72 / 1.8: MC 16
 Kabelverschraubung / Cable gland / Presse-étoupe: 4.1

H-B 24

Artikel part article	Art.Nr. part No. N° art.	Art.Nr.: EP part No.: EP N° art.: EP	PG	L	L1	L2	L3	L4	B	B1	B2	B3	B4	B5	H	H1	H2	S	d
H-B 24 SDRH-BO 21	70145200	70147200	21		120	74		132	144	43	57,8		45	58	25	84	6		5,5
H-B 24 SDRH-BO 29	70145400	70147400	29																

Einsätze / Inserts / Inserts: 1.3: H-BE 24 / 1.5: H-BVE 10 / 1.6: H-D 64 / 1.7: H-DD 108 / 1.8: MC 24
 Kabelverschraubung / Cable gland / Presse-étoupe: 4.1

3.2 EPIC® D A - V I N C I H - B

Kupplungsgehäuse / *Cable coupler hood* / *Capot prolongateur*

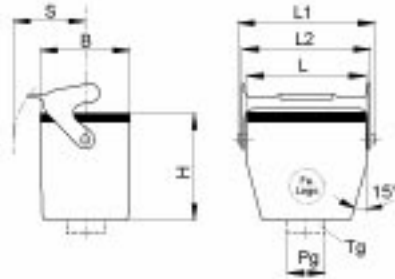

EPIC® H-B Gehäuse: Kupplungsgehäuse (Kabeleingang gerade, Längsbügel)

EPIC® H-B housings: cable coupler hood (top entry, single locking lever)

Boîtiers EPIC® H-B: capot prolongateur (sortie verticale, simple levier)

H-B 6

Artikel <i>part article</i>	Art.Nr. <i>part No. N° art.</i>	Art.Nr.: EP <i>part No.: EP N° art.: EP</i>	PG	L	L1	L2	L3	L4	B	B1	B2	B3	B4	B5	H	H1	H2	S	d
H-B 6 TBF 13,5	10014000*	-	13,5	60	74,8	70			43						54,8			44	
H-B 6 TBF 16	10024000	70011000	16																

Einsätze / *Inserts* / *Inserts*: 1.3: H-BE 6 / 1.7: H-DD 24 / 1.8: MC 6

Deckel / *Cover* / *Couvercle*: 5.1: H-B 6

Kabelverschraubung / *Cable gland* / *Presse-étoupe*: 4.1

H-B 10

Artikel <i>part article</i>	Art.Nr. <i>part No. N° art.</i>	Art.Nr.: EP <i>part No.: EP N° art.: EP</i>	PG	L	L1	L2	L3	L4	B	B1	B2	B3	B4	B5	H	H1	H2	S	d
H-B 10 TBF-LB 16	10046900	70043000	16	73	91	88,5			43						54,8			50	
H-B 10 TBF-LB 21	70042200	70043200	21																

Einsätze / *Inserts* / *Inserts*: 1.3: H-BE 10 / 1.5: H-BVE 3 / 1.7: H-DD 42 / 1.8: MC 10

Kabelverschraubung / *Cable gland* / *Presse-étoupe*: 4.1

H-B 16

Artikel <i>part article</i>	Art.Nr. <i>part No. N° art.</i>	Art.Nr.: EP <i>part No.: EP N° art.: EP</i>	PG	L	L1	L2	L3	L4	B	B1	B2	B3	B4	B5	H	H1	H2	S	d
H-B 16 TBF-LB 21	10086900	70093000	21	93,3	111	109,5			43						63,5			50	

Einsätze / *Inserts* / *Inserts*: 1.3: H-BE 16 / 1.4: H-BS 6 / 1.5: H-BVE 6 / 1.6: H-D 40 / 1.7: H-DD 72 / 1.8: MC 16

Kabelverschraubung / *Cable gland* / *Presse-étoupe*: 4.1

H-B 24

Artikel <i>part article</i>	Art.Nr. <i>part No. N° art.</i>	Art.Nr.: EP <i>part No.: EP N° art.: EP</i>	PG	L	L1	L2	L3	L4	B	B1	B2	B3	B4	B5	H	H1	H2	S	d
H-B 24 TBF-LB 21	10127900	70143000	21	120	138	136,5			43						63,8			50	
H-B 24 TBF-LB 29	10117900	70143200	29																

Einsätze / *Inserts* / *Inserts*: 1.3: H-BE 24 / 1.5: H-BVE 10 / 1.6: H-D 64 / 1.7: H-DD 108 / 1.8: MC 24

Kabelverschraubung / *Cable gland* / *Presse-étoupe*: 4.1

3.2 EPIC® D A - V I N C I H - B

Kupplungsgehäuse / Cable coupler hood / Capot prolongateur



EPIC® H-B Gehäuse: Kupplungsgehäuse (Kabeleingang gerade, Längsbügel, hohe Bauform)
EPIC® H-B housings: cable coupler hood (top entry, single locking lever, high version)
Boîtiers EPIC® H-B: capot prolongateur (sortie verticale, simple levier, version haute)

H-B 6

Artikel part article	Art.Nr. part No. N° art.	Art.Nr.: EP part No.: EP N° art.: EP	PG	L	L1	L2	L3	L4	B	B1	B2	B3	B4	B5	H	H1	H2	S	d
H-B 6 TBFH 21	70010200	70011200	21	60	74,8	70			43						74,8			44	
H-B 6 TBFH 29	70010400	70011400	29																

Einsätze / Inserts / Inserts: 1.3: H-BE 6 / 1.7: H-DD 24 / 1.8: MC 6 / 1.9: TB-H-BE 6, TB-H-D 16

Deckel / Cover / Couvercle: 5.1: H-B 6

Kabelverschraubung / Cable gland / Presse-étoupe: 4.1

H-B 10

Artikel part article	Art.Nr. part No. N° art.	Art.Nr.: EP part No.: EP N° art.: EP	PG	L	L1	L2	L3	L4	B	B1	B2	B3	B4	B5	H	H1	H2	S	d
H-B 10 TBFH-LB 21	70042400	70043400	16	73	91	88,5			43						74,8			50	
H-B 10 TBFH-LB 29	70042600	70043600	21																

Einsätze / Inserts / Inserts: 1.3: H-BE 10 / 1.5: H-BVE 3 / 1.7: H-DD 42 / 1.8: MC 10

Kabelverschraubung / Cable gland / Presse-étoupe: 4.1

H-B 16

Artikel part article	Art.Nr. part No. N° art.	Art.Nr.: EP part No.: EP N° art.: EP	PG	L	L1	L2	L3	L4	B	B1	B2	B3	B4	B5	H	H1	H2	S	d
H-B 16 TBFH-LB 21	70092200	70093200	16	93,3	111	109,5			43						78,8			50	
H-B 16 TBFH-LB 29	70092400	70093400	21																

Einsätze / Inserts / Inserts: 1.3: H-BE 16 / 1.4: H-BS 6 / 1.5: H-BVE 6 / 1.6: H-D 40 / 1.7: H-DD 72 / 1.8: MC 16

Kabelverschraubung / Cable gland / Presse-étoupe: 4.1

H-B 24

Artikel part article	Art.Nr. part No. N° art.	Art.Nr.: EP part No.: EP N° art.: EP	PG	L	L1	L2	L3	L4	B	B1	B2	B3	B4	B5	H	H1	H2	S	d
H-B 24 TBFH-LB 21	70142400	70143400	21	120	138	136,5			43						78,8			50	
H-B 24 TBFH-LB 29	70142600	70143600	29																

Einsätze / Inserts / Inserts: 1.3: H-BE 24 / 1.5: H-BVE 10 / 1.6: H-D 64 / 1.7: H-DD 108 / 1.8: MC 24

Kabelverschraubung / Cable gland / Presse-étoupe: 4.1

3.2 EPIC® D A - V I N C I H - B

Kupplungsgehäuse / *Cable coupler hood* / *Capot prolongateur*

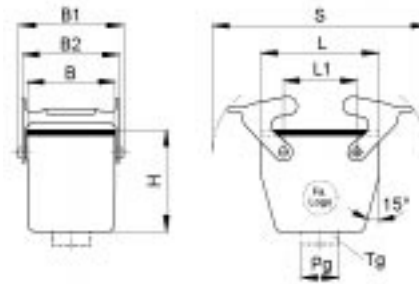

EPIC® H-B Gehäuse: Kupplungsgehäuse (Kabeleingang gerade, Querbügel)

EPIC® H-B housings: cable coupler hood (top entry, double locking lever)

Boîtiers EPIC® H-B: capot prolongateur (sortie verticale, double levier)

H-B 10

Artikel <i>part</i> <i>article</i>	Art.Nr. <i>part No.</i> <i>N° art.</i>	Art.Nr.: EP <i>part No: EP</i> <i>N° art.: EP</i>	PG	L	L1	L2	L3	L4	B	B1	B2	B3	B4	B5	H	H1	H2	S	d
H-B 10 TBF 16	10046000*	70041000	16		73	27			43	57,8	53				54,8				116
H-B 10 TBF 21	70040200	70041200	21																

Einsätze / *Inserts* / *Inserts*: 1.3: H-BE 10 / 1.5: H-BVE 3 / 1.7: H-DD 42 / 1.8: MC 10

Deckel / *Cover* / *Couvercle*: 5.1: H-B 10

Kabelverschraubung / *Cable gland* / *Presse-étoupe*: 4.1

H-B 16

Artikel <i>part</i> <i>article</i>	Art.Nr. <i>part No.</i> <i>N° art.</i>	Art.Nr.: EP <i>part No: EP</i> <i>N° art.: EP</i>	PG	L	L1	L2	L3	L4	B	B1	B2	B3	B4	B5	H	H1	H2	S	d
H-B 16 TBF 21	10086000*	70091000	21	93,3	47,5				43	57,8	53				63,6				136,5

Einsätze / *Inserts* / *Inserts*: 1.3: H-BE 16 / 1.4: H-BS 6 / 1.5: H-BVE 6 / 1.6: H-D 40 / 1.7: H-DD 72 / 1.8: MC 16

Deckel / *Cover* / *Couvercle*: 5.1: H-B 16

Kabelverschraubung / *Cable gland* / *Presse-étoupe*: 4.1

H-B 24

Artikel <i>part</i> <i>article</i>	Art.Nr. <i>part No.</i> <i>N° art.</i>	Art.Nr.: EP <i>part No: EP</i> <i>N° art.: EP</i>	PG	L	L1	L2	L3	L4	B	B1	B2	B3	B4	B5	H	H1	H2	S	d
H-B 24 TBF 21	10127000	70141000	21		120	74			43	57,8	53				63,8				163
H-B 24 TBF 29	10117000	70141200	29																

Einsätze / *Inserts* / *Inserts*: 1.3: H-BE 24 / 1.5: H-BVE 10 / 1.6: H-D 64 / 1.7: H-DD 108 / 1.8: MC 24

Deckel / *Cover* / *Couvercle*: 5.1: H-B 24

Kabelverschraubung / *Cable gland* / *Presse-étoupe*: 4.1

3.2 EPIC® D A - V I N C I H - B

Kupplungsgehäuse / Cable coupler hood / Capot prolongateur

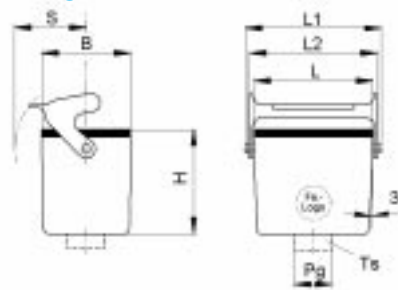

EPIC® H-B Gehäuse: Kupplungsgehäuse (Kabeleingang gerade, Querbügel, hohe Bauform)
EPIC® H-B housings: cable coupler hood (top entry, double locking lever, high version)
Boîtiers EPIC® H-B: capot prolongateur (sortie verticale, double levier, version haute)

H-B 10

Artikel part article	Art.Nr. part No. N° art.	Art.Nr.: EP part No: EP N° art.: EP	PG	L	L1	L2	L3	L4	B	B1	B2	B3	B4	B5	H	H1	H2	S	d
H-B 10 TBFH 21	70040400	70041400	21		73	27			43	57,8	53				74,8				116
H-B 10 TBFH 29	70040600	70041600	29																

Einsätze / Inserts / Inserts: 1.3: H-BE 10 / 1.5: H-BVE 3 / 1.7: H-DD 42 / 1.8: MC 10

Deckel / Cover / Couvercle: 5.1: H-B 10

Kabelverschraubung / Cable gland / Presse-étoupe: 4.1

H-B 16

Artikel part article	Art.Nr. part No. N° art.	Art.Nr.: EP part No: EP N° art.: EP	PG	L	L1	L2	L3	L4	B	B1	B2	B3	B4	B5	H	H1	H2	S	d
H-B 16 TBFH 21	70090200	70091200	21		93,3	47,5			43	57,8	53				78,8				136,5
H-B 16 TBFH 29	70090400	70091400	29																

Einsätze / Inserts / Inserts: 1.3: H-BE 16 / 1.4: H-BS 6 / 1.5: H-BVE 6 / 1.6: H-D 40 / 1.7: H-DD 72 / 1.8: MC 16

Deckel / Cover / Couvercle: 5.1: H-B 16

Kabelverschraubung / Cable gland / Presse-étoupe: 4.1

H-B 24

Artikel part article	Art.Nr. part No. N° art.	Art.Nr.: EP part No: EP N° art.: EP	PG	L	L1	L2	L3	L4	B	B1	B2	B3	B4	B5	H	H1	H2	S	d
H-B 24 TBFH 21	70140400	70141400	21		120	74			43	57,8	53				78,8				163
H-B 24 TBFH 29	70140600	70141600	29																

Einsätze / Inserts / Inserts: 1.3: H-BE 24 / 1.5: H-BVE 10 / 1.6: H-D 64 / 1.7: H-DD 108 / 1.8: MC 24

Deckel / Cover / Couvercle: 5.1: H-B 24

Kabelverschraubung / Cable gland / Presse-étoupe: 4.1

H-B 32

Artikel part article	Art.Nr. part No. N° art.	Art.Nr.: EP part No: EP N° art.: EP	PG	L	L1	L2	L3	L4	B	B1	B2	B3	B4	B5	H	H1	H2	S	d
H-B 32 TBFH 29	10139500	-	29		93,5	64,5			79	93,8	87,8				97	5			136,5

Einsätze / Inserts / Inserts: 1.3: H-BE 32 / 1.4: H-BS 12 / 1.6: H-D 80 / 1.7: H-DD 144 / 1.8: 2 x MC 16

Kabelverschraubung / Cable gland / Presse-étoupe: 4.1

3.3 EPIC® E c o H - B

Eco Set / Eco Set / Eco Set

Die Antwort auf geänderte Rahmenbedingungen. Der neue Standard, umweltschonend und kostengünstig. Die hochwertige Alulegierung und neue Gußwerkzeuge erlauben uns, auf die Beschichtung zu verzichten. Sie profitieren durch den einzigartigen EMV-Schutz. Lieferbar im Set: Anbau- und Tüllengehäuse der Baureihen H-B 16 und H-B 24.

Our answer to changing requirements. The new standard, environmentally friendly and cost-effective. The high-grade aluminium alloys and new casting tools enable us to dispense with the coating. You benefit from the unique EMC protection. Can be delivered as a set: hood and panel mount base from the H-B 16 and H-B 24 series.

Notre réponse aux conditions sans cesse changeantes. Le nouveau standard, respectueux de l'environnement et à prix intéressant. L'alliage alu de haute qualité et les nouveaux outils de moulage/démoulage nous ont permis de supprimer le revêtement. À vous de bénéficier de la protection CEM unique de ce système. Livrable en kit complet: embase et boîtier à capot des séries H-B 16 et H-B 24.

3.3 EPIC® Eco H - B

Eco Set / Eco Set / Eco Set

Technische Daten

Vorschriften und Zulassungen: . . . Bauartnorm DIN 43652

- Temperaturbereich: -40°C - +125°C
- Schutzart: IP 65 nach DIN VDE 0470
- Werkstoff: Aluminium-Legierung

Technical Data

Specification: DIN 43652

- Temperature range: -40°C - +125°C
- Protection class: IP 65 according to DIN VDE 0470
- Material: aluminium alloy

Caractéristiques techniques

Règlements et homologations: . . . DIN 43652

- Plage de température: -40°C - +125°C
- Protection: IP 65 suivant DIN VDE 0470
- Matériau: alliage AL

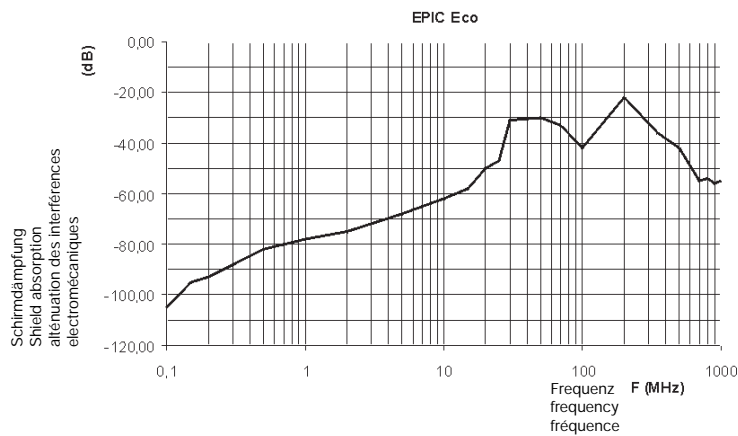

3.3 EPIC® Eco H - B

Eco Set / Eco Set / Eco Set

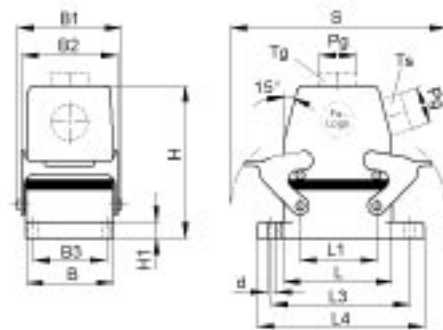

EPIC® Eco Set: Tülle/Anbaugeschäuse (Kabeleingang gerade, Querbügel, Kabelverschraubung)
 EPIC® Eco Set: hood/panel mount base (top entry, double locking lever, cable gland)
 EPIC® Eco Set: capot/embase encastrée (sortie verticale, double levier, presse-étoupe)

H-B 16

Artikel part article	Art.Nr. part No. N° art.	PG	L	L1	L2	L3	L4	B	B1	B2	B3	B4	B5	H	H1	H2	S	d	
H-B 16 TG / H-B 16 AG	70364000*	21																	
H-B 16 TG / H-B 16 AG	70364200*	29	93,3	47,5		103	113	43	57,8	53	32			88,8	4			136,5	4,3

Einsätze / Inserts / Inserts: 1.3: H-BE 16 / 1.4: H-BS 6 / 1.5: H-BVE 6 / 1.6: H-D 40 / 1.7: H-DD 72 / 1.8: MC 16 / 1.9: TB-H-BE 16, TB-H-D 40
 Deckel / Cover / Couvercle: 5.1: H-B 16

H-B 24

Artikel part article	Art.Nr. part No. N° art.	PG	L	L1	L2	L3	L4	B	B1	B2	B3	B4	B5	H	H1	H2	S	d	
H-B 24 TG / H-B 24 AG	70366000*	21																	
H-B 24 TG / H-B 24 AG	70366200*	29	120	74		130	140	43	57,8	53	32			88,8	4			163	4,3

Einsätze / Inserts / Inserts: 1.3: H-BE 24 / 1.5: H-BVE 10 / 1.6: H-D 64 / 1.7: H-DD 108 / 1.8: MC 24 / 1.9: TB-H-BE 24, TB-H-D 64
 Deckel / Cover / Couvercle: 5.1: H-B 24

Jetzt neu!

H-B 6 - H-B 24
 Anbau-/Tüllengehäuse als Einzelkomponenten
 in EPIC® Eco Version

New!

H-B 6 - H-B 24 panel mount base/hood as separat
 components in version Epic® Eco.

Nouveauté!

Dans la version EPIC® Eco sont maintenant
 disponibles les embases et les capots séparément.

3.3 EPIC® Eco H - B

Eco Set / Eco Set / Eco Set

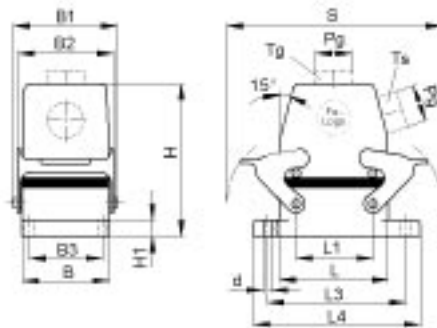

EPIC® Eco Set: Tülle/Anbaugehäuse (Kabeleingang seitlich, Querbügel, Kabelverschraubung)

EPIC® Eco Set: hood/panel mount base (side entry, double locking lever, cable gland)

EPIC® Eco Set: capot/embase encastrée (sortie latérale, double levier, presse-étoupe)

H-B 16

Artikel part article	Art.Nr. part No. N° art.	PG	L	L1	L2	L3	L4	B	B1	B2	B3	B4	B5	H	H1	H2	S	d	
H-B 16 TS / H-B 16 AG	70365000*	21																	
H-B 16 TS / H-B 16 AG	70365200*	29	93,3	47,5		103	113	43	57,8	53	32			88,8	4			136,5	4,3

Einsätze / Inserts / Inserts: 1.3: H-BE 16 / 1.4: H-BS 6 / 1.5: H-BVE 6 / 1.6: H-D 40 / 1.7: H-DD 72 / 1.8: MC 16 / 1.9: TB-H-BE 16, TB-H-D 40

Deckel / Cover / Couvercle: 5.1: H-B 16

H-B 24

Artikel part article	Art.Nr. part No. N° art.	PG	L	L1	L2	L3	L4	B	B1	B2	B3	B4	B5	H	H1	H2	S	d	
H-B 24 TS / H-B 24 AG	70367000*	21																	
H-B 24 TS / H-B 24 AG	70367200*	29	120	74		130	140	43	57,8	53	32			88,8	4			163	4,3

Einsätze / Inserts / Inserts: 1.3: H-BE 24 / 1.5: H-BVE 10 / 1.6: H-D 64 / 1.7: H-DD 108 / 1.8: MC 24 / 1.9: TB-H-BE 24, TB-H-D 64

Deckel / Cover / Couvercle: 5.1: H-B 24

Jetzt neu !

H-B 6 - H-B 24
Anbau-/Tüllengehäuse als Einzelkomponenten
in EPIC® Eco Version

New !

H-B 6 - H-B 24 panel mount base/hood as separat
components in version Epic® Eco.

Nouveauté !

Dans la version EPIC® Eco sont maintenant
disponibles les embases et les capots séparément.

3.3 EPIC® Eco H - B

Eco Set / Eco Set / Eco Set

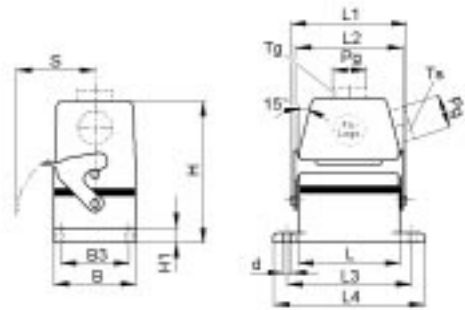

EPIC® Eco Set: Tülle/Anbaugehäuse (Kabeleingang gerade, Längsbügel, Kabelverschraubung)
 EPIC® Eco Set: hood/panel mount base (top entry, single locking lever, cable gland)
 EPIC® Eco Set: capot/embase encastrée (sortie verticale, simple levier, presse-étoupe)

H-B 16

Artikel part article	Art.Nr. part No. N° art.	PG	L	L1	L2	L3	L4	B	B1	B2	B3	B4	B5	H	H1	H2	S	d	
H-B 16 TG / H-B 16 AG-LB	70364100*	21																	
H-B 16 TG / H-B 16 AG-LB	70364300*	29	93,3	111	109,5	103	113	43			32			88,8	4		50	4,3	

Einsätze / Inserts / Inserts: 1.3: H-BE 16 / 1.4: H-BS 6 / 1.5: H-BVE 6 / 1.6: H-D 40 / 1.7: H-DD 72 / 1.8: MC 16 / 1.9: TB-H-BE 16, TB-H-D 40

H-B 24

Artikel part article	Art.Nr. part No. N° art.	PG	L	L1	L2	L3	L4	B	B1	B2	B3	B4	B5	H	H1	H2	S	d	
H-B 24 TG / H-B 24 AG-LB	70366100*	21																	
H-B 24 TG / H-B 24 AG-LB	70366300*	29	120	138	136,5	130	140	43			32			88,8	4		50	4,3	

Einsätze / Inserts / Inserts: 1.3: H-BE 24 / 1.5: H-BVE 10 / 1.6: H-D 64 / 1.7: H-DD 108 / 1.8: MC 24 / 1.9: TB-H-BE 24, TB-H-D 64

Jetzt neu!

H-B 6 - H-B 24
 Anbau-/Tüllengehäuse als Einzelkomponenten
 in EPIC® Eco Version

New!

H-B 6 - H-B 24 panel mount base/hood as separat
 components in version Epic® Eco.

Nouveauté!

Dans la version EPIC® Eco sont maintenant
 disponibles les embases et les capots séparément.

3.3 EPIC® Eco H - B

Eco Set / Eco Set / Eco Set

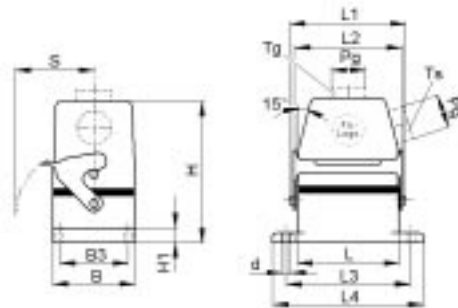

EPIC® Eco Set: Tülle/Anbaugehäuse (Kabeleingang seitlich, Längsbügel, Kabelverschraubung)

EPIC® Eco Set: hood/panel mount base (top entry, single locking lever, cable gland)

EPIC® Eco Set: capot/embase encastrée (sortie latérale, simple levier, presse-étoupe)

H-B 16

Artikel part article	Art.Nr. part No. N° art.	PG	L	L1	L2	L3	L4	B	B1	B2	B3	B4	B5	H	H1	H2	S	d	
H-B 16 TS / H-B 16 AG-LB	70365100*	21																	
H-B 16 TS / H-B 16 AG-LB	70365300*	29	93,3	111	109,5	103	113	43				32		88,8	4		50	4,3	

Einsätze / Inserts / Inserts: 1.3: H-BE 16 / 1.4: H-BS 6 / 1.5: H-BVE 6 / 1.6: H-D 40 / 1.7: H-DD 72 / 1.8: MC 16 / 1.9: TB-H-BE 16, TB-H-D 40

H-B 24

Artikel part article	Art.Nr. part No. N° art.	PG	L	L1	L2	L3	L4	B	B1	B2	B3	B4	B5	H	H1	H2	S	d	
H-B 24 TS / H-B 24 AG-LB	70367100*	21																	
H-B 24 TS / H-B 24 AG-LB	70367300*	29	120	138	136,5	130	140	43				32		88,8	4		50	4,3	

Einsätze / Inserts / Inserts: 1.3: H-BE 24 / 1.5: H-BVE 10 / 1.6: H-D 64 / 1.7: H-DD 108 / 1.8: MC 24 / 1.9: TB-H-BE 24, TB-H-D 64

Jetzt neu!

H-B 6 - H-B 24
Anbau-/Tüllengehäuse als Einzelkomponenten
in EPIC® Eco Version

New!

H-B 6 - H-B 24 panel mount base/hood as separat
components in version Epic® Eco.

Nouveauté!

Dans la version EPIC® Eco sont maintenant
disponibles les embases et les capots séparément.

4.1 EPIC® CERTOSA

Kabelverschraubungen / *Cable glands* / *Presse-étoupes*

Als notwendige Ergänzung für Steckverbinder bietet CONTACT einfach zu montierende Kabelverschraubungen an, die den Anforderungen an Funktionssicherheit, EMV-Schutz und Kältebeständigkeit gerecht werden.

Cable Glands are an important supplement to CONTACT's range of connectors. Our glands ensure that the IP rating of the connectors is not prejudiced, whilst offering an extensive variety of functions including EMC protection.

Comme complément ingénieux au connecteur nous vous proposons des presse-étoupes, avec un système EMV (Compatibilité Electro Magnétique ou continuité de masse).

4.1 EPIC® CERTOSA

Kabelverschraubungen / Cable glands / Presse-étoupes

Kabelverschraubungen / Cable glands / Presse-étoupes

EPIC® SP (Kunststoff, Einschnittdichtring / plastic, split seal / plastique, joint multiple)

EPIC® SM (Metall, Einschnittdichtring / metal, split seal / métallique, joint multiple)

SKINTOP® ST (Kunststoff / plastic / plastique)

SKINTOP® BS (Kunststoff, Biegeschutzspirale / plastic, spiral bend prevention / plastique, spirale anti-torsion)

SKINTOP® MS (Metall / metal / métallique)

SKINTOP® MS-SC (Metall, EMV-Schutz / metal, EMC protection / métallique, Protection CEM)

SKINDICHT® SK (Metall, Zugentlastung / metal, traction relief / métallique, amarrage de câble)

SKINDICHT® SH (Metall, Zugentlastung, Biegeschutz / metal, traction relief, bend prevention / métallique, amarrage de câble, anti-torsion)

SKINDICHT® SR (Metall, Zugentlastung, korrosionsbeständig, / metal, traction relief, corrosion resistant / métallique, amarrage de câble, résistant à la corrosion)

SKINDICHT® ME (Metall, Erweiterung / metal, enlarging / métallique, amplificateur)

SKINDICHT® MR (Metall, Reduzierung / metal, reducing / métallique, reducteur)

SKINDICHT® BL (Metall, Verschlußschraube / metal, plug / métallique, bouchons de fermeture)

SKINDICHT® BLK (Kunststoff, Verschlußschraube / plastic, plug / plastique, bouchons de fermeture)

Gewindemaße / Thread dimensions / Dimension du filetage

Technische Daten für den Einbau

Technical data for assembly

Caractéristiques techniques de montage

PG-Gewinde <i>Pg-Thread</i> <i>Pas PG</i>	Nenngewinde <i>Nominal thread</i> <i>Dimension du filetage</i>			
DIN 40430	Ø d ₁	Ø d ₂	p	Ø d ₃
PG 7	11,28	12,50	1,27	13,0 ± 0,2
PG 9	13,35	15,20	1,41	15,7 ± 0,2
PG 11	17,26	18,60	1,41	19,0 ± 0,2
PG 13,5	19,06	20,40	1,41	21,0 ± 0,2
PG 16	21,16	22,50	1,41	23,0 ± 0,2
PG 21	26,78	28,30	1,588	28,8 ± 0,2
PG 29	35,48	37,00	1,588	37,5 ± 0,3
PG 36	45,48	47,00	1,588	47,5 ± 0,3
PG 42	52,48	54,00	1,588	54,5 ± 0,3
PG 48	57,73	59,30	1,588	59,8 ± 0,3

d₁ = Kern-Ø

d₁ = core diameter

d₁ = diamètre 1ère couche (en parlant de câble)

d₂ = Außen-Ø

d₂ = outside diameter

d₂ = diamètre extérieur

d₃ = Bohrungs-Ø

d₃ = bore diameter

d₃ = diamètre de perçage

p = Steigung

p = pitch

p = pas

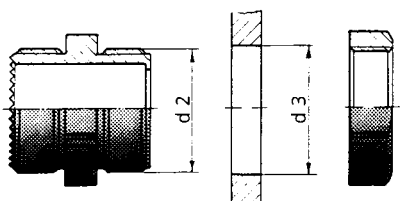

Metr. Gewinde

Metric thread

Pas Métrique

DIN 46319	Ø d ₁	Ø d ₂	p	Ø d ₃
M 12 x 1,5	10,38	12	1,5	12,5 ± 0,2
M 16 x 1,5	14,38	16	1,5	16,5 ± 0,2
M 20 x 1,5	18,38	20	1,5	20,5 ± 0,2
M 25 x 1,5	23,38	25	1,5	25,5 ± 0,2
M 32 x 1,5	30,38	32	1,5	32,5 ± 0,2
M 40 x 1,5	38,38	40	1,5	40,5 ± 0,3
M 50 x 1,5	48,38	50	1,5	50,5 ± 0,3
M 63 x 1,5	61,38	63	1,5	64,0 ± 0,3

Nenngewinde

Nominal thread

Dimension du filetage

PG-Gewinde

Pg-Thread

Pas PG

DIN 89280	Ø d ₁	Ø d ₂	p	Ø d ₃
M 18 x 1,5	16,38	18	1,5	18,5 ± 0,2
M 24 x 1,5	22,38	24	1,5	24,5 ± 0,2
M 30 x 2,0	27,34	30	2,0	30,5 ± 0,2
M 36 x 2,0	33,34	36	2,0	36,5 ± 0,2
M 45 x 2,0	42,34	45	2,0	45,5 ± 0,3
M 56 x 2,0	53,34	58	2,0	57,0 ± 0,3
M 72 x 2,0	68,82	72	2,0	73,0 ± 0,3

Nenngewinde

Nominal thread

Dimension du filetage

4.1 EPIC® CERTOSA

Kabelverschraubungen / Cable glands / Presse-étoupes

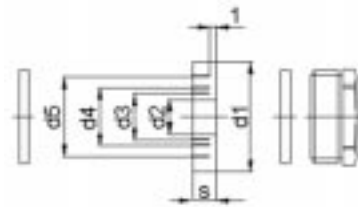

EPIC® SP

Art.Nr. part No. N° art.	PG	d1	d2	Kabel Ø cable Ø câble Ø	d3	Kabel Ø cable Ø câble Ø	d4	Kabel Ø cable Ø câble Ø	d5	Kabel Ø cable Ø câble Ø	s	VPE packing unit conditionnement
12957100*	11	16,5	7,5	6,5-8,5	10	9-11	12,5	11,5-13,5			6	5
12957200	13,5	18,3	7,5	6,5-8,5	10	9-11	12,5	11,5-13,5			6	5
12957300	16	20,4	7,5	6,5-8,5	10	9-11	12,5	11,5-13,5	15	149-16	7	5
12957400	21	25,9	10	9-11	13	12-14	16	15-17	19	18-20	8	5

Material / material / matière: Polystyrol

Schutzart / protection class / degré de protection: IP 54 (DIN 46320)

Temperaturbereich / temperature range / gamme de température: -20° C - +55° C

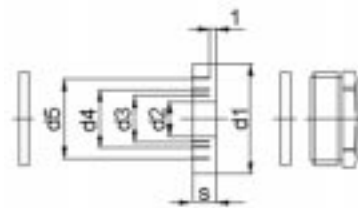

EPIC® SM

Art.Nr. part No. N° art.	PG	d1	d2	Kabel Ø cable Ø câble Ø	d3	Kabel Ø cable Ø câble Ø	d4	Kabel Ø cable Ø câble Ø	d5	Kabel Ø cable Ø câble Ø	s	VPE packing unit conditionnement
12954100	9	13,3	5	4-6	7,5	6,5-8,5	10	9-11			5,5	5
12954200	11	16,5	7,5	6,5-8,5	10	9-11	12,5	11,5-13,5			6	5
12954300*	13,5	18,3	7,5	6,5-8,5	10	9-11	12,5	11,5-13,5			6	5
12954400*	16	20,4	7,5	6,5-8,5	10	9-11	12,5	11,5-13,5	15	14-16	7	5
12954500*	21	25,9	10	9-11	13	12-14	16	15-17	19	18-20	8	5
12954600*	29	34,7	18	17-19	21	20-22	24	23-25	27	26-28	9,5	5
12954700	36	44,7	24	23-25	27	26-28	30	29-31	33	32-34	12	5
12954800	42	51,7	30	29-31	33	32-34	36	35-37	39	38-40	14	5

Material / material / matière: Metall / metal / métallique

Schutzart / protection class / degré de protection: IP 54 (DIN 46320)

Temperaturbereich / temperature range / gamme de température: -40° C - +125° C

4.1 EPIC® CERTOSA

Kabelverschraubungen / Cable glands / Presse-étoupes

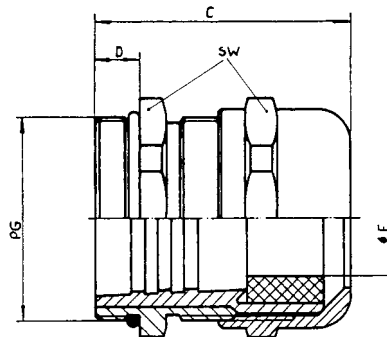

SKINTOP® ST

Artikel part article	Art.Nr. part No. N° art.	PG	Kabel Ø cable Ø câble Ø	Farbe colour couleur	C	D	VPE packing unit conditionnement
ST 9	5301 5010	9	3,5-8	grau / grey / grise	36	8	100
ST 11	5301 5020	11	4-10	grau / grey / grise	38	8	100
ST 13,5	5301 5030	13,5	6-12	grau / grey / grise	41	9	100
ST 16	5301 5040	16	9-14	grau / grey / grise	44	10	50
ST 21	5301 5050	21	13-18	grau / grey / grise	49	11	50
ST 29	5301 5060	29	14-25	grau / grey / grise	56	11	25
ST 36	5301 5070	36	24-32	grau / grey / grise	66	13	10

Material / material / matière: Polyamid

Schutzart / protection class / degré de protection: IP 68

Temperaturbereich / temperature range / gamme de température: -20° C – +80° C

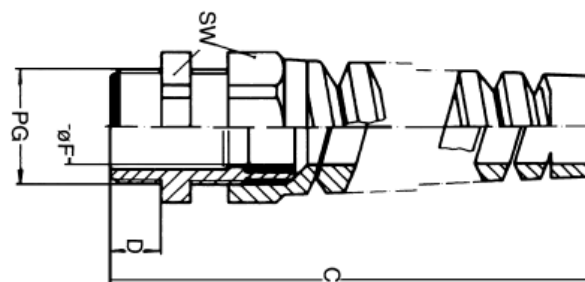

SKINTOP® BS

Artikel part article	Art.Nr. part No. N° art.	PG	Kabel Ø cable Ø câble Ø	Farbe colour couleur	C	D	VPE packing unit conditionnement
BS 9	5301 5610	9	3,5-8	grau / grey / grise	73,5	8	100
BS 11	5301 5620	11	4-10	grau / grey / grise	86	8	100
BS 13,5	5301 5630	13,5	6-12	grau / grey / grise	98	9	50
BS 16	5301 5640	16	9-14	grau / grey / grise	111,5	10	25
BS 21	5301 5650	21	13-18	grau / grey / grise	129	11	25

Material / material / matière: Polyamid

Schutzart / protection class / degré de protection: IP 68

Temperaturbereich / temperature range / gamme de température: -20° C – +80° C

4.1 EPIC® CERTOSA

Kabelverschraubungen / Cable glands / Presse-étoupes

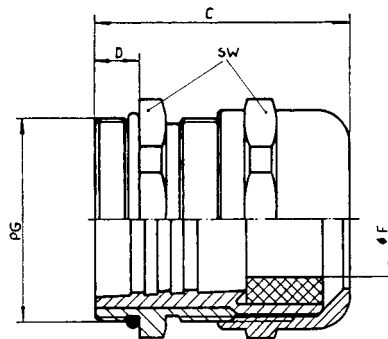

SKINTOP® MS

Artikel part article	Art.Nr. part No. N° art.	PG	Kabel Ø cable Ø câble Ø	C	D	VPE packing unit conditionnement
MS 9	5201 5710	9	3-8	29	6	100
MS 11	5201 5720	11	4-10	32	6	50
MS 13,5	5201 5730	13,5	5-12	34	6,5	50
MS 16	5201 5740	16	8-14	35	6,5	50
MS 21	5201 5750	21	11-18	40	7	25
MS 29	5201 5760	29	16-25	48	8	25
MS 36	5201 5765	36	19-32	62	15	10

Material / material / matière: Metall / metal / métallique

Schutzart / protection class / degré de protection: IP 68 (5 bar)

Temperaturbereich / temperature range / gamme de température: -40° C – +125° C

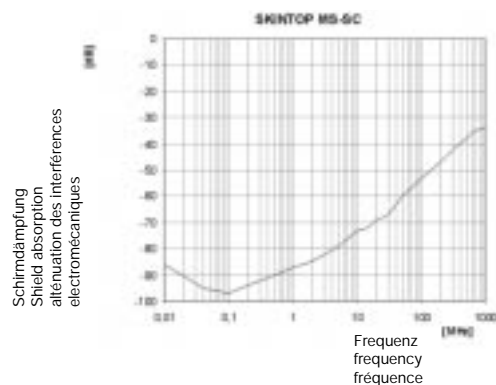

SKINTOP® MS-SC (EMV-Schutz / EMC Protection / Protection CEM)

Artikel part article	Art.Nr. part No. N° art.	PG	Kabel Ø cable Ø câble Ø	Minstdurchmesser über Geflecht (mm) minimum diameter over braiding (mm) diamètre mini par-dessus blindage (mm)	VPE packing unit conditionnement
MS-SC 9	5311 2210	9	4-7,5	4	50
MS -SC11	5311 2220	11	4-10	4	50
MS-SC 13,5	5311 2230	13,5	6-12	4	25
MS-SC 16	5311 2240	16	8-14	6	25
MS-SC 21	5311 2250	21	11-17,5	8	25
MS-SC 29	5311 2260	29	16-25	13	10

Material / material / matière: Metall / metal / métallique

Schutzart / protection class / degré de protection: IP 68

Temperaturbereich / temperature range / gamme de température: -40° C – +125° C

4.1 EPIC® CERTOSA

Kabelverschraubungen / Cable glands / Presse-étoupes

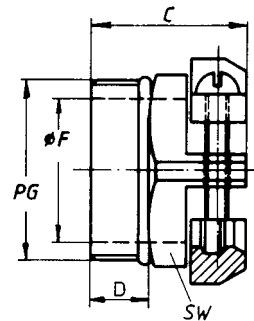

SKINDICHT® SK

Artikel part article	Art.Nr. part No. N° art.	Kabel Ø cable Ø câble Ø	C	D	VPE packing unit conditionnement
SK 9	5200 4230	6-12	16,5	6	50
SK 11	5200 4240	7-15	16,5	6	50
SK 13,5	5200 4250	12-16,5	18,5	7,5	25
SK 16	5200 4260	13-18	19	7,5	25
SK 21	5200 4270	15-23	22,5	8	25

Material / material / matière: Metall / metal / métallique
Schutzart / protection class / degré de protection: IP 20

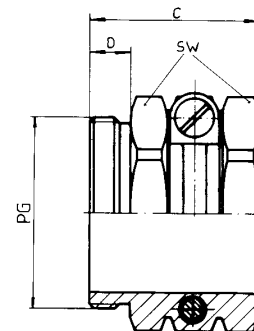

SKINDICHT® SH

Artikel part article	Art.Nr. part No. N° art.	Kabel Ø cable Ø câble Ø	C	D	VPE packing unit conditionnement
SH 9	5200 0840	10-12,5	20,5	6	50
SH 11	5200 0850	11-15	21,5	6	50
SH 13,5	5200 0860	14-16,5	24	7,5	25
SH 16	5200 0870	15-18	26	7,5	25
SH 21	5200 0880	18-23,5	29	8	25
SH 29	5200 0890	23-31	33	8	10
SH 36	5200 0900	29-40,5	36,5	9,5	10

Material / material / matière: Metall / metal / métallique
Schutzart / protection class / degré de protection: IP 20

4.1 EPIC® CERTOSA

Kabelverschraubungen / Cable glands / Presse-étoupes

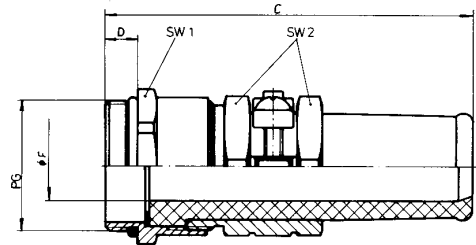

SKINDICHT® SR

Artikel <i>part article</i>	Art.Nr. <i>part No. N° art.</i>	Kabel Ø <i>cable Ø câble Ø</i>	C	D	VPE <i>packing unit conditionnement</i>
SR 09 / 07	5200 1000	5,5-7	52	6	50
SR 11 / 07	5200 1010	5,5-7	56	6	25
SR 11 / 09	5200 1020	7,5-9	56	6	25
SR 13 / 09	5200 1030	7,5-9	62	6,5	25
SR 13 / 11	5200 1040	9-11	62	6,5	25
SR 13 / 13	5200 1050	11-13	62	6,5	25
SR 16 / 13	5200 1060	11,5-13	67	6,5	25
SR 16 / 15	5200 1070	13-15	67	6,5	25
SR 21 / 15	5200 1080	13,5-15	79	7	25
SR 21 / 17	5200 1090	15-17	79	7	25
SR 21 / 19	5200 1100	17-19	79	7	25
SR 21 / 20	5200 1110	18-20	79	7	25
SR 29 / 20	5200 1120	18-20	91	8	10
SR 29 / 23	5200 1130	21-23	91	8	10
SR 29 / 25	5200 1140	23-25	91	8	10
SR 36 / 26	5200 1150	23-26	110	9	5
SR 36 / 30	5200 1160	27-30	110	9	5

Material / *material / matière*: Metall / *metal / métallique*

Schutzart / *protection class / degré de protection*: IP 65

Temperaturbereich / *temperature range / gamme de température*: -40° C – +125° C

4.1 EPIC® CERTOSA

Kabelverschraubungen / Cable glands / Presse-étoupes



SKINDICHT® ME (Erweiterung / enlarging / amplificateur)

Artikel <i>part</i> <i>article</i>	Art.Nr. <i>part No.</i> <i>N° art.</i>	VPE <i>packing unit</i> <i>conditionnement</i>
ME 9 / 11	5200 4000	100
ME 11 / 13,5	5200 4020	100
ME 13,5 / 16	5200 4050	100
ME 16 / 21	5200 4070	50
ME 21 / 29	5200 4090	50
ME 29 / 36	5200 4100	50
ME 36 / 42	5200 4110	10

Material / *material* / *matière*: Metall / *metal* / *métallique*
DIN 46320



SKINDICHT® MR (Reduzierung / reducing / reducteur)

Artikel <i>part</i> <i>article</i>	Art.Nr. <i>part No.</i> <i>N° art.</i>	VPE <i>packing unit</i> <i>conditionnement</i>
MR 9 / 7	5200 3750	100
MR 11 / 9	5200 3770	100
MR 13,5 / 11	5200 3800	100
MR 16 / 13,5	5200 3840	100
MR 21 / 16	5200 3870	50
MR 29 / 21	5200 3900	50
MR 36 / 29	5200 3930	50

Material / *material* / *matière*: Metall / *metal* / *métallique*
DIN 46320

4.1 EPIC® CERTOSA

Kabelverschraubungen / Cable glands / Presse-étoupes



SKINDICHT® BL

Artikel <i>part</i> <i>article</i>	Art.Nr. <i>part No.</i> <i>N° art.</i>	VPE <i>packing unit</i> <i>conditionnement</i>
BL 7	5200 2680	100
BL 9	5200 3390	100
BL 11	5200 3400	100
BL 13,5	5200 3410	100
BL 16	5200 3420	100
BL 21	5200 3430	100
BL 29	5200 3440	50
BL 36	5200 3450	50
BL 42	5200 3460	50

Material / *material* / *matière*: Metall / *metal* / *métallique*



SKINDICHT® BLK

Artikel <i>part</i> <i>article</i>	Art.Nr. <i>part No.</i> <i>N° art.</i>	VPE <i>packing unit</i> <i>conditionnement</i>
BLK 7	5200 5949	100
BLK 9	5200 5950	100
BLK 11	5200 5960	100
BLK 13,5	5200 5970	100
BLK 16	5200 5980	100
BLK 21	5200 5990	100
BLK 29	5200 6000	100
BLK 36	5200 6010	100
BLK 42	5200 6020	100

Material / *material* / *matière*: Polystyrol

5.1 EPIC® D U C O

Schutzdeckel / *Protective cover* / *Couvercle de protection*

Die Schutzdeckel von CONTACT aus schlagfestem Kunststoff bieten eine wirksame Abschirmung vor Umwelteinflüssen. So sind die Einsätze im ungesteckten Zustand einfach und wirkungsvoll geschützt.

CONTACT protective covers, made of impact-resistant plastic provide effective protection against environmental influences. In this way, inserts are easily and effectively protected when not connected.

Les couvercles de protection de CONTACT en matière synthétique résistante aux chocs stable offre un écran efficace contre les intempéries. Ce qui a pour effet de protéger simplement et efficacement les inserts lorsqu'ils ne sont pas enfichés.



5.1 EPIC® D U C O

Schutzdeckel / *Protective cover* / *Couvercle de protection*

Technische Daten:

- Material: Thermoplast
- Temperaturbereich: -40 - +125°C

Technical Data:

- *Material: thermoplastic resin*
- *Temperature range: -40 - +125°C*

Caractéristiques techniques:

- *Materieau: plastique thermoformé*
- *Gamme de température: . . . -40 - +125°C*

5.1 EPIC® D U C O

Schutzdeckel / *Protective cover* / *Couvercle de protection*



Schutzdeckel für H-A 3 Gehäuse mit Stifteinsatz *Protective cover for H-A 3 housings with male insert* *Couvercle pour boîtiers H-A 3 avec insert mâle*

H-A 3

Artikel <i>part</i> <i>article</i>	Art.Nr. <i>part No.</i> <i>N° art.</i>	Fangschnur <i>attachment string</i> <i>cordon d'armarage</i>
H-A 3 KDB-S	10430000	
H-A 3 KDBF-S	10430400	●

Schutzdeckel für H-A 3 Gehäuse mit Buchseneinsatz *Protective cover for H-A 3 housings with female insert* *Couvercle pour boîtiers H-A 3 avec insert femelle*

H-A 3

Artikel <i>part</i> <i>article</i>	Art.Nr. <i>part No.</i> <i>N° art.</i>	Fangschnur <i>attachment string</i> <i>cordon d'armarage</i>
H-A 3 KDB-B	10430300	
H-A 3 KDBF-B	10430100*	●

Schutzdeckel für Anbaughäuse / Sockelgehäuse / Kupplungsgehäuse *Protective cover for panel mount base / surface mount base / Cable connector hood* *Couvercle pour embase encastrée / embase en saillie / capot prolongateur*

H-A 10-32

Artikel <i>part</i> <i>article</i>	Art.Nr. <i>part No.</i> <i>N° art.</i>	Fangschnur <i>attachment string</i> <i>cordon d'armarage</i>
H-A 10 KDB	10457700	
H-A 16 KDB	10469700	
H-A 32 KDB	10481700	
H-A 10 KDBF	10457500*	●
H-A 16 KDBF	10469500*	●
H-A 32 KDBF	10481500*	●

Schutzdeckel für Tüllengehäuse *Protective cover for hood* *Couvercle pour capot*

H-A 10-32

Artikel <i>part</i> <i>article</i>	Art.Nr. <i>part No.</i> <i>N° art.</i>	Fangschnur <i>attachment string</i> <i>cordon d'armarage</i>
H-A 10 KDT	10457800	
H-A 16 KDT	10469800	
H-A 32 KDT	10481800	
H-A 10 KDTF	10457600	●
H-A 16 KDTF	10469600*	●
H-A 32 KDTF	10481600*	●

5.1 EPIC® D U C O

Schutzdeckel / *Protective cover* / *Couvercle de protection*

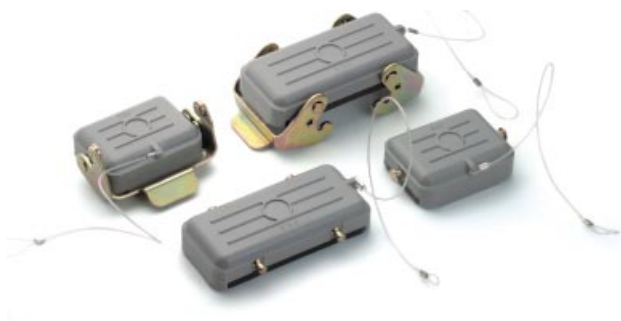

Schutzdeckel für Anbaughäuse / Sockelgehäuse / Kupplungsgehäuse
Protective cover for panel mount base / surface mount base / Cable connector hood
Couvercle pour embase encastrée / embase en saillie / capot prolongateur

H-B 6-24

Artikel <i>part</i> <i>article</i>	Art.Nr. <i>part No.</i> <i>N° art.</i>	2 Bolzen <i>2 bolts</i> <i>2 ergots</i>	4 Bolzen <i>4 bolts</i> <i>4 ergots</i>
H-B 6 KDB	10015000	●	
H-B 10 KDB	10047000		●
H-B 16 KDB	10087000		●
H-B 24 KDB	10118000		●

Schutzdeckel für Tüllengehäuse mit Bolzen
Protective cover for hood with bolts
Couvercle pour capot avec ergots

H-B 6-24

Artikel <i>part</i> <i>article</i>	Art.Nr. <i>part No.</i> <i>N° art.</i>	Längsbügel <i>single locking lever</i> <i>simple levier</i>	Querbügel <i>double locking lever</i> <i>double levier</i>
H-B 6 KDT	10016500	●	
H-B 10 KDT	10048500		●
H-B 16 KDT	10088500		●
H-B 24 KDT	10119500		●

Schutzdeckel für Tüllengehäuse mit Bügel
Protective cover for hood with lever
Couvercle pour capot avec levier

H-B 6-24

Artikel <i>part</i> <i>article</i>	Art.Nr. <i>part No.</i> <i>N° art.</i>	2 Bolzen <i>2 bolts</i> <i>2 ergots</i>	4 Bolzen <i>4 bolts</i> <i>4 ergots</i>
H-B 6 KDBP	10015100	●	
H-B 10 KDBP	10047100		●
H-B 16 KDBP	10087100		●
H-B 24 KDBP	10118100		●

Gehäuse / *Housings* / *Bottiers*: 3.2: H-B 6/10/16/24

5.2 EPIC® CODIX

Codierung / Coding / Codage

Bei mehreren nebeneinander montierten Steckverbindern ist eine Codierung zweckmäßig. So können Fehlsteckungen vermieden werden. Das dient sowohl Ihrem Schutz als auch dem Schutz der Anlage.

Coding is used when several connectors are mounted next to one another. This helps prevent incorrect connection, thus protecting you and the installation.

Lorsque plusieurs connecteurs multiples sont montés les uns à côté des autres, un codage est nécessaire. Les enfichages erronés peuvent alors être évités. Cela sert tout autant à votre protection qu'à celle de l'installation.



5.2 EPIC® C O D I X

Codierung / Coding / Codage



Codierung mit Sperrbolzen
Polarising with key-pin
Détrompage par vis de codage

Artikel <i>part</i> <i>article</i>	Art.Nr. <i>part No.</i> <i>N° art.</i>	Einsatz <i>insert</i> <i>insert</i>	VPE <i>packing unit</i> <i>conditionnement</i>
Codierbolzen / <i>key pin</i> / <i>vis de codage</i>	10019000	H-BE, H-BVE, H-A	50
Codierbolzen / <i>key pin</i> / <i>vis de codage</i>	10019200	H-D 15-128	50

Codierschema
Key positions
Schéma de codage

1 Einsatz / 1 insert / 1insert

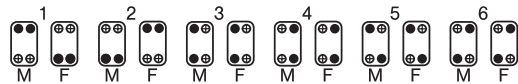

● **Codierbolzen**
Key pin
Vis de codage

⊕ **Befestigungsschraube**
Fixing screw
Vis de fixation

2 Einsätze / 1 inserts / 1inserts

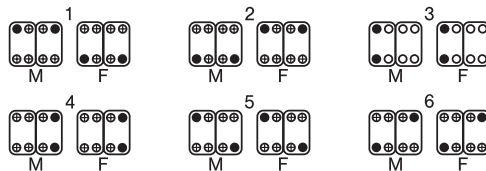

M = Stifteinsatz / *male insert* / *insert mâle*

F = Buchseneinsatz / *female insert* / *insert femelle*

5.2 EPIC® C O D I X

Codierung / Coding / Codage



Codierung mit Führungsstift und Führungsbuchse

Polarization system with guide pin and guide socket

Détrompage par broche et douille

Artikel <i>part</i> <i>article</i>	Art.Nr. <i>part No.</i> <i>N° art.</i>	Einsatz <i>insert</i> <i>insert</i>	VPE <i>packing unit</i> <i>conditionnement</i>
Führungsstift / <i>guide pin / broche</i>	11280000	H-D 15-128	50
Führungsbuchse / <i>guide socket / douille</i>	11281000	H-D 15-128	50

Für Anschlußart Crimp- / Schraub- / Käfigzugfeder

Termination crimp / screw / cage clamp

Raccordement à setir / à visser / lame de pression

Codierschema

Key positions

Schéma de codage

● Führungsstift

Guide pin

Broche

○ Führungsbuchse

Guide socket

Douille

⊕ Befestigungsschrauben

Fixing screw

Vis de fixation

1 Einsatz / 1 insert / 1insert

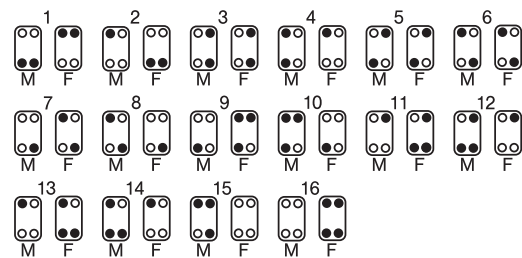

2 Einsätze / 1 inserts / 1inserts

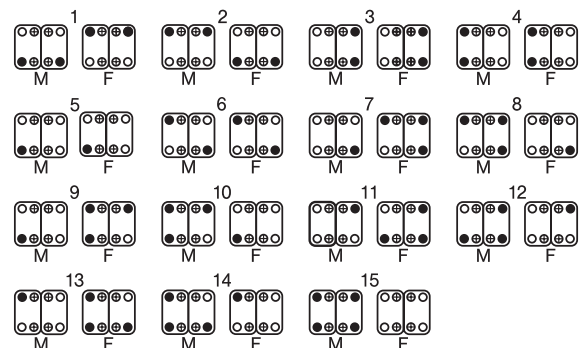

M = Stifteinsatz / *male insert / insert mâle*

F = Buchseneinsatz / *female insert / insert femelle*

5.2 EPIC® C O D I X

Codierung / Coding / Codage



Codierung mit Kontaktverlust *Polarization system with contact loss* *Détrompage à perte de contacts*

Artikel <i>part</i> <i>article</i>	Art.Nr. <i>part No.</i> <i>N° art.</i>	VPE <i>packing unit</i> <i>conditionnement</i>
Codierstift H-D 7/8 / <i>Coding pin H-D 7/8</i> / <i>Broche H-D 7/8</i>	11162000	100
Codierstift H-A 3/4 / <i>Coding pin H-A 3/4</i> / <i>Broche H-A 3/4</i>	10451200	50

Werkzeug *Tool* *Outillage*

Artikel <i>part</i> <i>article</i>	Art.Nr. <i>part No.</i> <i>N° art.</i>	VPE <i>packing unit</i> <i>conditionnement</i>
Ausdrückwerkzeug H-D 7/8 <i>Removal tool H-D 7/8</i> <i>Outil de demontage H-D 7/8</i>	11161200	1

5.3 EPIC® D A - V I N C I Perfect

Bügel / Levers / Leviers

Die Suche nach dem optimalen Bügelssystem hat mit der neuen Da-Vinci Bügelgeneration den krönenden Abschluß gefunden. Die Synthese aus Raumersparnis, Funktionalität und Stabilität. Da-Vinci Perfect ist abnehmbar, arretierbar, durch Kunststoffclip leicht zu kennzeichnen und das bei bester Ergonomie. Sie sparen Platz, denn mit dem Perfect haben Sie die geringsten Schwenkmaße bei garantierter Wettbewerbskompatibilität. Wir wollen Ihnen schließlich den Wechsel leicht machen.

The Da-Vinci new generation of locking levers represents the crowning glory in the search for the optimum connector locking system. The perfect combination of space-saving design, functionality and stability. Da-Vinci Perfect is removable, lockable, easy to identify using a plastic clip, and all combined with the best possible ergonomics. You will save space, since Perfect allows you the smallest possible pivoting dimensions with guaranteed competitor compatibility. Ultimately, our aim is to make the change easy for you.

La recherche d'un système d'étrier optimal vient enfin d'aboutir: la nouvelle génération d'étriers Da-Vinci est un achèvement brillant.

Une synthèse de faible encombrement, de fonctionnalité et de robustesse. Da-Vinci Perfect est amovible, verrouillable, facilement repérable par un clip plastique et le tout en parfaite ergonomie. Vous gagnez de la place, car le Perfect possède une des plus petites cotes de pivotement et la compatibilité avec la concurrence est néanmoins garantie. Nous voulons vous faciliter l'échange au maximum.



5.3 EPIC® DA - VINCI Perfect

Bügel / Levers / Leviers

Technische Daten

- Werkstoff:
 - Bügel:Stahl/Edelstahl
 - Bügelclip:Polyamid
 - Bezeichnungssystem für Bügel:Fleximark

Technical Data

- Material:
 - Lever:steel/stainless steel
 - Lever clip:Polyamide
 - Lever marking system:Fleximark

Caractéristiques techniques

- Matériau:
 - Levier:inox/acier inox
 - Clip levier:Polyamide
 - clip d'étiquetage:Fleximark

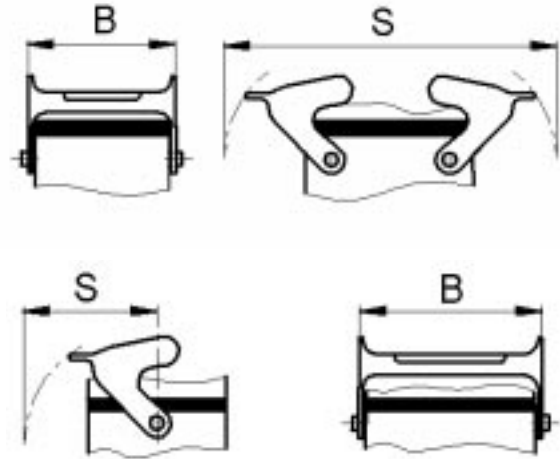

Baureihe	Schwenkmaß DA-VINCI Perfect	Schwenkmaß Wettbewerb	Schwenk- normmaß Standard	Breite DA-VINCI Perfect	Breite Wettbewerb
Series	<i>Pivoting dimension DA-VINCI Perfect</i>	<i>Competitors' pivoting dimension</i>	<i>Standard pivoting dimension</i>	<i>Width DA-VINCI Perfect</i>	<i>Competitors' width</i>
Série	<i>Cote de pivotement DA-VINCI Perfect</i>	<i>Cote de pivotement de la concurrence</i>	<i>Cote de pivotement normalisée</i>	<i>Largeur DA-VINCI Perfect</i>	<i>Largeur de la concurrence</i>
H-A 10 LB	36,5	36,5	40	71,4	75
H-A 16 LB	36,5	36,5	40	87,8	91
H-A 32 QB	124,5	126	-	66	69,5
H-A 48 QB	136,5	158	-	87,8	99
H-B 6 LB	44	46,5	60	70	73
H-B 10 LB	50	57,5	60	88,5	84
H-B 16 LB	50	57,5	60	109,5	104,5
H-B 24 LB	50	57,5	60	136,5	131
H-B 48 LB	105	90	-	139,5	147
H-B 10 QB	116	117	-	53	58
H-B 16 QB	136,5	137,5	145	53	58
H-B 24 QB	163	164	172	53	58
H-B 32 QB	136,5	158	-	87,8	99

5.3 EPIC® D A - V I N C I P e r f e c t

Bügel / *Levers* / *Leviers*



Längsbügel / *single locking lever* / *simple levier* H-B 6

Artikel / <i>part</i> / <i>article</i>	Art.Nr. / <i>part No.</i> / <i>N° art.</i>	Material / <i>material</i> / <i>matériau</i>
H-B 6 LB	10017000*	Stahl / <i>steel</i> / <i>acier</i>
H-B 6 LB-K	10017100*	Edelstahl / <i>stainless steel</i> / <i>inox</i>

Gehäuse / *Hoods* / *Boîtiers*: 3.2

Querbügel-Set / *double locking lever* / *double levier* H-B 10, H-B 16, H-B 24

Artikel / <i>part</i> / <i>article</i>	Art.Nr. / <i>part No.</i> / <i>N° art.</i>	Material / <i>material</i> / <i>matériau</i>
H-B 10-24 QB	10049000*	Stahl / <i>steel</i> / <i>acier</i>
H-B 10-24 QB-K	10049100*	Edelstahl / <i>stainless steel</i> / <i>inox</i>

Gehäuse / *Hoods* / *Boîtiers*: 3.2

5.3 EPIC® D A - V I N C I P e r f e c t

Bügel / *Levers* / *Leviers*



Längsbügel / *single locking lever* / *simple levier*

H-A 10

Artikel / <i>part</i> / <i>article</i>	Art.Nr. / <i>part No.</i> / <i>N° art.</i>	Material / <i>material</i> / <i>matériau</i>
H-A 10 LB	10458000*	Stahl / <i>steel</i> / <i>acier</i>
H-A 10 LB-K	10458100*	Edelstahl / <i>stainless steel</i> / <i>inox</i>

Gehäuse / *Hoods* / *Boîtiers*: 3.1

Längsbügel / *single locking lever* / *simple levier*

H-A 16

Artikel / <i>part</i> / <i>article</i>	Art.Nr. / <i>part No.</i> / <i>N° art.</i>	Material / <i>material</i> / <i>matériau</i>
H-A 16 LB	10468000*	Stahl / <i>steel</i> / <i>acier</i>
H-A 16 LB-K	10468100*	Edelstahl / <i>stainless steel</i> / <i>inox</i>

Gehäuse / *Hoods* / *Boîtiers*: 3.1

Metallbügel-Clip / *lever clip* / *clip levier*

H-A, H-B

Artikel / <i>part</i> / <i>article</i>	Art.Nr. / <i>part No.</i> / <i>N° art.</i>	Material / <i>material</i> / <i>matériau</i>
H-A/H-B Clip	10049500*	Plastik / <i>plastic</i> / <i>plastique</i>

Gehäuse / *Hoods* / *Boîtiers*: 3.1 / 3.2

5.4 EPIC® E L M A C

EMV-Schutz / EMC-protection / Protection CEM

Die perfekte Abschirmung gegenüber elektromagnetischen Störeinflüssen. Einfache Montage, kompatibel zu den Standardgehäusen. Besonders geeignet zum Nachrüsten, für Ihre Sicherheit.

The perfect shielding against electromagnetic interference. Simple to mount, compatible with standard housings. Particularly suitable for retrofitting, for your safety.

La protection parfaite contre les interférences électromagnétiques. Simple à monter, compatible avec les embases et boîtiers standard. Parfaitement adapté au montage ultérieur pour améliorer votre sécurité.



5.4 EPIC® E L M A C

EMV-Schutz / EMC-protection / Protection CEM

Technische Daten

- Nachrüstbar für: Rechtecksteckverbinder
Rundsteckverbinder

Technical Data

- Can be retrofitted to: Rectangular connectors
circular connectors

Caractéristiques techniques

- Adaptable sur: Connecteurs rectangulaires
Connecteurs circulaires

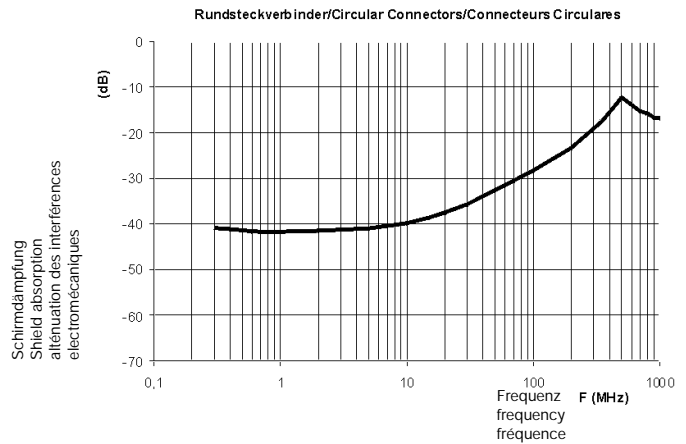
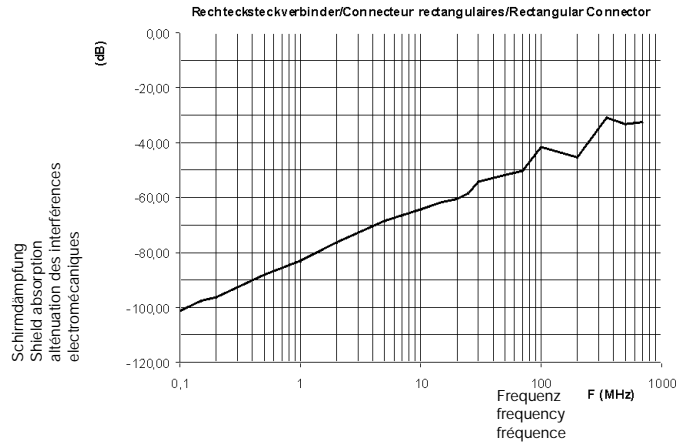

Montagevorgang / Directions for use / Instruction de montage

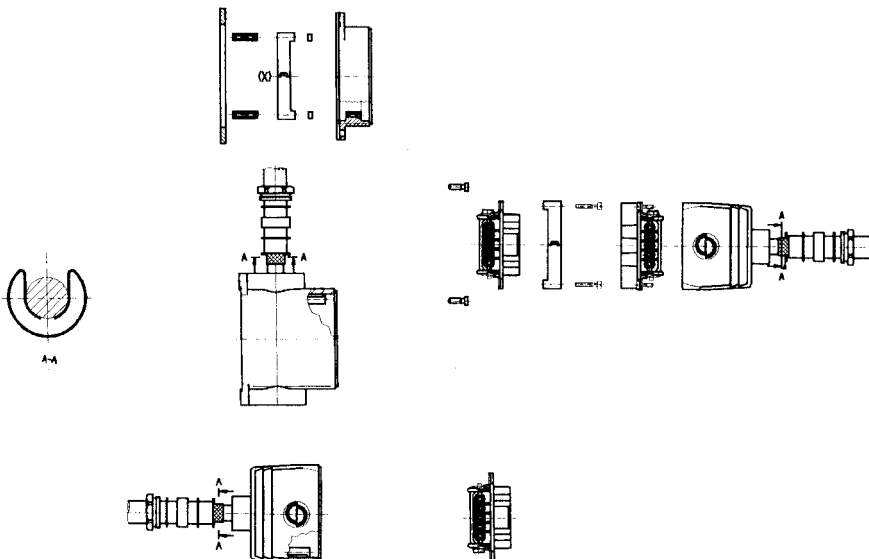

5.4 EPIC® E L M A C

EMV-Schutz / EMC-protection / Protection CEM



EMV-Schutz: Rechtecksteckverbinder
EPIC EMC protection: rectangular connectors
Protection CEM pour EPIC: Connecteurs rectangulaires

H-B: EMV-Kit Anbaugeschütz
H-B: EMC kit for panel mount base
H-B: Kit CEM pour embase encastrée

H-B 6

Artikel / part / article	Art.Nr. / part No. / N° art.
H-B 6 EMV-AG	70350000

Gehäuse / Hoods / Boitiers: 3.2

H-B 10

Artikel / part / article	Art.Nr. / part No. / N° art.
H-B 10 EMV-AG	70350100

Gehäuse / Hoods / Boitiers: 3.2

H-B 16

Artikel / part / article	Art.Nr. / part No. / N° art.
H-B 16 EMV-AG	70350200

Gehäuse / Hoods / Boitiers: 3.2

H-B 24

Artikel / part / article	Art.Nr. / part No. / N° art.
H-B 24 EMV-AG	70350300

Gehäuse / Hoods / Boitiers: 3.2

H-B: EMV-Kit Sockel- / Kupplungsgehäuse
H-B: EMC kit for surface mount base / cable connector hood
H-B: Kit CEM pour embase en saillie / capot prolongateur

H-B 6

Artikel / part / article	Art.Nr. / part No. / N° art.
H-B 6 EMV-SG/TBF	70352000

Gehäuse / Hoods / Boitiers: 3.2

5.4 EPIC® E L M A C

EMV-Schutz / EMC-protection / Protection CEM



EMV-Schutz: Rechtecksteckverbinder
EPIC EMC protection: rectangular connectors
Protection CEM pour EPIC: Connecteurs rectangulaires

H-B: EMV-Kit Sockel- / Kupplungsgehäuse
H-B: EMC kit for surface mount base / cable connector hood
H-B: Kit CEM pour embase en saillie / capot prolongateur

H-B 10

Artikel / part / article	Art.Nr. / part No. / N° art.
H-B 10 EMV-SG/TBF	70352100

Gehäuse / Hoods / Boîtiers: 3.2

H-B 16

Artikel / part / article	Art.Nr. / part No. / N° art.
H-B 16 EMV-SG/TBF	70352200

Gehäuse / Hoods / Boîtiers: 3.2

H-B 24

Artikel / part / article	Art.Nr. / part No. / N° art.
H-B 24 EMV-SG/TBF	70352300

Gehäuse / Hoods / Boîtiers: 3.2

H-A: EMV-Kit Anbaugehäuse
H-A: EMC kit for panel mount base
H-A: Kit CEM pour embase encastrée

H-A 10

Artikel / part / article	Art.Nr. / part No. / N° art.
H-A 10 EMV-AG	70700000

Gehäuse / Hoods / Boîtiers: 3.1

H-A 16

Artikel / part / article	Art.Nr. / part No. / N° art.
H-A 16 EMV-AG	70700100

Gehäuse / Hoods / Boîtiers: 3.1

5.4 EPIC® E L M A C

EMV-Schutz / EMC-protection / Protection CEM



EMV-Schutz: Rechtecksteckverbinder

EPIC EMC protection: rectangular connectors

Protection CEM pour EPIC: Connecteurs rectangulaires

H-A: EMV-Kit Sockel-/Kupplungsgehäuse

H-A: EMC kit for surface mount base / cable connector hood

H-A: Kit CEM pour embase en saillie / capot prolongateur

H-A 10

Artikel / part / article	Art.Nr. / part No. / N° art.
H-A 10 EMV-SG/TBF	70702000

Gehäuse / Hoods / Boitiers: 3.1

H-A 16

Artikel / part / article	Art.Nr. / part No. / N° art.
H-A 16 EMV-SG/TBF	70702100

Gehäuse / Hoods / Boitiers: 3.1



EMV-Schutz: Rundsteckverbinder & Rechtsteckverbinder

EMC protection: circular connectors & rectangular connectors

Protection CEM: Connecteurs circulaires & rectangulaires

Artikel part article	Art.Nr. part No. N° art.	für Rundsteckverbinder mit Anschlußgröße for circular connectors size pour connecteurs ronds modèle
SAE-7	75000000	PG 7
SAE-9	75000100	PG 9
SAE-11	75000200	PG 11
SAE-13,5	75000300	PG 13,5
SAE-16	75000400	PG 16

6.1 EPIC® CIRCON LS 1

Rundsteckverbinder / *Circular connector* / *Connecteur circulaire*

Rundsteckverbinder zur Leistungsübertragung z.B. an Motoren und Antrieben. Die neue Generation der EPIC® Rundsteckverbinder Serie LS1 ist wahlweise als bewährte Schraubversion oder als Push-Pull Variante erhältlich.

Bei der Installation der Serie LS1 Rundsteckverbinder kommen Crimp-Kontakte zum Einsatz, dies gewährleistet höchstmögliche Qualität des Anschlusses, bei gleichzeitiger Reduzierung der Installationskosten. Darüberhinaus bieten die neuen EPIC® Rundsteckverbinder durch eine 360° Schirmanbindung hervorragenden EMV-Schutz. Das neue Design der Kuppelungs-dosen erlaubt sowohl die Verwendung von Schraub- als auch von Push-Pull-Steckern, wobei die Steckkompatibilität zu allen gängigen Systemen erhalten bleibt.

Circular connector for power transmission e.g. for motors and driving gear. The new generation of EPIC® circular connectors, series LS1, is optionally available in the traditional screwing version or as a push-pull variant.

For the installation of the series LS1 (power) circular connectors, crimp contacts are used which guarantee the highest possible quality of the connection, reducing the installation costs at the same time. In addition, the new EPIC® circular connectors offer outstanding electromagnetic compatibility protection through a 360° screen connection. The new design of the coupling allows the use of both screw and push-pull connectors, while the compatibility is maintained for all systems normally used.

Connecteur circulaire pour la transmission de puissance p. ex. aux moteurs et aux entraînements.

La nouvelle génération des connecteurs circulaire EPIC® de la série LS1 peut être obtenue au choix en version vissable ou sous sa variante push-pull. Des contacts à sertir sont utilisés pour l'installation de connecteurs circulaire de la série LS 1 (puissane). Ceci garantit la meilleure qualité de connexion possible tout en réduisant les coûts d'installation. En outre, les nouveaux connecteurs circulaire EPIC® offrent une protection de compatibilité électromagnétique exceptionnelle grâce à un blindage à 360°. La nouvelle conception des prises permet aussi bien l'utilisation de connecteurs vissables que de connecteurs push-pull, la compatibilité à tous les systèmes courants étant maintenue.



6.1 EPIC® CIRCONLS 1

Rundsteckverbinder / Circular connector / Connecteur circulaire

Technische Daten:

- Polzahlen 5+ PE, 4+3+PE, 5+3+PE
- Verschmutzungsgrad 3
- Bemessungsspannung 250/800 V, AC
- Bemessungsstrom 9/30 A
- Prüfspannung: 2,5/6 kV, AC
- Temperaturbereich -40°C - +125°C
- Schutzart IP 67 gesteckt, DIN 40050
- Leitungsanschluß: Crimp 2 mm Kontakte: 0,5-2,5 mm / 2,5-4,0 mm² Leistung
1 mm Kontakte: 0,06-1,0 mm² Signal
- Durchgangswiderstand (mΩ) < 3
- Steckzyklen > 500
- Kabeldurchmesser 9-14 mm / 14-17 mm

Material

- Gehäuse Zinkdruckguß vernickelt
- Isolierkörper PBT nach UL 94 V-0
- Kontaktmaterial Kupferlegierung, vergoldet
- Dichtungen Viton / H-NBR
- Klemmring Messing vernickelt

Technical Data:

- Number of contact 5+ PE, 4+3+PE, 5+3+PE
- Pollution level 3
- Rated voltage 250/800 V, AC
- Rated current: 9/30 A
- Test voltage: 2,5/6 kV, AC
- Temperature range: -40°C - +125°C
- Protection class: IP67 mated, DIN 40 050
- Wire gauge Crimp 2 mm contacts: 0,5-2,5 mm / 2,5-4,0 mm² power
1 mm contacts: 0,06-1,0 mm² signal

- Contact resistance (mΩ) < 3
- Mating cycles > 500
- Cable diameter 9-14 mm / 14-17 mm

Material

- Housing Die cast zinc, nickel plated
- Insulation body PBT according to UL 94 V-0
- Gaskets Viton / H-NBR
- Contacts Copper alloy, gold plated

Caractéristiques techniques:

- Nombre de contacts 5+ PE, 4+3+PE, 5+3+PE
- Degré de pollution 3
- Tension nominale 250/800 V, AC
- Courant nominale: 9/30 A
- Tension d'essai: 2,5/6 kV, AC
- Gamme de température: -40°C - +125°C
- Degré de protection: IP67 embroché, DIN 40 050
- Raccordement à sertir 2 mm contacts: 0,5-2,5 mm / 2,5-4,0 mm² puissance
1 mm contacts: 0,06-1,0 mm² signal

- Résistance de passage (mΩ) < 3
- Cycles d'insertion > 500
- Diamètre câble 9-14 mm / 14-17 mm

Matière

- Boîtier Zinc moulé par injection, nickelé
- Isolant PBT suivant UL 94 V-0
- Joints Viton / H-NBR
- Contacts Alliage cuivre, doré

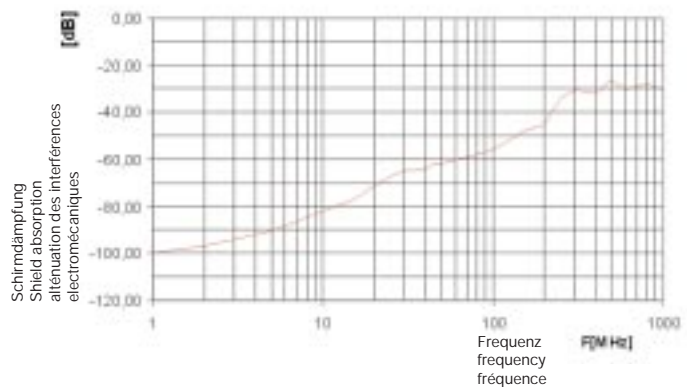
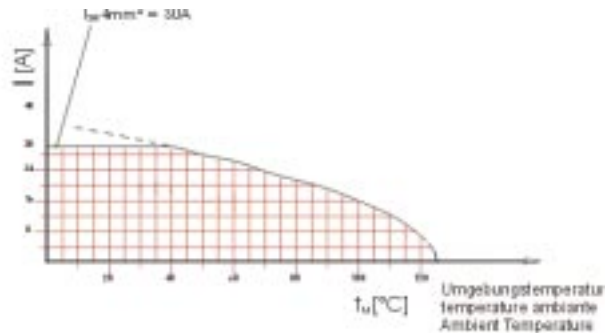

UL, CSA in Vorbereitung
UL, CSA under preparation
Préparation à UL, CSA



6.1 EPIC® C I R C O N L S 1

Rundsteckverbinder / *Circular connector* / *Connecteur circulaire*

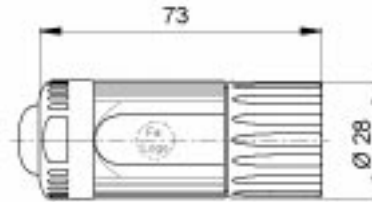

Bauform D6 (Stecker für Buchsenkontakte)

Style D6 (Connector for female contacts)

Modèle D6 (Connecteur pour contacts femelle)

Ansicht steckseitig
View from mating side
Vue côté de connection

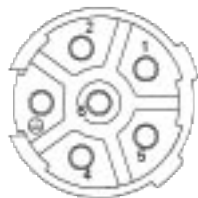

Artikel part article	Art.Nr. part No N° art.	Polbild poles pôles	Kabel-Ø cable-Ø cable-Ø	Kontakte contacts contacts	VPE packing unit conditionnement
LS1 D6 5+PE	76020000*	5+PE	9-14 mm	6 x 2 mm (0,5-2,5 mm)	5
LS1 D6 5+PE	76020010	5+PE	9-14 mm	6 x 2 mm (0,5-2,5 mm)	20
LS1 D6 5+PE	76020510	5+PE	9-14 mm	—————	20
LS1 D6 5+PE	76020710	5+PE	14-17 mm	—————	20

Ansicht steckseitig
View from mating side
Vue côté de connection



Artikel part article	Art.Nr. part No N° art.	Polbild poles pôles	Kabel-Ø cable-Ø cable-Ø	Kontakte contacts contacts	VPE packing unit conditionnement
LS1 D6 4+3+PE	76021000*	4+3+PE	9-14 mm	4 x 2 mm (0,5-2,5 mm) 4 x 1 mm (0,06-1,0 mm)	5
LS1 D6 4+3+PE	76021010	4+3+PE	9-14 mm	4 x 2 mm (0,5-2,5 mm) 4 x 1 mm (0,06-1,0 mm)	20
LS1 D6 4+3+PE	76021510	4+3+PE	9-14 mm	—————	20
LS1 D6 4+3+PE	76021710	4+3+PE	14-17 mm	—————	20

Ansicht steckseitig
View from mating side
Vue côté de connection



Artikel part article	Art.Nr. part No N° art.	Polbild poles pôles	Kabel-Ø cable-Ø cable-Ø	Kontakte contacts contacts	VPE packing unit conditionnement
LS1 D6 5+3+PE	76022000*	5+3+PE	9-14 mm	4 x 2 mm (0,5-2,5 mm) 5 x 1 mm (0,06-1,0 mm)	5
LS1 D6 5+3+PE	76022010	5+3+PE	9-14 mm	4 x 2 mm (0,5-2,5 mm) 5 x 1 mm (0,06-1,0 mm)	20
LS1 D6 5+3+PE	76022510	5+3+PE	9-14 mm	—————	20
LS1 D6 5+3+PE	76022710	5+3+PE	14-17 mm	—————	20

Bauform D6 auch als kurze Bauform erhältlich (64 mm)

Style D6 available in a short version (64 mm)

Modèle D6 est maintenant disponible petite (64 mm)

6.1 EPIC® C I R C O N L S 1

Rundsteckverbinder / Circular connector / Connecteur circulaire

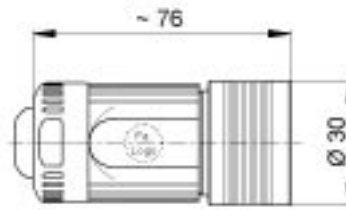

Bauform D8 (Stecker Push-Pull für Buchsenkontakte)

Style D8 (Connector Push-Pull for female contacts)

Modèle D8 (Connecteur Push-Pull pour contacts)

Ansicht steckseitig
View from mating side
Vue côté de connection



Artikel part article	Art.Nr. part No N° art.	Polbild poles pôles	Kabel-Ø cable-Ø cable-Ø	Kontakte contacts contacts	VPE packing unit conditionnement
LS1 D8 5+PE	76025000*	5+PE	9-14 mm	6 x 2 mm (0,5-2,5 mm)	5
LS1 D8 5+PE	76025010	5+PE	9-14 mm	6 x 2 mm (0,5-2,5 mm)	20
LS1 D8 5+PE	76025510	5+PE	9-14 mm	—————	20

Ansicht steckseitig
View from mating side
Vue côté de connection



Artikel part article	Art.Nr. part No N° art.	Polbild poles pôles	Kabel-Ø cable-Ø cable-Ø	Kontakte contacts contacts	VPE packing unit conditionnement
LS1 D8 4+3+PE	76026000*	4+3+PE	9-14 mm	4 x 2 mm (0,5-2,5 mm) 4 x 1 mm (0,06-1,0 mm)	5
LS1 D8 4+3+PE	76026010	4+3+PE	9-14 mm	4 x 2 mm (0,5-2,5 mm) 4 x 1 mm (0,06-1,0 mm)	20
LS1 D8 4+3+PE	76026510	4+3+PE	9-14 mm	—————	20

Ansicht steckseitig
View from mating side
Vue côté de connection



Artikel part article	Art.Nr. part No N° art.	Polbild poles pôles	Kabel-Ø cable-Ø cable-Ø	Kontakte contacts contacts	VPE packing unit conditionnement
LS1 D8 5+3+PE	76027000*	5+3+PE	9-14 mm	4 x 2 mm (0,5-2,5 mm) 5 x 1 mm (0,06-1,0 mm)	5
LS1 D8 5+3+PE	76027010	5+3+PE	9-14 mm	4 x 2 mm (0,5-2,5 mm) 5 x 1 mm (0,06-1,0 mm)	20
LS1 D8 4+3+PE	76027510	5+3+PE	9-14 mm	—————	20

6.1 EPIC® C I R C O N L S 1

Rundsteckverbinder / *Circular connector* / *Connecteur circulaire*

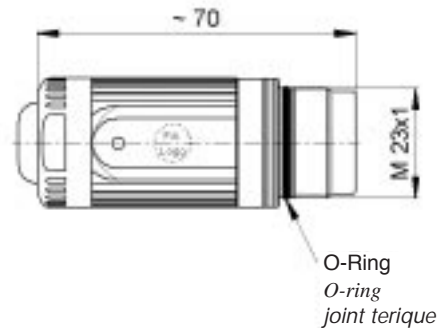

Bauform F6 (Kupplung für Stiftkontakte)
Style F6 (Coupling for male contacts)
Modèle F6 (Prolongateur pour contacts femelle)

Ansicht steckseitig
 View from mating side
 Vue côté de connection



Artikel <i>part article</i>	Art.Nr. <i>part No N° art.</i>	Polbild <i>poles pôles</i>	Kabel-Ø <i>cable-Ø cable-Ø</i>	Kontakte <i>contacts contacts</i>	VPE <i>packing unit conditionnement</i>
LS1 F6 5+PE	76030000*	5+PE	9-14 mm	6 x 2 mm (0,5-2,5 mm)	5
LS1 F6 5+PE	76030010	5+PE	9-14 mm	6 x 2 mm (0,5-2,5 mm)	20
LS1 F6 5+PE	76030510	5+PE	9-14 mm	—————	20
LS1 F6 5+PE	76030710	5+PE	14-17 mm	—————	20

Ansicht steckseitig
 View from mating side
 Vue côté de connection



Artikel <i>part article</i>	Art.Nr. <i>part No N° art.</i>	Polbild <i>poles pôles</i>	Kabel-Ø <i>cable-Ø cable-Ø</i>	Kontakte <i>contacts contacts</i>	VPE <i>packing unit conditionnement</i>
LS1 F6 4+3+PE	76031000*	4+3+PE	9-14 mm	4 x 2 mm (0,5-2,5 mm) 4 x 1 mm (0,06-1,0 mm)	5
LS1 F6 4+3+PE	76031010	4+3+PE	9-14 mm	4 x 2 mm (0,5-2,5 mm) 4 x 1 mm (0,06-1,0 mm)	20
LS1 F6 4+3+PE	76031510	4+3+PE	9-14 mm	—————	20
LS1 F6 4+3+PE	76031710	4+3+PE	14-17 mm	—————	20

Hinweis: Bei Verwendung mit Push-Pull Steckern der Bauform D8, muß der Vibrationsschutz/O-Ring vorher entfernt werden – dies hat jedoch keinen Einfluß auf die Dichtigkeitseigenschaften.

Note: For applications with push-pull D8 plug connectors, the vibration protection / o-ring must be removed. This does not have any effect on the sealing properties.

Remarque: Lors de l'emploi de connecteurs à "Push-Pull" de la forme de construction D8, la protection anti-vibrations / le joint torique doit tout d'abord être retiré - ceci n'influence cependant en rien les propriétés d'étanchéité.

6.1 EPIC® C I R C O N L S 1

Rundsteckverbinder / Circular connector / Connecteur circulaire

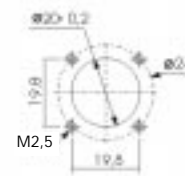
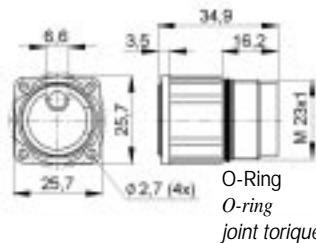

Montageausschnitt
Panel cut-out
Découpe de montage

Bauform A1 (Einbaudose für Stiftkontakte) Style A1 (Panel mount socket for male contacts) Modèle A1 (Prise encastrée droite pour contacts mâles)

Ansicht steckseitig
View from mating side
Vue côté de connection

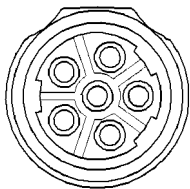

Artikel part article	Art.Nr. part No N° art.	Polbild poles pôles	Kontakte contacts contacts	VPE packing unit conditionnement
LS1 A1 5+PE	76000000*	5+PE	6 x 2 mm (0,5-2,5 mm)	5
LS1 A1 5+PE	76000010	5+PE	6 x 2 mm (0,5-2,5 mm)	20
LS1 A1 5+PE	76000510	5+PE	—————	20

Ansicht steckseitig
View from mating side
Vue côté de connection



Artikel part article	Art.Nr. part No N° art.	Polbild poles pôles	Kontakte contacts contacts	VPE packing unit conditionnement
LS1 A1 4+3+PE	76001000*	4+3+PE	4 x 2 mm (0,5-2,5 mm) 4 x 1 mm (0,06-1,0 mm)	5
LS1 A1 4+3+PE	76001010	4+3+PE	4 x 2 mm (0,5-2,5 mm) 4 x 1 mm (0,06-1,0 mm)	20
LS1 A1 4+3+PE	76001510	4+3+PE	—————	20

Ansicht steckseitig
View from mating side
Vue côté de connection



Artikel part article	Art.Nr. part No N° art.	Polbild poles pôles	Kontakte contacts contacts	VPE packing unit conditionnement
LS1 A1 5+3+PE	76002000*	5+3+PE	4 x 2 mm (0,5-2,5 mm) 4 x 1 mm (0,06-1,0 mm)	5
LS1 A1 5+3+PE	76002010	5+3+PE	4 x 2 mm (0,5-2,5 mm) 5 x 1 mm (0,06-1,0 mm)	20
LS1 A1 5+3+PE	76002510	5+3+PE	—————	20

Hinweis: Bei Verwendung mit Push-Pull Steckern der Bauform D8, muß der Vibrationsschutz/O-Ring vorher entfernt werden – dies hat jedoch keinen Einfluß auf die Dichtigkeitseigenschaften.

Note: For applications with push-pull D8 plug connectors, the vibration protection / o-ring must be removed. This does not have any effect on the sealing properties.

Remarque: Lors de l'emploi de connecteurs à "Push-Pull" de la forme de construction D8, la protection anti-vibrations / le joint torique doit tout d'abord être retiré - ceci n'influence cependant en rien les propriétés d'étanchéité.

6.1 EPIC® C I R C O N L S 1

Rundsteckverbinder / Circular connector / Connecteur circulaire

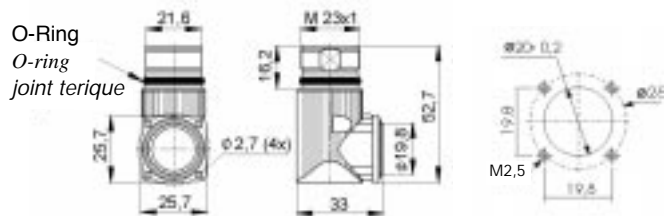

Montageausschnitt
Panel cut-out
Découpe de montage

Bauform A2 (Einbaudose gewinkelt 90° für Stiftkontakte)
Style A2 (Panel mount socket angled 90° for male contacts)
Modèle A2 (Prise encastrée angulaire 90° pour contacts mâle)

Ansicht steckseitig
View from mating side
Vue côté de connection

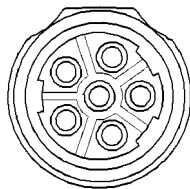

Artikel part article	Art.Nr. part No N° art.	Polbild poles pôles	Kontakte contacts contacts	VPE packing unit conditionnement
LS1 A2 5+PE	76010000*	5+PE	6 x 2 mm (0,5-2,5 mm)	5
LS1 A2 5+PE	76010010	5+PE	6 x 2 mm (0,5-2,5 mm)	20
LS1 A2 5+PE	76010510	5+PE	—————	20

Ansicht steckseitig
View from mating side
Vue côté de connection



Artikel part article	Art.Nr. part No N° art.	Polbild poles pôles	Kontakte contacts contacts	VPE packing unit conditionnement
LS1 A2 4+3+PE	76011000*	4+3+PE	4 x 2 mm (0,5-2,5 mm) 4 x 1 mm (0,06-1,0 mm)	5
LS1 A2 4+3+PE	76011010	4+3+PE	4 x 2 mm (0,5-2,5 mm) 4 x 1 mm (0,06-1,0 mm)	20
LS1 A2 4+3+PE	76011510	4+3+PE	—————	20

Ansicht steckseitig
View from mating side
Vue côté de connection



Artikel part article	Art.Nr. part No N° art.	Polbild poles pôles	Kontakte contacts contacts	VPE packing unit conditionnement
LS1 A2 5+3+PE	76012000*	5+3+PE	4 x 2 mm (0,5-2,5 mm) 4 x 1 mm (0,06-1,0 mm)	5
LS1 A2 5+3+PE	76012010	5+3+PE	4 x 2 mm (0,5-2,5 mm) 5 x 1 mm (0,06-1,0 mm)	20
LS1 A2 5+3+PE	76012510	5+3+PE	—————	20

Hinweis: Bei Verwendung mit Push-Pull Steckern der Bauform D8, muß der Vibrationsschutz/O-Ring vorher entfernt werden – dies hat jedoch keinen Einfluß auf die Dichtigkeitseigenschaften.

Note: For applications with push-pull D8 plug connectors, the vibration protection / o-ring must be removed. This does not have any effect on the sealing properties.

Remarque: Lors de l'emploi de connecteurs à "Push-Pull" de la forme de construction D8, la protection anti-vibrations / le joint torique doit tout d'abord être retiré - ceci n'influence cependant en rien les propriétés d'étanchéité.

6.1 EPIC® C I R C O N L S 1

Rundsteckverbinder / *Circular connector* / *Connecteur circulaire*



Kontakte Contacts Contacts

Artikel <i>part</i> <i>article</i>	Durchmesser <i>diameter</i> <i>diamètre</i>	Art.Nr. <i>part No.</i> <i>N° art.</i>	Version <i>version</i> <i>version</i>	Leiterquerschnitt <i>wire gauge</i> <i>section</i>	Anschlußart <i>termination</i> <i>raccordement</i>	Für Bauform <i>for model</i> <i>pour modèle</i>	VPE <i>packing unit</i> <i>conditionnement</i>
Stift / <i>male</i> / <i>mâle</i>	1 mm	74030001* 74030000		0,06 - 1,0 mm ²	Crimp / <i>crimp</i> / à sertir	A	10 100
Stift / <i>male</i> / <i>mâle</i>	2 mm	74031001* 74031000		0,5 - 2,5 mm ²	Crimp / <i>crimp</i> / à sertir	A	10 100
Stift / <i>male</i> / <i>mâle</i>	2 mm	74032101* 74032100		2,5 - 4,0 mm ²	Crimp / <i>crimp</i> / à sertir	A	10 100
Buchse / <i>female</i> / <i>femelle</i>	1 mm	74020601* 74020600*	Schlitz / <i>slot</i> / <i>fente</i>	0,06 - 1,0 mm ²	Crimp / <i>crimp</i> / à sertir	D	10 100
Buchse / <i>female</i> / <i>femelle</i>	1 mm	74020501* 74020500	Hyper boloid	0,06 - 1,0 mm ²	Crimp / <i>crimp</i> / à sertir	D	10 100
Buchse / <i>female</i> / <i>femelle</i>	2 mm	74031501* 74031500	Hyper boloid	0,5 - 4,0 mm ²	Crimp / <i>crimp</i> / à sertir	D	10 100
Buchse / <i>female</i> / <i>femelle</i>	2 mm	74032501* 74032500	Hyper boloid	2,5 - 4,0 mm ²	Crimp / <i>crimp</i> / à sertir	D	10 100
Stift / <i>male</i> / <i>mâle</i>	1 mm	74030101* 74030100		0,06 - 1,0 mm ²	Crimp / <i>crimp</i> / à sertir	F	10 100
Stift / <i>male</i> / <i>mâle</i>	2 mm	74031101* 74031100		0,5 - 2,5 mm ²	Crimp / <i>crimp</i> / à sertir	F	10 100
Stift / <i>male</i> / <i>mâle</i>	2 mm	74032001* 74032000		2,5 - 4,0 mm ²	Crimp / <i>crimp</i> / à sertir	F	10 100

6.1 EPIC® C I R C O N L S 1

Rundsteckverbinder / Circular connector / Connecteur circulaire



Zubehör Accessories Accessoires

Artikel part article	Art.Nr. part No. N° art.	Für Bauform for model pour modèle			F6	A1	A2	VPE packing unit conditionnement
		D6	D8					
Hutstopfen Cap plug Bouchon	75006010*				●	●	●	20
Klemmring Metall Clamp ring metal Anneau métallique	75006610	●	●	●				20
Kabelklemme Cable clamp ring Joint de filetage Ø 9 - 14 mm	75006910	●	●	●				20
Schirmelement Shield ring Anneau protection	75002110	●	●	●				20
° Adapter PG 16 Adapter PG 16 Adaptateur PG 16	75006410	●	●	●				20
Flansch Metall mit Dichtung Flange metal with seal Bride métallique avec joints	75006310	●	●	●				20
Kabelklemme Cable clamp ring Joint de filetage Ø 14 - 17 mm	75007210	●	●	●				20

° Hinweis: Adapter PG 16: Schutzart abhängig von Kabelverschraubung (4.1)

° Note: Adapter PG 16: Protection class dependant on cable gland (4.1)

° Remarque: Adaptateur PG 16: Degré de pollution dépendant de presse-étoupe (4.1)

6.1 EPIC® C I R C O N L S 1

Rundsteckverbinder / Circular connector / Connecteur circulaire

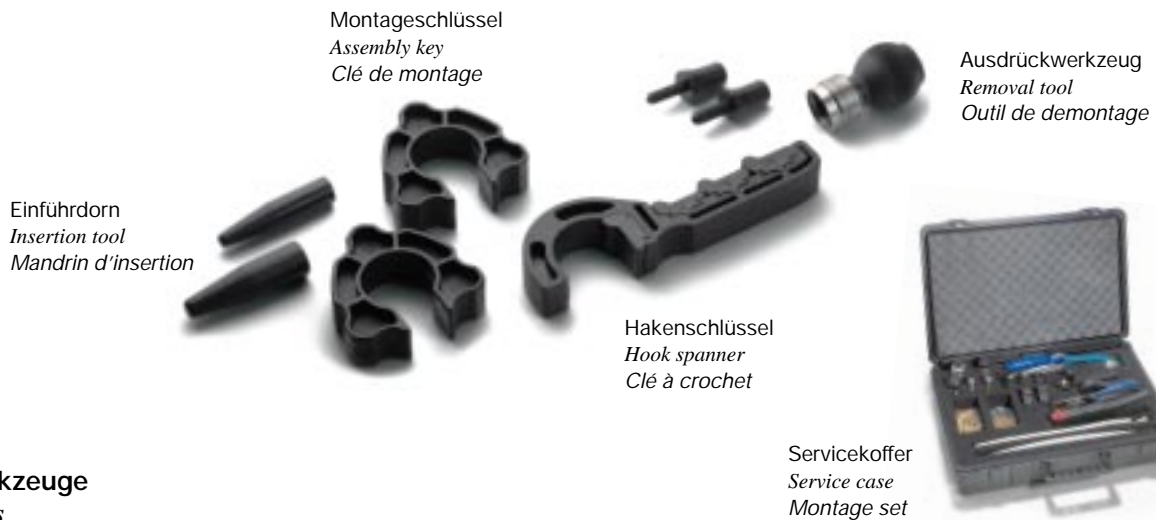

Werkzeuge Tools Outillage

Artikel part article	Art.Nr. part No. N° art.	VPE packing unit conditionnement
Tool-Set LS1/R2.5: 2x Einführdorn / Insertion tool / Mandrin d'insertion (1x LS 1 + 1x R2.5) 2x Montageschlüssel / Assembly key / Clé de montage (SW23/26) 1x Hakenschlüssel / Hook spanner / Clé à crochet 1x Ausbauwerkzeug Isolierkörper / Removal tool insulation body / Outil de demontage isolant (A1, A2), (R2.5) 1x Ausdrückwerkzeug 1mm Kontakte / Removal tool 1mm contact / Outil de demontage 1mm contacts (Bauform / model / modèle A1, A2), (LS1) 1x Ausdrückwerkzeug 2mm Kontakte / Removal tool 2mm contact / Outil de demontage 2mm contacts (Bauform / model / modèle A1, A2), (LS1)	75001000*	1
°° Crimpzange / Crimping tool small / Pince à sertir petite 0,06 - 1,0 mm ² (1mm Kontakte / contacts / contacts)	75008000*	1
° Crimpzange groß / Crimping tool large / Pince à sertir grande 0,34 - 4,0 mm ² (1mm, 2mm Kontakte / contacts / contacts)	75008100*	1
Locator für Crimpzange groß / Locator for crimping tool large / Centreur pour pince à sertir grande 1mm Kontakte / contacts / contacts	75008600*	1
Locator für Crimpzange groß / Locator for crimping tool large / Centreur pour pince à sertir grande 2mm Kontakte Typ A/D / contacts / contacts	75008700*	1
Locator für Crimpzange groß / Locator for crimping tool large / Centreur pour pince à sertir grande 1mm / 2mm Kontakte Typ F / contacts / contacts	75008800*	1
Ersatz-Positionierer für Crimpzange klein / Spare positioner for crimping tool small / Centreur replacement pour pince à sertir petite	75008400*	1
Ersatz-Positionierer für Crimpzange groß / Spare positioner for crimping tool large / Centreur replacement pour pince à sertir grande	75008500*	1
Servicekoffer für Rundsteckverbinder / Service case for circular connectors / Montage set pour connecteurs circulaires	75010000	1

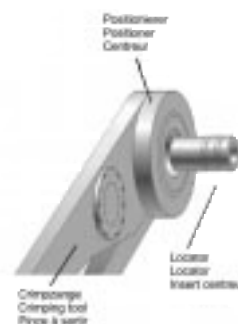

° Hinweis: inclusive Positionierer

°° inclusive Positionierer und Locator

° Note: Positioner included

°° Positioner and locator included

° Remarque: avec centreur

°° avec centreur at insert centreur

6.2 EPIC® C I R C O N R 2.5

Rundsteckverbinder / *Circular connector* / *Connecteur circulaire*

Rundsteckverbinder zur Signalübertragung z.B. an Knotenpunkten bei BUS-Systemen und Steuerungen. Die neue Generation der EPIC® Rundsteckverbinder Serie R2.5 ist wahlweise als bewährte Schraubversion oder als Push-Pull Variante erhältlich.

Bei den Rundsteckverbindern der Serie R2.5 (Signal) wird ein patentierter Isolierkörper verwendet, welcher zu allen Gehäuseformen paßt und sowohl Stift- als auch Buchsenkontakte aufnehmen kann. Dies ist bei allen Anschlußvarianten (Handlöt, Einlöt und Crimp) möglich. Die Lagerhaltung wird vereinfacht und dadurch Kosten gespart.

Circular connector for signal transmission e.g. for junctions for BUS-systems and for controls. The new generation of EPIC® circular connectors series R2.5 is optionally available in the traditional screwing version or as a push-pull variant.

In the case of circular connectors from the series R2.5 (signal), a patented insulation body is used which fits all housing designs, and can take both pin and socket contacts in all termination variants (solder, soldercup and crimping). This simplifies stock-keeping and consequently also saves costs.

Connecteurs circulaire pour la transmission de signaux p. ex. aux points nodaux de systèmes BUS et de commandes

La nouvelle génération des connecteurs circulaire EPIC® de la série R2.5 peut être obtenue au choix en version éprouvée vissable ou sous sa variante push-pull.

Un porte-contacts breveté est utilisé avec les connecteurs circulaire de la série R2.5 (signal). Ce isolant est adapté à toutes les formes de boîtier et accepte aussi bien les contacts mâles que les contacts femelles et ceci quelles que soient les variantes de raccordement (soudure manuelle, soudure et sertissage). Ceci facilite le stockage et permet ainsi une économie au niveau des coûts.



6.2 EPIC® C I R C O N R 2.5

Rundsteckverbinder / Circular connector / Connecteur circulaire

Technische Daten:

• Polzahlen	8+1	9	12	17
• Bemessungsspannung (V) AC	160	160	100 (löt) 160 (crimp)	40 (löt) 125 (crimp)
• Prüfspannung: (kV) AC	2,5	2,5	1,5 (löt) 2,5 (crimp)	1,5
• Verschmutzungsgrad	3			
• Bemessungsstrom: (A)	9 (1mm Kontakte) 25 (2mm Kontakte)			
• Temperaturbereich:	-40°C - +125°C			
• Schutzart:	IP67 gesteckt, DIN 40050			
• Leitungsanschluß:	Crimp: Kontakt 1mm 0,06-1,0 mm ² Kontakt 2mm 0,5-2,5 mm ² Löt bis 2,5 mm ² Einlöt Ø 1mm; 7,5mm lang			
• Durchgangswiderstand (mΩ)	< 5			
• Steckzyklen	> 500			

Material

• Gehäuse	Zinkdruckguß vernickelt
• Isolierkörper	PBT nach UL 94 V-0
• Dichtungen	Viton / H-NBR
• Klemmring	PA 6,6
• Kontakte	Kupferlegierung, vergoldet

Technical Data:

• Number of contact	8+1	9	12	17
• Rated voltage (V) AC	160	160	100 (solder) 160 (crimp)	40 (solder) 125 (crimp)
• Test voltage: (kV) AC	2,5	2,5	1,5 (solder) 2,5 (crimp)	1,5
• Pollution level	3			
• Rated current: (A)	9 (1mm contacts) 25 (2mm contacts)			
• Temperature range:	-40°C - +125°C			
• Protection class:	IP67 mated, DIN 40050			
• Wire gauge	Crimp: contact 1 mm 0,06 - 1,0 mm ² contact 2 mm 0,5 - 2,5 mm ² Solder 2,5 mm ² Solder pin Ø 1mm; 7,5mm length			
• Contact resistance (mΩ)	< 5			
• Mating cycles	> 500			

Material

• Housing	Die cast zinc, nickel plated
• Insulation body	PBT according to UL 94 V-0
• Gaskets	Viton / H-NBR
• Clamp ring	PA 6,6
• Contacts	Copper alloy, gold plated

Caractéristiques techniques:

• Nombre de contacts	8+1	9	12	17
• Tension nominale (V) AC	160	160	100 (à souder) 160 (à sertir)	40 (à souder) 125 (à sertir)
• Tension d'essai: (kV) AC	2,5	2,5	1,5 (à souder) 2,5 (à sertir)	1,5
• Degré de pollution	3			
• Courant nominale: (A)	9 (1mm contacts) 25 (2mm contacts)			
• Gamme de température:	-40°C - +125°C			
• Degré de protection:	IP67 embroché, DIN 40050			
• Raccordement	à sertir: contact 1mm 0,06-1,0 mm ² contact 2mm 0,5-2,5 mm ² à souder 2,5 mm ² à souder sur ci Ø 1mm; 7,5mm longueur			
• Résistance de passage (mΩ)	< 5			
• Cycles d'insertion	> 500			

Matière

• Boîtier	Zinc moulé par injection, nickelé
• Isolant	PBT suivant UL 94 V-0
• Joints	Viton / H-NBR
• Anneau plastique	PA 6,6
• Contacts	Alliage cuivre, doré

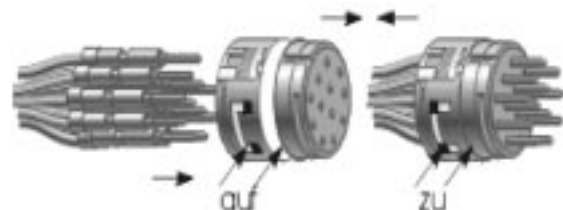
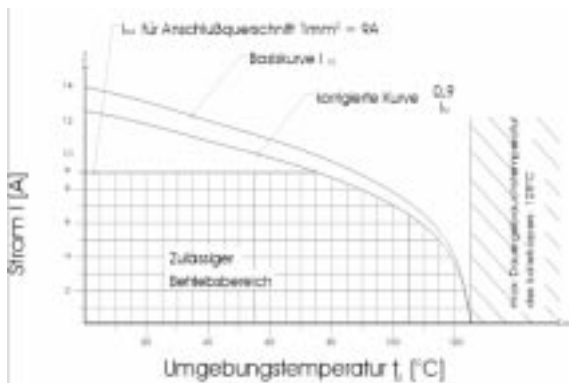

UL, CSA in Vorbereitung
UL, CSA under preparation
Préparation à UL, CSA

6.2 EPIC® C I R C O N R 2.5

Rundsteckverbinder / Circular connector / Connecteur circulaire



Bauform D6 Stecker / Style D6 Connector / Modèle D6 Connecteur

Artikel <i>part article</i>	Art.Nr. <i>part No. N° art.</i>	Kunststoffklemmring <i>clamp ring plastic anneau plastique</i>	Metallklemmring <i>clamp ring metal anneau métallique</i>	Kabel-Ø <i>cable-Ø câble-Ø</i>	VPE <i>packing unit conditionnement</i>
R2.5 D6 5,5-10,5	7204 0000*	●		5,5-10,5 mm	5
R2.5 D6 5,5-10,5	7204 0010	●		5,5-10,5 mm	20
R2.5 D6 9-12	7204 0100*	●		9-12 mm	5
R2.5 D6 9-12	7204 0110	●		9-12 mm	20
R2.5 D6 5,5-10,5	7204 1000*		●	5,5-10,5 mm	5
R2.5 D6 5,5-10,5	7204 1010		●	5,5-10,5 mm	20
R2.5 D6 9-12	7204 1100*		●	9-12 mm	5
R2.5 D6 9-12	7204 1110		●	9-12 mm	20



Bauform D8 Stecker Push-Pull Stecker

Style D8 Connector Push-Pull Connector

Modèle D8 Connecteur Push-Pull

Artikel <i>part article</i>	Art.Nr. <i>part No. N° art.</i>	Kunststoffklemmring <i>clamp ring plastic anneau plastique</i>	Metallklemmring <i>clamp ring metal anneau métallique</i>	Kabel-Ø <i>cable-Ø câble-Ø</i>	VPE <i>packing unit conditionnement</i>
R2.5 D8 5,5-10,5	7204 5000*	●		5,5-10,5 mm	5
R2.5 D8 5,5-10,5	7204 5010	●		5,5-10,5 mm	20
R2.5 D8 9-12	7204 5100*	●		9-12 mm	5
R2.5 D8 9-12	7204 5110	●		9-12 mm	20
R2.5 D8 5,5-10,5	7204 6000*		●	5,5-10,5 mm	5
R2.5 D8 5,5-10,5	7204 6010		●	5,5-10,5 mm	20
R2.5 D8 9-12	7204 6100*		●	9-12 mm	5
R2.5 D8 9-12	7204 6110		●	9-12 mm	20

6.2 EPIC® C I R C O N R 2.5

Rundsteckverbinder / Circular connector / Connecteur circulaire



Bauform D7 (Stecker gewinkelt) / Style D7 (Connector angled) / Modèle D7 (Connecteur 90°)

Artikel part article	Art.Nr. part No. N° art.	Kunststoffklemmring clamp ring plastic anneau plastique	Metallklemmring clamp ring metal anneau métallique	Kabel-Ø cable-Ø câble-Ø	VPE packing unit conditionnement
R2.5 D7 5,5-10,5	7205 0000*	●		5,5-10,5 mm	5
R2.5 D7 5,5-10,5	7205 0010	●		5,5-10,5 mm	20
R2.5 D7 9-12	7205 0100*	●		9-12 mm	5
R2.5 D7 9-12	7205 0110	●		9-12 mm	20
R2.5 D7 5,5-10,5	7205 0500*		●	5,5-10,5 mm	5
R2.5 D7 5,5-10,5	7205 0510		●	5,5-10,5 mm	20
R2.5 D7 9-12	7205 0600*		●	9-12 mm	5
R2.5 D7 9-12	7205 0610		●	9-12 mm	20



Bauform F6 Kupplung / Style F6 Coupling / Modèle F6 Prolongateur

Artikel part article	Art.Nr. part No. N° art.	Kunststoffklemmring clamp ring plastic anneau plastique	Metallklemmring clamp ring metal anneau métallique	Kabel-Ø cable-Ø câble-Ø	VPE packing unit conditionnement
R2.5 F6 5,5-10,5	7206 0000*	●		5,5-10,5 mm	5
R2.5 F6 5,5-10,5	7206 0010	●		5,5-10,5 mm	20
R2.5 F6 9-12	7206 0100*	●		9-12 mm	5
R2.5 F6 9-12	7206 0110	●		9-12 mm	20
R2.5 F6 5,5-10,5	7206 1000*		●	5,5-10,5 mm	5
R2.5 F6 5,5-10,5	7206 1010		●	5,5-10,5 mm	20
R2.5 F6 9-12	7206 1100*		●	9-12 mm	5
R2.5 F6 9-12	7206 1110		●	9-12 mm	20

Hinweis: Bei Verwendung mit Push-Pull Steckern der Bauform D8, muß der Vibrationsschutz/O-Ring vorher entfernt werden – dies hat jedoch keinen Einfluß auf die Dichtigkeitseigenschaften.

Note: For applications with push-pull D8 plug connectors, the vibration protection / o-ring must be removed. This does not have any effect on the sealing properties.

Remarque: Lors de l'emploi de connecteurs à "Push-Pull" de la forme de construction D8, la protection anti-vibrations / le joint torique doit tout d'abord être retiré - ceci n'influence cependant en rien les propriétés d'étanchéité.

6.2 EPIC® C I R C O N R 2.5

Rundsteckverbinder / *Circular connector* / *Connecteur circulaire*

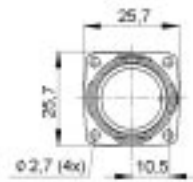

O-Ring
O-ring
joint torique

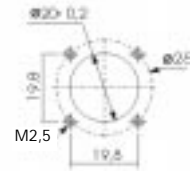

Montageausschnitt
Panel cut-out
Découpe de montage

Bauform A1 Einbaudose / *Style A1 Panel mount socket* / *Modèle A1 Prise encastrée*

Artikel <i>part</i> <i>article</i>	Art.Nr. <i>part No.</i> <i>N° art.</i>	VPE <i>packing unit</i> <i>conditionnement</i>
R2.5 A1	7200 0000*	5
R2.5 A1	7200 0010	20

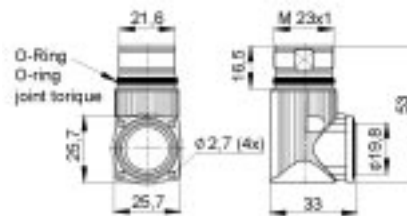

O-Ring
O-ring
joint torique

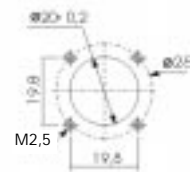

Montageausschnitt
Panel cut-out
Découpe de montage

Bauform A2 Einbaudose (90°) / *Style A2 Panel mount socket (90°)* / *Modèle A2 Prise encastrée (90°)*

Artikel <i>part</i> <i>article</i>	Art.Nr. <i>part No.</i> <i>N° art.</i>	VPE <i>packing unit</i> <i>conditionnement</i>
R2.5 A2	7202 0000*	5
R2.5 A2	7202 0010	20

Hinweis: Bei Verwendung mit Push-Pull Steckern der Bauform D8, muß der Vibrationsschutz/O-Ring vorher entfernt werden – dies hat jedoch keinen Einfluß auf die Dichtigkeitseigenschaften.

Note: For applications with push-pull D8 plug connectors, the vibration protection / o-ring must be removed. This does not have any effect on the sealing properties.

Remarque: Lors de l'emploi de connecteurs à "Push-Pull" de la forme de construction D8, la protection anti-vibrations / le joint torique doit tout d'abord être retiré - ceci n'influence cependant en rien les propriétés d'étanchéité.

6.2 EPIC® C I R C O N R 2.5

Rundsteckverbinder / Circular connector / Connecteur circulaire

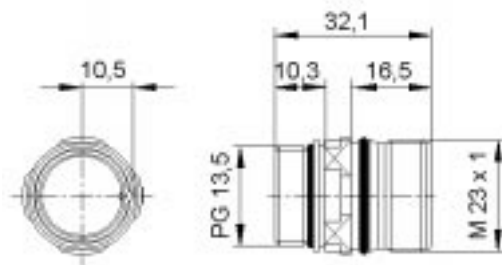

Bauform G4 Einbaudose PG 13,5

Style G4 Panel mount socket PG 13,5

Modèle G4 Prise encastrée PG 13,5

Artikel part article	Art.Nr. part No. N° art.	VPE packing unit conditionnement
R2.5 G4	7201 0000*	5
R2.5 G4	7201 0010	20

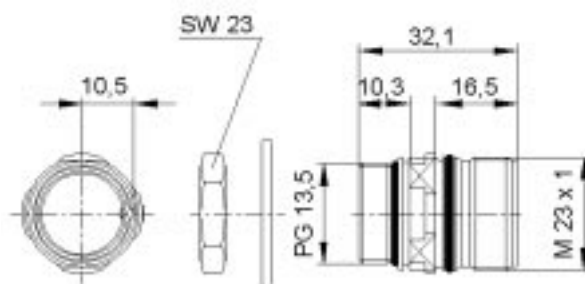

Bauform G5 Einbaudose PG 13,5 mit Kontermutter

Style G5 Panel mount socket PG 13,5 with locking nut

Modèle G5 Prise encastrée PG 13,5 avec écrou

Artikel part article	Art.Nr. part No. N° art.	VPE packing unit conditionnement
R2.5 G5	7211 0000*	5
R2.5 G5	7211 0010	20

Hinweis: Bei Verwendung mit Push-Pull Steckern der Bauform D8, muß der Vibrationsschutz/O-Ring vorher entfernt werden – dies hat jedoch keinen Einfluß auf die Dichtigkeitseigenschaften.

Note: For applications with push-pull D8 plug connectors, the vibration protection / o-ring must be removed. This does not have any effect on the sealing properties.

Remarque: Lors de l'emploi de connecteurs à "Push-Pull" de la forme de construction D8, la protection anti-vibrations / le joint torique doit tout d'abord être retiré - ceci n'influence cependant en rien les propriétés d'étanchéité.



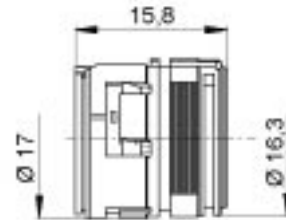

6.2 EPIC® C I R C O N R 2.5





Rundsteckverbinder / *Circular connector* / *Connecteur circulaire*



Isolierkörper / *Insulation body* / *Isolant*

Ansicht steckseitig <i>view from mating side</i> <i>vue côté de connection</i>	Kontakte <i>contacts</i> <i>contacts</i>	Isolierkörper unbestückt <i>insulation body +</i> <i>without contacts</i> <i>isolant</i> <i>sans contacts</i>	Isolierkörper + Stiftkontakte löt <i>insulation body</i> <i>male contacts solder</i> <i>isolant + contacts</i> <i>mâle à souder</i>	Isolierkörper + Buchsenkontakte löt <i>insulation body +</i> <i>female contacts solder</i> <i>isolant + contacts</i> <i>femelle à souder</i>	Kontakte 1 mm <i>contacts</i> <i>1mm</i> <i>contacts</i> <i>1 mm</i>	Kontakte 2 mm <i>contacts</i> <i>2 mm</i> <i>contacts</i> <i>2 mm</i>	VPE <i>packing unit</i> <i>conditionnement</i>
--	--	--	--	---	---	--	--

P-Teil / <i>P-Part</i> / <i>P-Pièce</i> Linksdrehend / <i>turning anti-clockwise</i> / <i>rotation à gauche</i>		8+1		73022100	73012100*	8	1	5
			8+1	73002110*	73022110	73012110	8	1
		9		73023100	73013100*	9	-	5
		9	73003110*	73023110	73013110	9	-	20
		12		73024100	73014100*	12	-	5
		12	73004110*	73024110	73014110	12	-	20
		17		73026100	73016100*	17	-	5
		17	73006110*	73026110	73016110*	17	-	20

E-Teil / <i>E-Part</i> / <i>E-Pièce</i> Rechtsdrehend / <i>turning clockwise</i> / <i>rotation à droite</i>		8+1		73022600*	73012600	8	1	5
			8+1	73002610*	73022610	73012610	8	1
		9		73023600*	73013600	9	-	5
		9	73003610*	73023610	73013610	9	-	20
		12		73024600*	73014600	12	-	5
		12	73004610*	73024610	73014610	12	-	20
		17		73026600*	73016600	17	-	5
		17	73006610*	73026610	73016610	17	-	20

Hinweis: Isolierkörper sind sowohl für Stift- als auch für Buchsenkontakte geeignet (P-Teil + E-Teil für eine Verbindung verwenden)

Note: *Insulation bodies are suitable for male and female contacts (use P-Part + E-Part for one connection)*

Remarque: *Isolants sont propre à contacts mâle et femelle (Utilisez P-Pièce + E-Pièce pour un assemblage)*

6.2 EPIC® C I R C O N R 2.5

Rundsteckverbinder / Circular connector / Connecteur circulaire



Kontakte / Contacts / Contacts

Artikel <i>part article</i>	Durchmesser <i>diameter diamètre</i>	Art.Nr. <i>part No. N° art.</i>	Version <i>type type</i>	Anschlußquerschnitt <i>wire gauge section</i>	Anschlußart <i>termination raccordement</i>	VPE <i>packing unit conditionnement</i>
Stift / male / mâle	1 mm	74020000*		0,06 - 1,0 mm ²	Crimp / crimp / à sertir	100
Stift / male / mâle	1 mm	74022000*			Löt / solder / à souder	100
Stift / male / mâle	1 mm	74024000*			Einlöt / PCB solder / à souder sur ci	100
Stift / male / mâle	2 mm	74021000*		0,5 - 2,5 mm ²	Crimp / crimp / à sertir	100
Stift / male / mâle	2 mm	74023000*			Löt / solder / à souder	100
Buchse / <i>female / femelle</i>	1 mm	74020600*	Schlitz / <i>slot / fente</i>	0,06 - 1,0 mm ²	Crimp / crimp / à sertir	100
Buchse / <i>female / femelle</i>	1 mm	74020500*	Hyper boloid		Crimp / crimp / à sertir	100
Buchse / <i>female / femelle</i>	1 mm	74022600*	Schlitz / <i>slot / fente</i>		Löt / solder / à souder	100
Buchse / <i>female / femelle</i>	1 mm	74022500*	Hyper boloid		Löt / solder / à souder	100
Buchse / <i>female / femelle</i>	2 mm	74021600*	Schlitz / <i>slot / fente</i>	0,5 - 2,5 mm ²	Crimp / crimp / à sertir	100

6.2 EPIC® C I R C O N R 2.5

Rundsteckverbinder / Circular connector / Connecteur circulaire

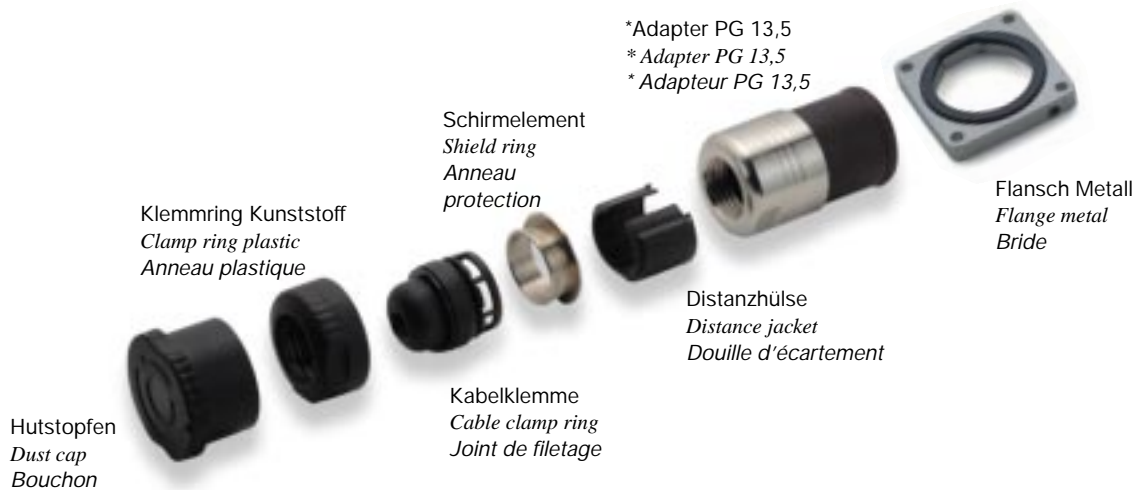

Baureihe R2.5: Zubehör und Ersatzteile

Accessories

Accessoires

Artikel part article	Art.Nr. part No. N° art.	Für Bauform for model pour modèle										VPE packing unit conditionnement
		D6	D7	D8	F6	A1	A2	G4	G5			
Hutstopfen Dust cap Bouchon	75006010*				●	●	●	●	●			20
Klemmring Kunststoff Clamp ring plastic Anneau plastique	75006510*	●	●	●	●							20
Klemmring Metall Clamp ring metal Anneau metallique	75005910*	●	●	●	●							20
Kabelklemme Cable clamp ring Joint de filetage Ø 5,5-10,5 mm	75006710*	●	●	●	●							20
Kabelklemme Cable clamp ring Joint de filetage Ø 9-12 mm	75006810*	●	●	●	●							20
Schirmring Shield ring Anneau protection	75002010*	●	●	●	●							20
Distanzhülse Distance Douille d'écartement	75004010*	●	●	●								20
° Adapter PG 13,5 Adapter PG 13,5 Adapteur PG 13,5	75006110*	●	●	●								20
Flansch Metall mit Dichtung Flange metal with seal Bride metallique avec joints	75006210	●	●	●	●							20

° Hinweis: Adapter 13,5: Schutzartabhängig von Kabelverschraubung (4.1)

° Note: Adapter PG 13,5: Protection class dependant on cable gland (4.1)

° Remarque: Adapteur PG 13,5: Degré de pollution dépendant de presse-étoupe (4.1)

6.2 EPIC® C I R C O N R 2.5

Rundsteckverbinder / Circular connector / Connecteur circulaire

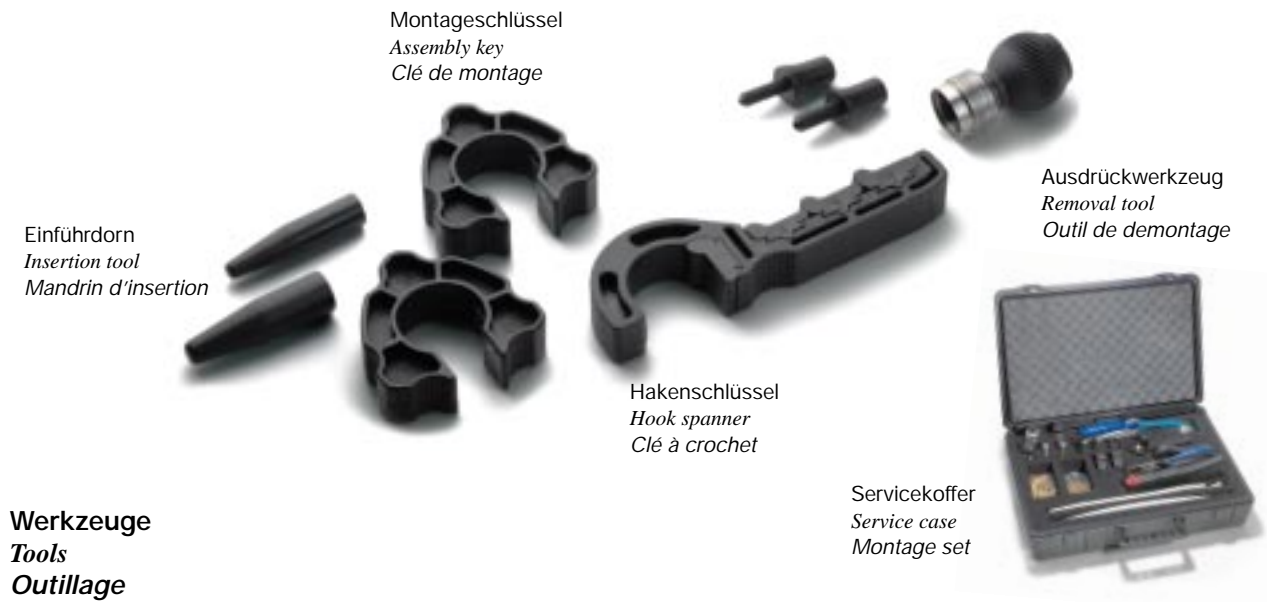

Artikel part article	Art.Nr. part No. N° art.	VPE packing unit conditionnement
Tool-Set LS1/R2.5: 2x Einführdorn / Insertion tool / Mandrin d'insertion (1x R2.5 + 1x LS 1) 2x Montageschlüssel / Assembly key / Clé de montage (SW23/26) 1x Hakenschlüssel / Hook spanner / Clé à crochet 1x Ausbauwerkzeug Isolierkörper / Removal tool insulation body / Outil de demontage isolant (A1, A2), (R2.5) 1x Ausdrückwerkzeug 1mm Kontakte / Removal tool 1mm contact / Outil de demontage 1mm contacts (Bauform / model / modèle A1, A2), (LS1) 1x Ausdrückwerkzeug 2mm Kontakte / Removal tool 2mm contact / Outil de demontage 2mm contacts (Bauform / model / modèle A1, A2), (LS1)	75001000*	1
°° Crimpzange klein / Crimping tool small / Pince à sertir petite 0,06 - 1,0 mm ² (1mm Kontakte / contacts / contacts)	75008000*	1
° Crimpzange groß / Crimping tool large / Pince à sertir grande 0,34 - 4,0 mm ² (1mm, 2mm Kontakte / contacts / contacts)	75008100*	1
Locator für Crimpzange groß / Locator for crimping tool large / Centreur pour pince à sertir grande 1mm Kontakte / contacts / contacts	75008600*	1
Locator für Crimpzange groß / Locator for crimping tool large / Centreur pour pince à sertir grande 2mm Kontakte / contacts / contacts	75008700*	1
Ersatz-Positionierer für Crimpzange klein / Spare positioner for crimping tool small / Centreur replacement pour pince à sertir petite	75008400*	1
Ersatz-Positionierer für Crimpzange groß / Spare positioner for crimping tool large / Centreur replacement pour pince à sertir grande	75008500*	1
Servicekoffer für Rundsteckverbinder / Service case for circular connectors / Set montage pour connecteurs circulaires	75010000	1

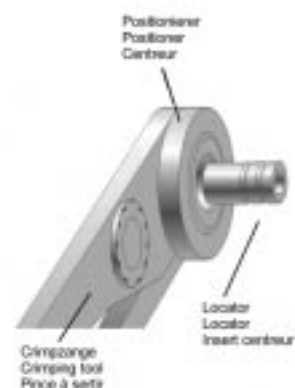

° Hinweis: inclusive Positionierer

°° inclusive Positionierer und Locator

° Note: Positioner included

°° Positioner and locator included

° Remarque: avec centreur

°° avec centreur at insert centreur

6.3 EPIC® C I R C O N P P 1

Rundsteckverbinder / *Circular connector* / *Connecteur circulaire*

Rundsteckverbinder zur Signalübertragung mit neuartiger Push-Pull Verriegelung für einfaches Stecken. Der neue Rundsteckverbinder der Serie PP1 wurde speziell für engste Platzverhältnisse konstruiert. So kann man Dank des neuen Push-Pull Systems diesen Steckverbinder auch an schwer zugänglichen Stellen einsetzen.

Circular connector for signal transmission with novel push-pull locking for simple plugging. The new circular connector of the series PP1 was specifically designed for very narrow space conditions. With this new push-pull system, it is possible to use this circular connector in places which are hardly accessible.

Connecteur circulaire pour la transmission de signaux avec nouveau verrouillage push-pull pour faciliter l'enfichage.

Les nouveaux connecteurs circulaire de la série PP1 ont été conçus spécialement pour les endroits très étroits. Il est ainsi possible, grâce au nouveau système push-pull, d'utiliser ce connecteur même dans les endroits difficiles d'accès.



6.3 EPIC® C I R C O N P P 1

Rundsteckverbinder / Circular connector / Connecteur circulaire

Technische Daten:

- Polzahl 17+2 (17x1mm; 2x2mm)
- Verschmutzungsgrad 3
- Bemessungsspannung 36 V, AC
- Bemessungsstrom 7,5/16 A
- Temperaturbereich -25 bis +80° C
- Schutzart IP 54 gesteckt nach DIN 40 050
- Leitungsanschluß Löt, 0,5 mm² / 2,5 mm²
- Steckzyklen > 500

Material

- Gehäuse PA 6.6
- Isolierkörper Glasfaserverstärkter Thermoplast
- Kontaktoberfläche Kupferlegierung, vergoldet
- Klemmbereich 5 – 12mm

Technical Data:

- Number of contacts 17+2 (17x1mm; 2x2mm)
- Pollution degree 3
- Rated voltage 36 V, AC
- Rated current 7,5/16 A
- Temperature range -25 bis +80° C
- Protection class IP 54 mated, DIN 40 050
- Termination Solder, 0,5 mm² / 2,5 mm²
- Mating cycles > 500

Material

- Housing PA 6.6
- Insulation body Thermoplast
- Contacts Copper alloy, gold plated
- Cable diameter 5 – 12mm

Caractéristiques techniques

- Nombre de contacts 17+2 (17x1mm; 2x2mm)
- Degré de pollution 3
- Tension nominale 36 V, AC
- Courant nominale 7,5/16 A
- Gamme de température -25 bis +80° C
- Degré de protection IP 54 embroché DIN 40 050
- Raccordement à souder, 0,5 mm² / 2,5 mm²
- Cycles d'insertion > 500

Matière

- Boîtier PA 6.6
- Isolant Plastique thermoforme
- Contacts Alliage cuivre, doré
- Diamètre câble 5 – 12mm

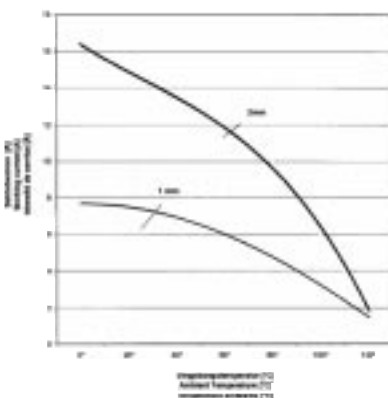

6.3 EPIC® C I R C O N P P 1

Rundsteckverbinder / *Circular connector* / *Connecteur circulaire*

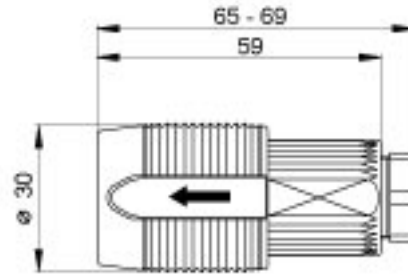

Bauform D inclusive Kontakte

Style D, Connector, contacts included

Modèle D Connecteur avec contacts

Ansicht steckseitig <i>view form mating side</i> <i>vue côté de connection</i>	Artikel <i>part</i> <i>article</i>	Version <i>version</i> <i>version</i>	Art.Nr. <i>part No.</i> <i>N° art.</i>	Verschraubung <i>cable gland</i> <i>presse-étoupe</i>	VPE <i>packing unit</i> <i>conditionnement</i>
	Push-Pull	Stift / <i>male</i> / <i>mâle</i>	14281500	PG 11	5
	Push-Pull	Buchse / <i>female</i> / <i>femelle</i>	14281000	PG 11	5

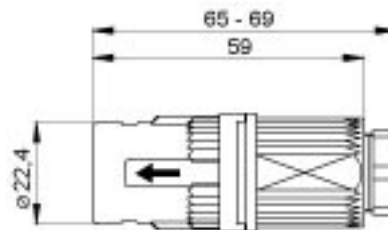

Bauform F Kupplung inclusive Kontakte

Style F, Cable connector, contacts included

Modèle F Prolongateur avec contacts

Ansicht steckseitig <i>view form mating side</i> <i>vue côté de connection</i>	Artikel <i>part</i> <i>article</i>	Version <i>version</i> <i>version</i>	Art.Nr. <i>part No.</i> <i>N° art.</i>	Verschraubung <i>cable gland</i> <i>presse-étoupe</i>	VPE <i>packing unit</i> <i>conditionnement</i>
	Push-Pull	Stift / <i>male</i> / <i>mâle</i>	14282000	PG 11	5
	Push-Pull	Buchse / <i>female</i> / <i>femelle</i>	14282500	PG 11	5

6.3 EPIC® C I R C O N P P 1

Rundsteckverbinder / Circular connector / Connecteur circulaire

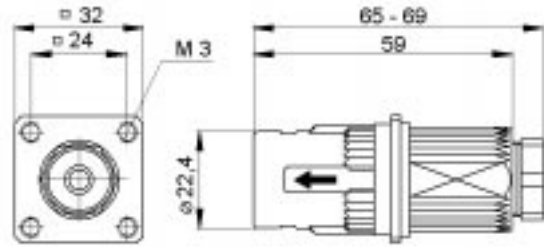

Bauform F1 Kupplung inclusive Kontakte Style F1, Cable connector, contacts included Modèle F1 Prolongateur avec contacts

Ansicht steckseitig view form mating side vue côté de connection	Artikel part article	Version version version	Art.Nr. part No. N° art.	Verschraubung cable gland presse-étoupe	VPE packing unit conditionnement
	Push-Pull	Stift / male / mâle	14283000	PG 11	5
	Push-Pull	Buchse / female / femelle	14283500	PG 11	5

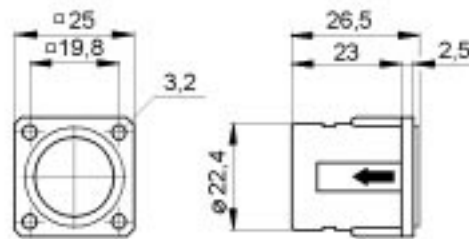

Bauform A Einbaudose inclusive Kontakte Style A, Panel mount base, contacts included Modèle A Prise encastrée avec contacts

Ansicht steckseitig view form mating side vue côté de connection	Artikel part article	Version version version	Art.Nr. part No. N° art.	VPE packing unit conditionnement
	Push-Pull	Stift / male / mâle	14280000	5
	Push-Pull	Buchse / female / femelle	14280500	5

6.4 EPIC® C I R C O N R 3.0

Rundsteckverbinder / *Circular connector* / *Connecteur circulaire*

Die Rundsteckverbinder Serie R3.0 sind eine Alternative zur Serie R2.5, insbesondere dort wo höhere Polzahlen gefordert sind. Die Serie R3.0 ist erhältlich in den Polzahlen 21 und 26.

The circular connector series R3.0 is an alternative to the series R2.5, especially where higher numbers of contacts are required. The series R3.0 is available with 21 and 26 contacts.

Les connecteurs circulaire de la série R3.0 représentent une alternative à la série R2.5 là où un nombre de pôles plus élevé est exigé. La série R3.0 est disponible en 21 et 26 contacts.



6.4 EPIC® C I R C O N R 3.0

Rundsteckverbinder / Circular connector / Connecteur circulaire

Technische Daten:

- Polzahlen 21, 26
- Bemessungsspannung 60 V, AC
- Prüfspannung: 1,5 kV, AC
- Verschmutzungsgrad 2
- Bemessungsstrom: 7,5 A

- Temperaturbereich: -40°C - +125°C
- Schutzart: IP 65...IP67 gesteckt, DIN 40 050
Verschraubungsabhängig

- Leitungsanschluß: Löt bis 1mm²
Einlöt Ø 1mm;
3,7 – 4,7mm lang

- Durchgangswiderstand < 3 (mΩ)
- Steckzyklen > 500

Material

- Gehäuse Kupferlegierung vernickelt
- Isolierkörper Thermoplast UL 94 V-0
- Dichtungen Neopren
- Kontakte Kupferlegierung, vergoldet

Technical Data:

- Number of contacts 21, 26
- Rated voltage 60 V, AC
- Test voltage: 1,5 kV, AC
- Pollution level 2
- Rated current: 7,5 A

- Temperature range: -40°C - +125°C
- Protection class: IP 65...IP67 mated, DIN 40 050
Dependant on cable gland

- Wire gauge Solder up to 1mm²
PCB solder Ø 1mm;
3,7 – 4,7mm long

- Contact resistance < 5 (mΩ)
- Mating cycles > 500

Material

- Housing Copper alloy, nickel plated
- Insulation body thermopast according to UL 94 V-0
- Gaskets Neopren
- Contacts Copper alloy, gold plated

Caractéristiques techniques:

- Nombre de contacts 21, 26

- Tension nominale 60 V, AC
- Tension d'essai: 1,5 kV, AC
- Degré de pollution 2
- Courant nominale: 7,5 A

- Gamme de température: -40°C - +125°C
- Degré de protection: IP 65...IP67 embroché, DIN 40 050
Dépendant de presse-étoupe à souder 1,0 mm² à souder sur ci Ø 1mm; 3,7 - 4,7mm longue

- Raccordement

- Résistance de passage < 5 (mΩ)
- Cycles d'insertion > 500

Matière

- Boîtier Alliage cuivre, nickelé
- Isolant Plastique thermoformé UL 94 V-0
Neopren

- Joints Neopren
- Contacts Alliage cuivre, doré

6.4 EPIC® C I R C O N R 3.0

Rundsteckverbinder / *Circular connector* / *Connecteur circulaire*

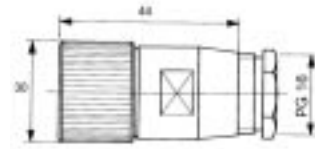

Bauform D6 (Stecker, Kabelverschraubung)

Style D6 (Connector, cable gland)

Modèle D6 (Connecteur, presse-étoupe)

Artikel <i>part</i> <i>article</i>	Art.Nr. <i>part No.</i> <i>N° art.</i>	Codierung <i>Coding</i> <i>Codage</i>	VPE <i>packing unit</i> <i>conditionnement</i>
BF D6	202040AF	N	10

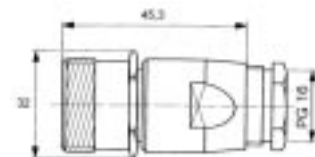

Bauform D6 (Kupplung, Kabelverschraubung)

Style D6 (Cable connector, cable gland)

Modèle D6 (Prolongateur, presse-étoupe)

Artikel <i>part</i> <i>article</i>	Art.Nr. <i>part No.</i> <i>N° art.</i>	Codierung <i>Coding</i> <i>Codage</i>	VPE <i>packing unit</i> <i>conditionnement</i>
BF F6	202050AF	N	10

Hinweis: Beispiel für Bestellung (Gehäuse + Isolierkörper -> 202010AA + 40200121)

Note: Example for order (Housing + Insulation body -> 202010AA + 40200121)

Remarque: Exemple pour commande (Boîtier + isolant-> 202010AA + 40200121)

6.4 EPIC® C I R C O N R 3.0

Rundsteckverbinder / *Circular connector* / *Connecteur circulaire*

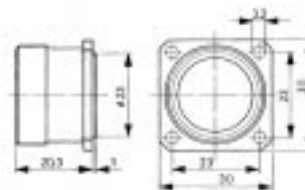

Bauform A Einbaudose (Frontmontage)
Style A panel mount base (front assembly)
Modèle A prise encastrée (montage frontal)

Artikel <i>part</i> <i>article</i>	Art.Nr. <i>part No.</i> <i>N° art.</i>	Codierung <i>Coding</i> <i>Codage</i>	VPE <i>packing unit</i> <i>conditionnement</i>
BF A	202010AA	N	10

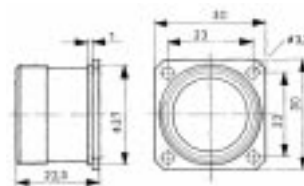

Bauform B2 Einbaudose (Hinterwandmontage)
Style B2 panel mount base (back-wall assembly)
Modèle B2 prise encastrée (montage sur paroi arrières)

Artikel <i>part</i> <i>article</i>	Art.Nr. <i>part No.</i> <i>N° art.</i>	Codierung <i>Coding</i> <i>Codage</i>	VPE <i>packing unit</i> <i>conditionnement</i>
BF B2	202030AA	N	10

Hinweis: Beispiel für Bestellung (Gehäuse + Isolierkörper -> 202010AA + 40200121)

Note: Example for order (Housing + Insulation body -> 202010AA + 40200121)

Remarque: Exemple pour commande (Boîtier + isolant-> 202010AA + 40200121)

6.4 EPIC® C I R C O N R 3.0

Rundsteckverbinder / *Circular connector* / *Connecteur circulaire*

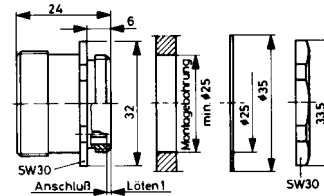

Bauform G1 Einbaudose (Einlochmontage)

Style G1 panel mount base (single hole assembly)

Modèle G1 prise encastrée (prise avec écrou de fixation)

Artikel <i>part</i> <i>article</i>	Art.Nr. <i>part No.</i> <i>N° art.</i>	Codierung <i>Coding</i> <i>Codage</i>	VPE <i>packing unit</i> <i>conditionnement</i>
BF A	202060AA	N	10

Hinweis: Beispiel für Bestellung (Gehäuse + Isolierkörper -> 202010AA + 40200121)

Note: Example for order (Housing + Insulation body -> 202010AA + 40200121)

Remarque: Exemple pour commande (Boîtier + isolant-> 202010AA + 40200121)

6.4 EPIC® C I R C O N R 3.0

Rundsteckverbinder / Circular connector / Connecteur circulaire

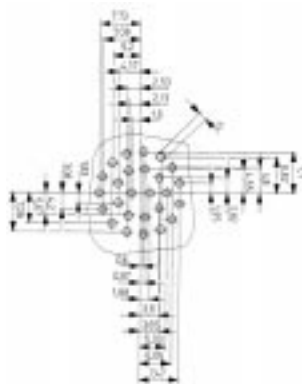

26 contacts

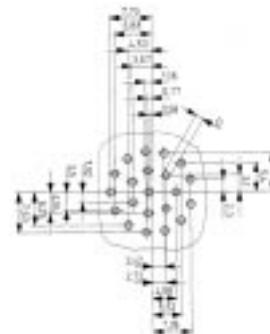

21 contacts

Isolierkörper / Insulation body / Isolant

Ansicht steckseitig <i>view from mating side</i> <i>vue côté de connection</i>	Kontakte <i>contacts</i> <i>contacts</i>	Isolierkörper + Stiftkontakte löt <i>insulation body + male contacts solder</i> <i>isolant + contacts mâle à souder</i>	Isolierkörper + Buchsenkontakte löt <i>insulation body + female contacts solder</i> <i>isolant + contacts femelle à souder</i>	Isolierkörper Stiftkontakte einlöt <i>insulation body + male contacts PCB solder</i> <i>isolant + contacts mâle à souder sur ci</i>	Isolierkörper Buchsenkontakte einlöt <i>insulation body + female contacts PCB solder</i> <i>isolant + contacts femelle à souder sur ci</i>	Für Bauform <i>for model</i> <i>pour modèle</i>	VPE <i>packing unit</i> <i>conditionnement</i>
--	--	--	---	--	---	---	--

P-Teil / P-Part / P-Pièce
 Linksdrehend / turning anti-clockwise / rotation à gauche

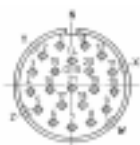

21

40250121

A/B/D/F/G

10

21

40264121

A/B

10



26

40250126

A/B/D/F/G

10

26

40264126

A/B

10

E-Teil / E-Part / E-Pièce
 Rechtsdrehend / turning clockwise / rotation à droite



21

40200121

A/B/D/F/G

10

21

40212121

A/B

10

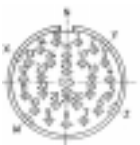

26

40200126

A/B/D/F/G

10

26

40212126

A/B

10

Hinweis: Beispiel für Bestellung (Gehäuse + Isolierkörper -> 202010AA + 40200121)

Note: Example for order (Housing + Insulation body -> 202010AA + 40200121)

Remarque: Exemple pour commande (Boitier + isolant-> 202010AA + 40200121)

6.4 EPIC® C I R C O N R 3.0

Rundsteckverbinder / *Circular connector* / *Connecteur circulaire*



Zubehör und Ersatzteile

Accessories

Accessoires

Artikel <i>part</i> <i>article</i>	Art.Nr. <i>part No.</i> <i>N° art.</i>	Für Bauform <i>for model</i> <i>pour modèle</i>					VPE <i>packing unit</i> <i>conditionnement</i>
		A1	B2	D6	F6	G1	
Flanschdichtung <i>Flat gasket</i> <i>Joint plat</i>	50201203 50202203	●	●				10 10
Dichtring <i>Sealing ring</i> <i>Anneau d'étanchéité</i>	50206204					●	10
Metallschraubkappe <i>Metal screw cap</i> <i>Bouchon d'étanchéité</i>	50201120 50203120 50204121 50205121 50206125	●	●	●	●	●	10 10 10 10 10
Winkelgehäuse <i>Angled housing</i> <i>Boitier á 90° degré</i>	502012AC	●					10
Montage/Werkzeug <i>Assembly tool</i> <i>Util assemblage</i>	50200800			●	●		1

7.1 EPIC® BUS

Interbusanwendung / *INTERBUS application* / Système *INTERBUS*

Steuerungen werden immer komplexer, das erfordert sichere Übertragungslösungen. Dafür wurde das neue EPIC LWL-System entwickelt. Es bietet alle Vorteile der modernen Lichtwellenleitertechnik verbunden mit den bewährten EPIC-Standards, im Modul-System, im klassischen Rechtecksteckverbinder und im neuen Rundsteckverbinder mit im Stecker integrierten Optokoppler.

Control systems are becoming ever more complex, which means that reliable transmission solutions are required. The new EPIC optical fibre system was developed for this very purpose, offering all the advantages of modern optical fibre technology combined with the tried and tested EPIC standards, in a modular system, in the conventional rectangular connector and in the new circular connector with optocoupler integrated into them.

Les automatismes deviennent de plus en plus complexes, cela exige des moyens de transmission sûrs. C'est pourquoi nous avons conçu le nouveau système EPIC pour fibres optiques. Il offre tous les avantages de la transmission par fibre optique, dans le cadre des connexions standard EPIC. Modulaire, le système se monte dans les connecteurs rectangulaires classiques et les nouveaux connecteurs circulaire - avec optocoupleur intégré.



7.1 EPIC® BUS

Interbusanwendung / INTERBUS application / Système INTERBUS

Technische Daten

INTERBUS

- Lichtwellenleiter Steckverbindersystem
- Schnittstelle:RS 485
- Schutzart:IP 65
- Temperaturbereich:-20°C – +85°C

Übertragungsparameter

- Wellenlänge:660 nm
- Übertragungslänge:40 m
- Übertragungsrate:0 - 500 kBit/s
- Kontaktzahl:9/8+1

Lichtwellenleiter für Modulares System

- für Fasertyp:Kunststoff-Faser: ..(POF)
Durchmesser:1 mm
Wellenlänge:660 nm

Technical Data

INTERBUS

- *Optical fibre connector system*
- *Interface:RS 485*
- *Protection class:IP 65*
- *Temperature range:-20°C – +85°C*

Transmission parameters

- *Wavelength:660 nm*
- *Transmission distance:40 m*
- *Transmission rate:0 - 500 kBit/s*
- *Number of contacts:9/8+1*

Optical fibres for Modular System

- *for fibre type:plastic fibre:(POF)*
diameter:1 mm
wavelength:660 nm

Caractéristiques techniques

INTERBUS

- *Connecteurs pour fibres optiques*
- *Interface:RS 485*
- *Degré de protection:IP 65*
- *Gamme de température:-20°C – +85°C*

Paramètres de transmission

- *Longueur d'onde:660 nm*
- *Longueur de transmission:40 m*
- *Vitesse de transmission:0 - 500 kBit/s*
- *Nombre de contacts:9/8+1*

Fibre optique pour système modulaire

- *Type de fibre:Fibre en plastique: ..(POF)*
Diamètre:1 mm
Longueur d'onde: .660 nm

7.1 EPIC® B U S

Interbusanwendung / *INTERBUS application* / Système *INTERBUS*

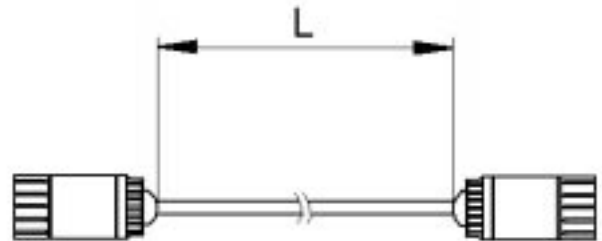

INTERBUS

Rundsteckverbinder / Rundsteckverbinder
Circular connector / circular connector
Connecteur circulaire / connecteur circulaire

Artikel <i>part</i> <i>article</i>	Version <i>version</i> <i>version</i>	Art.Nr. <i>part No.</i> <i>N° art.</i>	Kabellänge L <i>cable length L</i> <i>longeur de cable L</i>
INTERBUS L=2 R/R	Rund Buchse - Rund Stift / <i>circular female - circular male</i> <i>femelle circulaire - mâle circulaire</i>	13091000	2 m
LWL INTERBUS L=5 R/R	Rund Buchse - Rund Stift / <i>circular female - circular male</i> <i>femelle circulaire - mâle circulaire</i>	13091100	5 m
LWL INTERBUS L=10 R/R	Rund Buchse - Rund Stift / <i>circular female - circular male</i> <i>femelle circulaire - mâle circulaire</i>	13091200	10 m
LWL INTERBUS L=20 R/R	Rund Buchse - Rund Stift / <i>circular female - circular male</i> <i>femelle circulaire - mâle circulaire</i>	13091300	20 m

7.1 EPIC® B U S

Interbusanwendung / *INTERBUS application* / *Système INTERBUS*

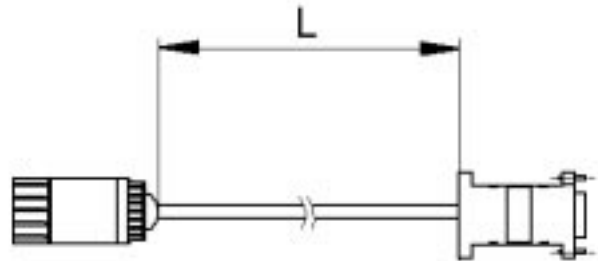
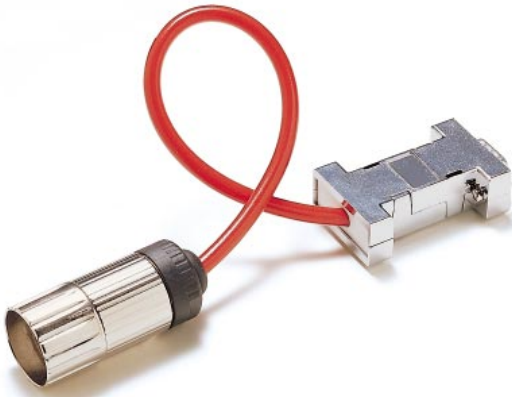

INTERBUS

Rundsteckverbinder / Sub-D

Circular connector / Sub-D

Connecteur circulaire / Sub-D

Artikel <i>part</i> <i>article</i>	Version <i>version</i> <i>version</i>	Art.Nr. <i>part No.</i> <i>N° art.</i>	Kabellänge L <i>cable length L</i> <i>longeur de cable L</i>
LWL INTERBUS L=2 R/Sub-D	Rund Stift - Sub-D Buchse / <i>circular male - Sub-D female</i> <i>mâle circulaire - femelle Sub-D</i>	13092000	2 m
LWL INTERBUS L=5 R/Sub-D	Rund Stift - Sub-D Buchse / <i>circular male - Sub-D female</i> <i>mâle circulaire - femelle Sub-D</i>	13092100	5 m
LWL INTERBUS L=10 R/Sub-D	Rund Stift - Sub-D Buchse / <i>circular male - Sub-D female</i> <i>mâle circulaire - femelle Sub-D</i>	13092200	10 m
LWL INTERBUS L=20 R/Sub-D	Rund Stift - Sub-D Buchse / <i>circular male - Sub-D female</i> <i>mâle circulaire - femelle Sub-D</i>	13092300	20 m
LWL INTERBUS L=2 Sub-D/R	Sub-D Stift - Rund Buchse / <i>Sub-D male - circular female</i> <i>mâle Sub-D - femelle circulaire</i>	13093000	2 m
LWL INTERBUS L=5 Sub-D/R	Sub-D Stift - Rund Buchse / <i>Sub-D male - circular female</i> <i>mâle Sub-D - femelle circulaire</i>	13093100	5 m
LWL INTERBUS L=10 Sub-D/R	Sub-D Stift - Rund Buchse / <i>Sub-D male - circular female</i> <i>mâle Sub-D - femelle circulaire</i>	13093200	10 m
LWL INTERBUS L=20 Sub-D/R	Sub-D Stift - Rund Buchse / <i>Sub-D male - circular female</i> <i>mâle Sub-D - femelle circulaire</i>	13093300	20 m

7.1 EPIC® B U S

Interbusanwendung / *INTERBUS application* / Système *INTERBUS*

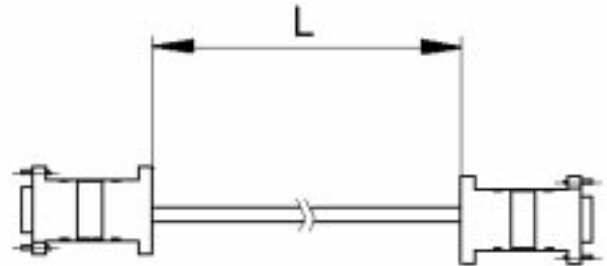
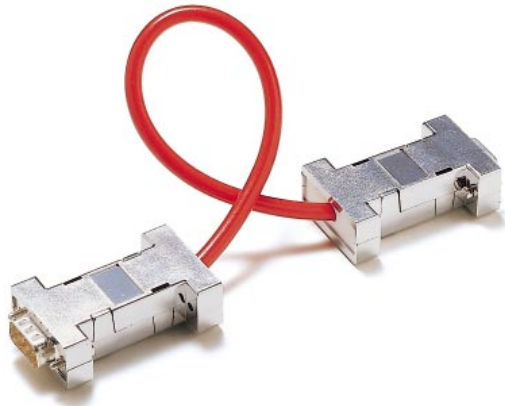

INTERBUS

Sub-D / Sub-D

Sub-D / Sub-D

Sub-D / Sub-D

Artikel <i>part</i> <i>article</i>	Version <i>version</i> <i>version</i>	Art.Nr. <i>part No.</i> <i>N° art.</i>	Kabellänge L <i>cable length L</i> <i>longueur de cable L</i>
LWL INTERBUS L=2 Sub-D/Sub-D	Sub-D Buchse - Sub-D Stift / <i>Sub-D female - Sub-D male</i> <i>femelle Sub-D - mâle Sub-D</i>	13094000	2 m
LWL INTERBUS L=5 Sub-D/Sub-D	Sub-D Buchse - Sub-D Stift / <i>Sub-D female - Sub-D male</i> <i>femelle Sub-D - mâle Sub-D</i>	13094100	5 m
LWL INTERBUS L=10 Sub-D/Sub-D	Sub-D Buchse - Sub-D Stift / <i>Sub-D female - Sub-D male</i> <i>femelle Sub-D - mâle Sub-D</i>	13094200	10 m
LWL INTERBUS L=20 Sub-D/Sub-D	Sub-D Buchse - Sub-D Stift / <i>Sub-D female - Sub-D male</i> <i>femelle Sub-D - mâle Sub-D</i>	13094300	20 m

GENERAL CONDITIONS OF SALE AND DELIVERY

(valid from 1th of january 1998)

When these conditions of sale and delivery are published all previous conditions will no longer be applicable.

All offers are also based on these conditions of sale and delivery.

I. General Terms

1. For the conclusion of a contract of sale and scope of supply commitments resulting from this conclusion it is relevant that both contracting parties make corresponding declarations of intention in writing. Should such written declarations of intention be absent the only written acknowledgement of order of supplier will be legally binding. In this connection the conditions of sale and delivery mentioned below are applied as agreed upon.
2. All deliveries and performances – henceforth as well – of CONTACT GmbH including additional performances such as consultancy before and after conclusion are exclusively effected by virtue of the following conditions, also for any kind of business of adjustment. The buyer's conditions of purchase are hereby contradicted. They do not engage CONTACT either if we do not contradict again when the contract is concluded. It is understood that the general conditions of delivery and payment are accepted by receipt of our goods at the latest.
3. Offers of CONTACT GmbH are not binding. Conclusions and agreements – especially as far as they differ from our conditions – will not be binding for us until they are confirmed by us in writing.
4. These conditions are also applied for sales on the basis of trade terms, especially those of Incoterms. For sales on the basis of one of these contract formula of Incoterms those Incoterms as may from time be established are relevant. However, the trade terms are only applied in so far as there are not taken any other regulations in these conditions or in particular agreements.

II. Scope and Duty to Deliver

1. Documents, illustrations, drawings and indications of weight belonging to the offer of CONTACT GmbH, only prevail approximately. Modifications of each kind will be reserved in the interest of technical progress, the latest experiences and improvements. Exceptions need to be confirmed in written form. CONTACT explicitly reserves the right of ownership and copyright of all documents. Offers and documents belonging to them must not be accessible to third parties without our written consent. By request these documents, drawings, samples, etc. belonging to the offer have to be given back immediately.
2. In case of special manufacturing a variation of + 10 percent of the required quantity are binding for the purchaser. This is also applicable for partial quantities.

III. Pricing

1. In case of delivery prices are only applicable for the respective order confirmed ex works excluding packing as far as nothing else has been determined in writing. In case of general changes of production costs until delivery day CONTACT GmbH reserves the right to price corrections. Prices are understood plus legal VAT.
2. If no other arrangements are made, samples will only be delivered if they are charged. All samples remain CONTACT's property until they are fully paid.
3. We reserve the right to surcharge increased costs of materials by correlating it with the quotation of raw materials at that time. If unforeseeable increases arise in labour or transport costs, taxes or charges between conclusion of contract and delivery, CONTACT is entitled to make a price adjustment according to these factors.
4. The minimum order value is DM 500,- net.

IV. Reservation of Ownership

1. The objects of deliveries (including conditional commodities) remain CONTACT's property until all claims due against the buyer and resulting from business contracts, are satisfied. As far as the value of all security rights due to CONTACT GmbH exceeds the amount of all secured claims by more than 20 percent CONTACT will release a respective part of security rights by request of the purchaser.
2. As long as reservation of ownership exists, pledge or assignment by bill of sale are forbidden to the buyer and resale is only permitted by resellers will be paid by this customer or will reserve the right that property does not go over to the customer until the latter has completely satisfied his liabilities to pay.
3. a) If the purchaser resells conditional commodities he will already, for reasons of security, assign his future claims to CONTACT resulting from the resale towards his customers, with all subsidiary rights – including any claims of balance, without the need of further special declarations. If conditional commodity is resold together with other objects without agreeing on a price per unit for the conditional commodity the purchaser transfers to the supplier CONTACT that part of total price required which corresponds to the price of conditional commodity charged by the supplier and by giving that part priority over remaining claims.
b) In case of satisfactory proof of a legitimate interest the purchaser has to give the necessary informations and to hand over the required documents to the supplier CONTACT GmbH to be able to assert his rights towards the customer.
c) Until revoked the purchaser is entitled to collect assigned debts resulting from resale. In case of an important reason, especially in case of default of payment, stoppage of payment, opening of a procedure of insolvency (bankruptcy, settlement, total execution), bill protest or if there are comparable justified indications which give notice of insolvency of the purchaser, the supplier is entitled to revoke the purchaser's authority to collect. Besides, after previous threat of disclosing assignment for security or realizing assigned debts and by observing an appropriate period, the supplier can disclose as-

ignment for security, realize assigned debts as well as require disclosure of assignment for security by the purchaser towards the customer.

- 4 a) The purchaser is permitted to process or transform conditional commodity or combine it with other objects. Processing, transformation or combination is done for the supplier CONTACT GmbH. The purchaser holds in safe custody the new object for the supplier CONTACT GmbH with the care of a prudent business man. The processed, transformed or combined object is regarded as conditional commodity.
- b) In case of processing, transformation or combination with other objects not belonging to CONTACT, CONTACT GmbH is entitled to joint ownership of the new object with a share resulting from the proportion of value of the processed, transformed or combined conditional commodity to the value of the remaining processed commodity at the moment of processing commodity at the moment of processing, transformation or combination. Provided that the purchaser acquires sole ownership of the new object, the supplier CONTACT GmbH and the purchaser agree that the purchaser concedes to the supplier CONTACT GmbH joint ownership of the new object created by processing, transformation or combination in relation of the value of the processed, transformed or combined conditional commodity to the remaining processed, transformed or combined commodity at the moment of processing, transformation or combination.
- c) In case the new object should be sold the purchaser will transfer to the supplier CONTACT GmbH his claim from resale against the customer with all subsidiary rights for reasons of security without the need of further special declarations. However, the assignment only applies to the value of the amount which corresponds to the value of processed, transformed or combined conditional commodity charged to the supplier CONTACT GmbH. The part of claim transferred to the supplier CONTACT GmbH has to be satisfied preferentially. With respect to the authority to collect as well as the conditions for your revocation number 3.c) is applicable accordingly.
d) If conditional commodity is combined with properties or movables by the purchaser, the purchaser will also transfer to the supplier CONTACT GmbH his claims to which he is entitled as a compensation for the combination, with all subsidiary rights for reasons of security. The claims amount to the relation of the value of combined conditional commodity to the remaining commodities at the moment of combination without the need of further special declarations.
5. In case of seizures, distraints or other orders or interferences of third parties, the purchaser has to inform the supplier CONTACT GmbH immediately.
6. When the purchaser culpably offends against essential contractual duties, especially in case of default of payment, the supplier CONTACT GmbH is entitled to take goods back after letter of reminder. The purchaser is obliged to return goods. In taking back or asserting reservation of ownership or in seizing delivery item by the supplier CONTACT GmbH should have declared this explicitly. After previous threat the supplier CONTACT GmbH is entitled to release conditional commodity taken back and to satisfy himself from the profits by crediting against outstanding claims.

V. Terms of Payment

1. As far as no adverse agreements are made in writing payments have to be made immediately free domicile of the supplier CONTACT GmbH. In case of default penal interest amounting to the interest rate for overdraft facility customary in banking are charged plus an adequate processing fee. The first day of time limit for payment is the date of issue of invoice. In case of default of the purchaser the supplier CONTACT GmbH can require immediate payment even of all debts due later regardless of adverse conditions.
2. The purchaser can only offset with such claims which are determined in an uncontested or valid way. When payments are held back the claim has to be based on the same contractual relationship.
3. Checks and bank credit transfers are only accepted on account of payment until they are lawfully discharged. Bills are only accepted on account of payment by previous agreement. Discount charges and interest have to be refunded to CONTACT GmbH. Due date of payments is the day when CONTACT has them at its disposal without reservation.
4. Unless otherwise agreed upon invoices are due to net payment within 30 days of the delivery date, if not otherwise stipulated. A 2% discount is allowed for payment within 10 days.
5. Terms of payment differing from those mentioned in paragraph V.1 to 3 need explicit written confirmation by the supplier CONTACT GmbH to be valid.

VI. Delivery periods

1. Delivery deadline begins with the day on which purchaser and supplier CONTACT GmbH have agreed on the order in writing. The observance of the delivery deadline requires punctual receipt of all documents to be delivered by the purchaser such as necessary approvals, clarification and approval of plans in time, the observance of terms of payments and other conditions. If these conditions are not satisfied for reasons not to be justified by us, delivery period will be extended accordingly. Delivery deadlines stated in the acknowledgement of order are mentioned to the best of our belief, but they are without guarantee. CONTACT is only responsible for the observance of delivery when it explicitly assumes warranty. Should these obligations not be satisfied in time there will be an appropriate extension of delivery deadline without an obligation of the supplier to damages.
2. Delivery deadline is applied subject to unforeseen events no matter if they occur in the factory of CONTACT GmbH or of its subcontractors – such as cases of force majeure, mobilization, war, reject of an important workpiece or other delays through no fault of their own during transport, breakdowns, strikes and

lockouts as well as subject to a delayed delivery through no fault of the supplier of essential rawand production materials as far as the events affect considerably completion or dispatch of delivery items as can be proved. This also applies to a delay which already exists. Whensuch events occur CONTACT GmbH has to inform the purchaser as soon as possible. An appropriate period of grace has to be granted to the supplier CONTACT GmbH.

3. Delivery deadline is considered as met when material is ready for shipment within the period or at the deadline.
4. If, by request of purchaser, dispatch or delivery is delayed as to settled delivery deadline, CONTACT reserves the right to invoice an appropriate storage fee.

VII. Passage of Risk

1. Risk passes to the buyer even if delivery at no charge has been agreed upon:
 - a) if shipment ready to operate left manufacturing plant of supplier CONTACT GmbH. Packing is done with due diligence, dispatch to the best of it's discretion without obligation of the supplier however. By request and costs of the buyer shipment will be insured by the supplier CONTACT GmbH against loss, breakage, transport and fire damages.
 - b) When dispatch or service delays occur and by request of the buyer risk passes to the buyer from the day when material is ready for shipment for the period of delay. However, CONTACT GmbH is obliged to effect respective insurances by request and at the expense of the purchaser.

VIII. Receipt and Performance

1. Delivered products have to be accepted even if they show irrelevant objections not obstructing the function of the product.
2. Part shipments are permitted.
3. Notice to the buyer that material corresponding to conditions of delivery, is ready for shipment is to be considered as performance of the contract.

IX. Liability for Defects of Delivery

CONTACT is liable for intention and gross negligence or for warranted qualities according to legal regulation. As for the rest excluding further claims, the company is liable for defects of delivery as follows:

1. At CONTACT's option all those parts or performances have to be rectified free of charge, to be delivered again or to be performed again which, within 12 months, excluding silver-plated and galvanized contacts, 6 months – for connectors the upper limit of insertion cycles must not be exceeded – calculated from the day of passage of risk, due to a circumstance lying before passage of risk, especially because of defective design, bad material or insufficient execution, become unusable or the usefulness of which was considerably impaired. The establishment of such identifiable defects according to § 377, § 378 and § 381 paragraph 2 German Commercial Code has to be reported in writing to CONTACT within eight days after receipt of goods at the place of destination by indicating delivery note and invoice number. When the complaint is lodged in time CONTACT GmbH is entitled at it's option to also rectify defects or deliver a substitute. A reduction of the compensation or the backing out of the contract can only be required if substitute delivery or rectification failed or was refused by us.
2. The purchaser has to meet obligations incumbent on him, especially agreed terms of payment. If a complaint is made, payments of the buyer may be withheld to an extent which are in adequate proportion to the defects found.
3. To rectify defects the purchaser has to grant CONTACT necessary time and opportunity at equitable discretion. If he refuses it, CONTACT will be relieved of warranty. When defects are found on parts not manufactured by CONTACT itself, CONTACT GmbH has to be granted sufficient time for the assertion towards our upstream suppliers as well as necessary correction of faults of our advance deliveries. In urgent cases of risk of safety in operation and for defense of exorbitant damages the buyer has to inform us immediately.
4. In right of the purchaser to assert claims resulting from defects is statute-barred in all cases from the moment of complaint by twelve months. If no agreement is reached within the time limit, the supplier CONTACT GmbH and the purchaser may agree on an extension on an extension of this limitation period.
5. Liability for defects does not refer to natural wear and tear, furthermore not to defects which arise after passage of risk due to defective or negligent treatment, excessive service, unsuitable production facilities, chemical electromechanic or electrical influences which, according to the contract, are not assumed.
6. By alterations or repairs improperly made by the purchaser or third parties without our previous consent or if parts not delivered by us or not released are used, liability for the consequences resulting from this are cancelled.
7. Warranty period for rectifications, substitute deliveries or substitute performances is 6 months. It runs at least until expiration of the original period of warranty for the delivery item. The period for liability is extended for the duration of plant interruption which arises by the fact that rectifications, substitute deliveries or substitute performances become necessary for those parts which cannot be operated pertinently because of interruption.
8. Further claims of the purchaser towards CONTACT GmbH and it's assistants are excluded, especially a claim for substitute of damages which did not appear on the delivery item itself, as well as from positive breach of contract, from violation of duties during contract negotiations and from tortious act. This is not applicable as far as there is compelling liability according to law of product liability e.g. in case of personal damage or damages on privately used things or in cases of intention, gross negligence or the absence of warranted qualities. As far as CONTACT GmbH is bound to damages, this obligation is always restricted to damage foreseeable at the moment of conclusion of contract.
9. Liability for repair at expiration of the liability term is only taken if this is explicitly agreed upon in writing.

10. The points 1-10 are applied accordingly for such claims of the purchaser for rectification, substitute delivery or compensation in damages which arise by propositions or deliberations resulting within the frame of the contract or by violation of contractual subsidiary duties.

11. Return deliveries are only possible with return number, in original packing and technical standard, according to prior agreement. If this is omitted, receipt of goods will be refused. The handling fee therefor are 30 % of the value.

12. Credit notes from return deliveries are exclusively offset against follow up orders and not paid out in monetary units.

X. Impossibility of Performance, Adjustment of Contract

1. If delivery or performance incumbent on CONTACT GmbH or on the purchaser becomes impossible, general principles of law subject to the following condition are applied: If the impossibility can be attributed through fault of CONTACT GmbH, the purchaser is entitled to claim damages. However, claim for damages of the purchaser is restricted to 10 percent of the value of that part of delivery or performance which cannot be put into pertinent operation because of impossibility. Claims for damages exceeding the mentioned limit amounting to 10 percent are excluded. This is not applicable as far as there is compelling liability in cases of intention or gross negligence. The purchaser's right to withdraw from the contract will not be affected.
2. f unforeseen events as defined by point VI., 2. considerably change the economic significance or the contents of delivery or performance considerably affect the operation of the supplier the contract will be adjusted in an adequate way as far as this corresponds to good faith. As far as this is not reasonable economically, the supplier is entitled to cancel the contract. If he wants to avail himself of this right to rescind the contract he has to inform the purchaser immediately about it after realizing the consequence of the event and in fact, even if an extension of delivery period was settled first.

XI. Place of Jurisdiction

1. f the purchaser is full merchant as defined by § 38 paragraph 1 Code of Civil Procedure, the supplier's headquarters or its brach will be sole place of jurisdiction for all disputes resulting indirectly or directly from the contractual relationship at CONTACT's option.
2. German law will be applied for contractual relations.

XII. Euro-Clause

The replacement to be expected of the German currency of D-Mark by the sole currency of Euro of the European Monetary Union which will be effected on the official change-over deadline and at the official conversation rate, and the corresponding discharge of debts in Euro as well as all consequences incurred in connection with this currency reform do not justify any violation of contract nor do they entitle one of the contracting parties to legal grounds.

XIII. Commitment of Contract

1. Even in case of legal invalidity of different points the contract will be binding for ist remaining parts.
2. Conditions of the purchaser being in contradiction to these conditions are not binding for CONTACT GmbH even if they were the basis of the order and CONTACT GmbH did not contradict ist contents explicitly.

CONTACT's conditions of sale and delivery are oriented by the recommendations of conditions of the Zentralverband Elektrotechnik und Elektroindustrie (Central Association of the Electrical Industrie), edition: February 1996

* ab Lager lieferbar
 * ex stock
 * disponible

ohne* kurzfristig lieferbar
 without* short delivery time
 sans* délai très court

Art. Nr. part No. N° art.	Seite page page	Art. Nr. part No. N° art.	Seite page page	Art. Nr. part No. N° art.	Seite page page	Art. Nr. part No. N° art.	Seite page page
10003000*	167	10076000	185	10156000*	155	10239010*	73
10004000*	168	10076900*	177	10157000*	155	10239110*	73
10005000*	173	10078900*	175	10158000*	157	10240010*	73
10006000*	171	10080000*	159	10159000*	157	10240110*	73
10007000*	177	10080900*	155	10160000	157	10270010*	73
10009000*	175	10081000*	161	10161000*	167	10270110*	73
10011000*	155	10082000*	163	10165000	173	10271010*	73
10012000*	157	10082900*	157	10165100	173	10271110*	73
10014000*	187	10083000*	165	10166000	171	10381000*	94
10015000	210	10086000*	189	10166100	171	10381100*	94
10015100	210	10086900	187	10167000	177	10381200*	94
10016500	210	10087000	210	10167100	177	10381300*	94
10017000*	217	10087100	210	10168000	175	10381400*	94
10017100*	217	10088500	210	10168100	175	10381500*	94
10019000	212	10090000*	159	10170000*	69	10381600*	94
10019200	212	10092000*	163	10170600*	69	10381700*	94
10021000*	155	10092900*	157	10171000*	69	10382000*	90
10022000*	157	10102000*	169	10171600*	69	10382100*	90
10024000	187	10102900*	167	10180000*	62	10382200*	90
10032000*	169	10103000*	170	10181000*	62	10382300*	90
10032900*	167	10103900*	168	10182000*	62	10382400*	91
10033000*	170	10104000*	181	10183000*	62	10382500*	91
10033900*	168	10104900	173	10184000*	62, 63	10383200	88
10034000*	181	10105000*	179	10184200	63	10383300	88
10034100*	173	10105900	171	10185000*	62, 63	10383400	91
10034900*	173	10107000*	185	10185200	63	10383500	91
10035000*	179	10107900*	177	10186000*	63	10383600*	92
10035900	171	10109000	183	10186200	63	10383700*	92
10036000	185	10109900*	175	10187000*	63	10399000	89
10036900*	177	10111000*	159	10187200	63	10399100	89
10038000	183	10111900*	155	10190000*	60	10399200	88
10038900*	175	10112000*	161	10190100*	60	10399300	88
10040000*	159	10113000*	163	10191000*	60	10399400	89
10040100*	159	10113900*	157	10191100*	60	10399500	89
10040700	155	10114000*	165	10192000*	60	10399600*	92
10040900*	155	10117000	189	10192100*	60	10399700*	92
10041000*	161	10117900	187	10193000*	60	10399800*	93
10042000*	163	10118000	210	10193100*	60	10399900*	93
10042100*	163	10118100	210	10194000*	60,61	10400000	64
10042800*	157	10119500	210	10194100*	60,61	10400100	64
10042900*	157	10121000*	159	10195000*	60,61	10400200	64,65
10045000*	165	10121900*	155	10195100*	60,61	10400300	64,65
10046000*	189	10122000	161	10196000*	61	10400400	65
10046900	187	10123000*	163	10196100*	61	10400500	65
10047000	210	10123900*	157	10197000*	61	10401000	64
10047100	210	10124000	165	10197100*	61	10401100	64
10048500	210	10127000	189	10202000*	61	10401200	64,65
10049000*	217	10127900	187	10202100*	61	10401300	64,65
10049100*	217	10132000*	169	10203000*	61	10401400	65
10049500*	218	10134000*	160	10203100*	61	10401500	65
10072000*	169	10135000*	164	10204000*	61	10420000*	49
10072900*	167	10136000*	164	10204100*	61	10421000*	49
10073000*	170	10136600	166	10205000*	61	10422000*	140
10073900*	168	10137000*	181	10205100*	61	10422200*	140
10074000*	181	10138000	179	10210010*	73	10422500*	140
10074900*	173	10139500	190	10210110*	73	10423000*	140
10075000*	179	10152000*	168	10211010*	73	10423100*	140
10075900	171	10155000*	155	10211110*	73	10423500*	140

Art. Nr. part No. N° art.	Seite page page	Art. Nr. part No. N° art.	Seite page page	Art. Nr. part No. N° art.	Seite page page	Art. Nr. part No. N° art.	Seite page page
10424000*	143	10487200*	56	11147180	121, 123	11214200	130
10424200	143	10488100*	55	11147190	121, 123	11215000*	118
10424500*	143	10490200*	56	11147200	113, 115, 117	11215100*	118
10424700	143	10491100*	55	11147210	119	11215200	118
10425500*	135	10492200*	56	11147400	121	11215600	118
10426000*	135	10493100*	55	11147410	123	11215700	118
10426400*	135	10500200*	56	11153500	127, 129	11218000	114
10426500*	135	10501100*	55	11153600	127	11218100*	114
10426700*	135	10502200*	56	11153700	127, 129	11218200*	114
10427000*	135	10503100*	55	11153800	127, 129	11218300*	114
10427100	135	10511700	143	11158400	125	11218400*	114
10427300	135	10512100*	135	11160000	123, 129	11219100	111
10427500*	135	10512300	135	11161000*	111, 113, 121, 127	11219200	130
10429000*	149	10512700	143	11161200	214	11220700	126
10429100	149	10512900	149	11162000	214	11221000	120
10429200	149	10530000*	50,51	11171000*	115	11221300	120
10429500*	149	10531000*	50,51	11171100*	119, 131	11223000	126
10430000	209	10532000*	50,51	11171200*	93	11223500	120
10430100*	209	10533000*	50,51	11182500	117	11228000	126
10430300	209	10540000*	51	11171300	131	11228500	120
10430400	209	10540100	51	11184000	111	11230700	126
10431000*	49	10541000*	51	11184100	111	11231100	120
10432000*	49	10541100	51	11184200	111	11233100	120
10439000*	150	10542000*	51	11184300	111	11235700	126
10440000*	50	10542100	51	11184400	111	11236100	120
10440100*	50	10543000*	51	11184500	111	11238100	120
10441000*	50	10543100	51	11184700	111	11240700	126
10441100*	50	10563000	150	11190000	116	11241100	120
10442000*	141	10564000*	138	11190100	116	11243100	120
10445000*	138	10564500*	138	11190200*	116	11250000*	77
10445500*	138	10565000*	136	11190300	116	11250500*	77
10446000*	136	10565300*	136	11190400	116	11251000*	77
10446100*	136	10567000*	144	11192000	116	11251500*	77
10448000*	144	10567100*	144	11192100	116	11252500*	77
10448100*	144	10568000	144	11192200	116	11253500*	77
10450000*	144	10568100*	144	11195000	116	11255000	78
10450100*	144	10576000*	139	11195100	116	11255100*	78
10451200	214	10577000*	139	11195200*	116	11256000	78
10457500*	209	10578000*	139	11195300	116	11256100*	78
10457600	209	10579000	139	11195400	116	11260000	78
10457700	209	10582000*	137	11197000	116	11260200*	78
10457800	209	10583000*	137	11197100	116	11261000	78
10458000*	218	10584000	137	11197200	116	11261200*	78
10458100*	218	10585000	137	11201000	122	11265000	79,80
10462000*	141	10588000	151	11202000	122	11265200	79,80
10468000*	218	10588500	151	11205000	122	11266000	79,80
10468100*	218	10620300	149	11206000	122	11266200	79,80
10469500*	209	10620600	135	11208000	128	11270000	79,80
10469600*	209	10625500*	141	11208500	128	11271000	79,80
10469700	209	10630800*	139	11209000	128	11272000	79,80
10469800	209	10631800	137	11209500	128	11273000	79,80
10472000*	141	10633800	145	11210000	118	11280000	213
10474000*	145	10634800	146	11210100*	118	11281000	213
10474100*	145	11132500	125	11210200	118	11285000*	83
10481500*	209	11451200	214	11210600	118	11285100*	83
10481600*	209	11147000	113, 115, 117, 119, 121, 131	11210700	118	11285200*	83,84
10481700	209	11147100	113,115,117	11213000	114	11285300*	84
10481800	209	11147110	119	11213100*	114	11285400*	84
10482000	146	11147120	119	11213200*	114	11285500	84
10482100	146	11147130	131	11213300*	114	11286000*	83
10485200*	56	11147170	121	11213400*	114	11286100*	83
10486100*	55			11214100	111	11286200*	83,84

Art. Nr. part No. N° art.	Seite page page	Art. Nr. part No. N° art.	Seite page page	Art. Nr. part No. N° art.	Seite page page	Art. Nr. part No. N° art.	Seite page page
11286300*	84	202050AF	251	52004000	204	70011200	188
11286400*	84	202010AA	252	52004020	204	70011400	188
11286500	84	202030AA	252	52004050	204	70015200	178
11302500	124	202060AA	253	52004070	204	70015400	178
11302600	124	40250121	254	52004090	204	70016200	176
11302700	124	40264121	254	52004100	204	70016400	176
11302800	124	40250126	254	52004110	204	70017000	177
12954100	199	40264126	254	52004230	202	70017200	178
12954200	199	40200121	254	52004240	202	70017400	178
12954300*	199	40212121	254	52004250	202	70018000	175
12954400*	199	40200126	254	52004260	202	70018200	176
12954500*	199	40212126	254	52004270	202	70018400	176
12954600*	199	50201203	255	52005949	205	70020200	156
12954700	199	50202203	255	52005950	205	70020400	156
12954800	199	50206204	255	52005960	205	70021000	155
12957100*	199	50201120	255	52005970	205	70021200	156
12957200	199	50203120	255	52005980	205	70021400	156
12957300	199	50204121	255	52005990	205	70021600	155
12957400	199	50205121	255	52006000	205	70022200	158
13091000	259	50206125	255	52006010	205	70022400	158
13091100	259	502012AC	255	52006020	205	70023000	157
13091200	259	50200800	255	52015710	201	70023200	158
13091300	259	52000840	202	52015720	201	70023400	158
13092000	260	52000850	202	52015730	201	70023600	157
13092100	260	52000860	202	52015740	201	70032100	106
13092200	260	52000870	202	52015750	201	70032300	107
13092300	260	52000880	202	52015760	201	70032500	169
13093000	260	52000890	202	52015765	201	70032700	167
13093100	260	52000900	202	53015010	200	70033500	170
13093200	260	52001000	203	53015020	200	70033700	168
13093300	260	52001010	203	53015030	200	70035200	182
13094000	261	52001020	203	53015040	200	70035400	182
13094100	261	52001030	203	53015050	200	70036200	180
13094200	261	52001040	203	53015060	200	70036400	180
13094300	261	52001050	203	53015070	200	70037000	181
13162000*	112	52001060	203	53015610	200	70037200	182
13162100*	112	52001070	203	53015620	200	70037400	182
13162200*	112	52001080	203	53015630	200	70038000	179
13162300*	112	52001090	203	53015640	200	70038200	180
13162400*	112	52001100	203	53015650	200	70038400	180
13162500*	112	52001110	203	53112210	201	70040200	189
13162600*	112	52001120	203	53112220	201	70040400	190
13162700*	112	52001130	203	53112230	201	70040600	190
13162800*	112	52001140	203	53112240	201	70041000	189
13163000*	112	52001150	203	53112250	201	70041200	189
13163100*	112	52001160	203	53112260	201	70041400	190
13163200*	112	52002680	205	70002100	107	70041600	190
13163300*	112	52003390	205	70002500	167	70042200	187
13163400*	112	52003400	205	70004500	168	70042400	188
13163500*	112	52003410	205	70005200	174	70042600	188
13163600*	112	52003420	205	70005400	174	70043000	187
13163700*	112	52003430	205	70006200	172	70043200	187
13163800*	112	52003440	205	70006400	172	70043400	188
14280000	248	52003450	205	70007000	173	70043600	188
14280500	248	52003460	205	70007200	174	70044200	156
14281000	247	52003750	204	70007400	174	70044400	156
14281500	247	52003770	204	70008000	171	70045200	186
14282000	247	52003800	204	70008200	172	70045400	186
14282500	247	52003840	204	70008400	172	70046200	184
14283000	248	52003870	204	70010200	188	70046400	184
14283500	248	52003900	204	70010400	188	70047000	185
202040AF	251	52003930	204	70011000	187	70047200	186

Art. Nr. part No. N° art.	Seite page page	Art. Nr. part No. N° art.	Seite page page	Art. Nr. part No. N° art.	Seite page page	Art. Nr. part No. N° art.	Seite page page
70047400	186	70085200	182	70110400	174	70149600	156
70048000	183	70085400	182	70111200	172	70150400	160
70048200	184	70086200	180	70111400	172	70150600	160
70048400	184	70086400	180	70112000	173	70151000	159
70049000	155	70087000	181	70112200	174	70151200	159
70049200	156	70087200	182	70112400	174	70151400	160
70049400	156	70087400	182	70113000	171	70151600	160
70049600	155	70088000	179	70113200	172	70152400	164
70050400	160	70088200	180	70113400	172	70152600*	164
70050600	160	70088400	180	70114200	178	70153000	163
70051000	159	70090200	190	70114400	178	70153200	163
70051200	159	70090400	190	70115200	176	70153400	164
70051400	160	70091000	189	70115400	176	70153600	164
70051600	160	70091200	190	70116000	177	70154400	158
70052400	164	70091400	190	70116200	178	70154600	158
70052600	164	70092200	188	70116400	178	70155400	162
70053000	163	70092400	188	70117000	175	70155600	162
70053200	163	70093000	187	70117200	176	70156000	161
70053400	164	70093200	188	70117400	176	70156200	161
70053600	164	70093400	188	70132100	106	70156400	162
70054200	158	70094200	156	70132300	107	70156600	162
70054400	158	70094400	156	70132500	169	70157400	166
70055200	162	70095200	186	70132700	167	70157600	166
70055400	162	70095400	186	70133500	170	70158000	165
70056000	161	70096000	183	70133700	168	70158200	165
70056200	162	70096200	184	70135200	182	70158400	166
70056400	162	70096400	184	70135400*	182	70158600	166
70057200	166	70097000	185	70136200	180	70159000	157
70057400	166	70097200	186	70136400	180	70159200	157
70058000	165	70097400	186	70137000	181	70159400	158
70058200	166	70098000	183	70137200	182	70159600	158
70058400	166	70098200	184	70137400	182	70160200	174
70059000	157	70098400	184	70138000	179	70160400	174
70059200	158	70099000	155	70138200	180	70161200	172
70059400	158	70099200	156	70138400	180	70161400	172
70059600	157	70099400	156	70140400	190	70162000	173
70060200	174	70100200	160	70140600	190	70162200	174
70060400	174	70100400*	160	70141000	189	70162400	174
70061200	172	70101000	159	70141200	189	70163000	171
70061400	172	70101200	160	70141400	190	70163200	172
70062000	173	70101400	160	70141600	190	70163400	172
70062200	174	70102200	164	70142400	188	70164200	178
70062400	174	70102400*	164	70142600	188	70164400	178
70063000	171	70103000	163	70143000	187	70165200	176
70063200	172	70103200	164	70143200	187	70165400	176
70063400	172	70103400	164	70143400	188	70166000	177
70064200	178	70104200	158	70143600	188	70166200	178
70064400	178	70104400	158	70144400	156	70166400	178
70065200	176	70105200	162	70144600	156	70167000	175
70065400	176	70105400	162	70145200	186	70167200	176
70066000	177	70106000	161	70145400	186	70167400	176
70066200	178	70106200	162	70146200	184	70205000	162
70066400	178	70106400	162	70146400	184	70300000	98
70067000	175	70107200	166	70147000	185	70300100	98
70067200	176	70107400	166	70147200	186	70300500	98
70067400	176	70108000	165	70147400	186	70300600	98
70082100	106	70108200	166	70148000	183	70301000	98
70082300	107	70108400	166	70148200	184	70301100	98
70082500	169	70109000	157	70148400	184	70301500	98
70082700	167	70109200	158	70149000	155	70301600	98
70083500	170	70109400	158	70149200	155	70302000	98
70083700	168	70110200	174	70149400	156	70302100	98

Art. Nr. part No. N° art.	Seite page page	Art. Nr. part No. N° art.	Seite page page	Art. Nr. part No. N° art.	Seite page page	Art. Nr. part No. N° art.	Seite page page
70302500	99	70309230	104	70463000	138	71300000	101
70302600	99	70309231	104	70463200	138	71300100	101
70303000	98	70309232	104	70463400	138	71300500	101
70303100	98	70309233	104	70472500	141	71300600	101
70303500	99	70309234	104	70474000	142	71301000	101
70303600	99	70309235	104	70474500	142	71301100	101
70304000	99	70309236	104	70477200	144	71301500	101
70304100	99	70309237	104	70477400	144	71301600	101
70304500	99	70309238	104	70478200	144	71302000	101
70304600	99	70309239	104	70478400	144	71302100	101
70305000	99	70309240	104	70480200	150	71302500	102
70305100	99	70309241	104	70480400	150	71302600	102
70305500	99	70350000	221	70481000	150	71303000	101
70305600	99	70350100	221	70481200	150	71303100	101
70306000	100	70350200	221	70481400	150	71303500	102
70306100	100	70350300	221	70485200	147	71303600	102
70306500	100	70352000	221	70485400	147	71304000	102
70306600	100	70352100	222	70486200	147	71304100	102
70307000	100	70352200	222	70486400	147	71304500	102
70307100	100	70352300	222	70487200	147	71304600	102
70307500	100	70364000*	193	70487400	147	71305000	102
70307600	100	70364100*	195	70488200	147	71305100	102
70308000	105	70364200*	193	70488400	147	71305500	102
70308010	105	70364300*	195	70490200	136	71305600	102
70308020	105	70365000*	194	70490400	136	71306000	103
70308030	105	70365100*	196	70491000	136	71306100	103
70308100	105	70365200*	194	70491200	136	71306500	103
70308200	105	70365300*	196	70491400	136	71306600	103
70309000	104	70366000*	193	70492200	138	71307000	103
70309100	104	70366100*	195	70492400	138	71307100	103
70309101	104	70366200*	193	70493000	138	71307500	103
70309102	104	70366300*	195	70493200	138	71307600	103
70309200	104	70367000*	194	70493400	138	71318000	105
70309201	104	70367100*	196	70502500	141	71318100	105
70309202	104	70367200*	194	70503000	142	71318200	105
70309203	104	70367300*	196	70503500	142	71318300	105
70309204	104	70442500	141	70507200	145	71318400	105
70309205	104	70444000	142	70507400	145	71318500	105
70309206	104	70444500	142	70508200	146	71318600	105
70309207	104	70447200	144	70508400	146	71318700	105
70309208	104	70447400	144	70511000	151	71319000	105
70309209	104	70448200	144	70511200	151	71319100	105
70309210	104	70448400	144	70515200	148	71319200	105
70309211	104	70450000	150	70515400	148	71319300	105
70309212	104	70450400	150	70516200	148	71319400	105
70309213	104	70451000	150	70516400	148	71319500	105
70309214	104	70451400	150	70517200	148	71319600	105
70309215	104	70455200	147	70517400	148	71319700	105
70309216	104	70455400	147	70518200	148	72000000*	239
70309217	104	70456200	147	70518400	148	72000010	239
70309218	104	70456400	147	70521200	137	72010000*	240
70309219	104	70457200	147	70521400	137	72010010	240
70309220	104	70457400	147	70523200	139	72020000*	239
70309221	104	70458200	147	70523400	139	72020010	239
70309222	104	70458400	147	70526200	137	72040000*	237
70309223	104	70460200	136	70526400	137	72040010	237
70309224	104	70460400	136	70528200	139	72040100*	237
70309225	104	70461000	136	70528400	139	72040110	237
70309226	104	70461200	136	70700000	222	72041000*	237
70309227	104	70461400	136	70700100	222	72041010	237
70309228	104	70462200	138	70702000	223	72041100*	237
70309229	104	70462400	138	70702100	223	72041110	237

Niederlassungen und Vertretungen weltweit

Branches and Agencies worldwide

Etablissements et Représentants mondiaux

D

CONTACT GmbH
Gewerbestraße 30
70565 Stuttgart
Tel.: (+49) 7 11 - 78 38 - 03
Fax: (+49) 7 11 - 78 38 - 3 66
contact@contactconnectors.de
www.contact@contactconnectors.de

F

CONTACT France Sàrl
Technopôle Sud
57600 Forbach
Tel.: (+33) 3 87- 84 19 29
Fax: (+33) 3 87- 84 17 94

GB

CONTACT CONNECTORS Ltd.
733 Tudor Industrial Estate,
Abbey Road, Park Royal
London NW 10 7 UN
Tel.: (+44) 1 81- 4 53 01 99
Fax: (+44) 1 81- 4 53 87 01

IND

LAPP KABEL India Pvt Ltd.
Plot No. 98 J & K
Jigani Industrial Area, Phase II
Anekal Taluk
562106 Bangalore
Tel.: (+91) 80-42 63 27
Fax: (+91) 80-42 63 28

USA

CONTACT Electronics Inc.
38 Fairfield Place
West Caldwell, NJ 07006
Tel.: (+1) 9 73 - 5 75 76 60
Fax: (+1) 9 73 - 5 75 95 88
contactelectronics@att.net
www.contactelectronics.com

AUS

Multi-Contact Australia PTY Ltd.
55 Whiting Street
Artarmon NSW 2064
Tel.: (+61) 2 - 9 - 4 38 36 00
Fax: (+61) 2 - 9 - 4 38 47 37
mcontact@ozemail.com.au
www.multicontact.com.au

B

Lapp Kabel BVBA
Schietsdallaan 2 B.1
2300 Turnhout
Tel.: (+32) 14 - 43 64 43
Fax: (+32) 14 - 43 54 79

B

Bintz Technics N.V.
Brixtonlaan 25, Business Park
1930 Zaventem
Tel.: (+32) 2 - 7 20 49 16
Fax: (+32) 2 - 7 20 37 50
info@bintz-technics.de

DK

Miltronics A/S
Nimbusvej 5
P.O.Box 110
2670 Greve
Tel.: (+45) 43 95 00 00
Fax: (+45) 43 90 84 87

EST

Miltronics Eesti AS
P. O. Box 5319
EE - 0026 Tallinn
Tel.: (+372) 6 50 32 47
Fax: (+372) 6 50 32 46
rserg@online.ee

FIN

EI - Fresta OY AB
Kosini cables&components
Kiviadankatu 3
00210 Helsinki
Tel.: (+358) 9 - 34 80 72 - 0
Fax: (+358) 9 - 34 80 72 - 22
Elfresta@elfresta.fi

GR

PANAGIOTIS SP.
DIMOULAS - BIOMAT
Kritisstreet 26
10439 Athen
Tel.: (+30) 1- 8 83 33 37
Fax: (+30) 1- 8 83 44 36

HGK

Worldtex&Co.
Unit 05, 18/F, 113 Argyle Street
Kowloon/Hong Kong
Tel.: (+852) 27 81 18 60
Fax: (+852) 27 81 47 33

JL

Transelectric Ltd.
P.O. Box 3261,
88 Gisin St., Kiryat Arye
49130 Petach-Tikva
Tel.: (+972) 3 - 9 24 36 81
Fax: (+972) 3 - 9 24 50 38
sales@transelectric.co.il
www.transelectric.co.il

I

Reiter Srl.
Viale Lombardia 51
20047 Brugherio
Tel.: (+39) 039 - 28 91 31
Fax: (+39) 039 - 88 47 17
Reiter@tin.it

J

K. Mecs Co. Ltd.
Sudacho Verde Bldg.
3 Kanda Sudacho 2 - CHOME
Chiyodaku, Tokyo 101
Tel.: (+81) 3 - 52 95 31 11
Fax: (+81) 3 - 52 95 31 23
kmecs@mx.mesh.ne.jp
www.kmecs.com

LV

Miltronics LAT SIA
Darzauglu 12
RIGA LV-1012 / Latvia
Tel.: (+371) 7 31 10 37
Fax: (+371) 7 31 14 28

LT

Miltronics UAB
P. O. Box 157
A. Vienuolio 12-16
2000 Vilnius / Lithuania
Tel.: (+370) 2-22 59 82
Fax: (+370) 2-22 59 82
miltronics@post.omnitel.net

MEX

LAPP Mexico
Col. Industrial El Alamo
Metalurgia # 2730
Mex - 44490 Tlaquepaque, Jalisco
Tel.: (+52) 3-6 70 50 61
Fax: (+52) 3-6 70 86 28
www.olflex.com.mx

NL

Lapp Kabel B.V.
Postbus 2105
Re Run 4326
5503 NZ Veldhoven
Tel.: (+31) 40 - 2 54 54 65
Fax: (+31) 40 - 2 54 14 45
sales@lappkabel.nl

NL

Distributor
Brinkman & Germeraad BV
Effect 5
6921 RG Duiven
Tel.: (+31) 26 - 3 65 29 11
Fax: (+31) 26 - 3 65 23 90
inkoop@bengl.nl
www.bengl.nl

N

Miltronics A/S
Dolasletta 5
P.O. Box 25
3408 Tranby
Tel.: (+47) 32 22 66 10
Fax: (+47) 32 22 66 56

A

Lapp Kabel GmbH
Flachenuergutstraße 6
4020 Linz
Tel.: (+43) 7 32 - 78 12 72
Fax: (+43) 7 32 - 78 12 72 33

P

Policabos S.A.
Solucoes Técnicas de Condutores, S.A.
Rua Maria Lamas,
Lote 19 - Bloco B - Piso 1
Serra das Minas
2735 Rio de Mouro
Tel.: (+351) 1 - 9 17 86 40
Fax: (+351) 1 - 9 17 86 49
Policabos@mail.telepac.pt

ROK

Thomas Trading Co., Ltd.
C-3201, 889-1 Kwanyang 2-Dong,
AYANG-SI, Kyungi-Do, ROK
Tel.: (+82) 3 43 - 4 24 83 00
Fax: (+82) 3 43 - 4 24 83 11
Thomas33@chollian.dacom.kr

S

Miltronics AB
Kungshagsvaegen 9
P.O. Box 1022
61129 Nykoeping
Tel.: (+46) 1 55 - 7 77 00
Fax: (+46) 1 55 - 28 73 16
info@miltronics.se
www.miltronics.se

CH

Bachofen AG
Ackerstraße 42
8610 Uster
Tel.: (+41) 1 - 9 44 11 11
Fax: (+41) 1 - 9 44 12 33
info@bachofen.ch
www.bachofen.ch

CH

Bachofen AG
Route de Prilly 25
1023 Crissier
Tel.: (+41) 21 - 6 37 21 70
Fax: (+41) 21 - 6 37 21 99

SGP

LAPP Logistics Pte.Ltd.
No. 2 Clementi Loop
01-02 Moreton Logistics Centre
Singapore 129809
Tel.: (+65) 4 67 77 77
Fax: (+65) 4 67 20 75

SLO

FINEA Trade D.O.O.
Kraljevica Marka 5
2000 Maribor
Tel.: (+386) 62 22 33 19
Fax: (+386) 62 22 33 19

ZA

Powermite Africa PTY Ltd.
Powermite House
92, Main Reef Road
P.O. Box 7745
2000 Johannesburg
Tel.: (+27) 11 - 7 60 19 19
Fax: (+27) 11 - 7 60 30 99
powermite.jhb@global.co.za
www.powermite.co.za

E

SINTER S.A.
C/Marqués de
Monteagudo 24-2A
28028 Madrid
Tel.: (+34) 91 - 3 61 00 41
Fax: (+34) 91 - 7 25 17 45
sintersa@arrakis.es

CZ

LAPP Kabel s.r.o.
Tovarni 1333
76901 Holesov
Tel.: (+420) 6 35 - 39 46 48
Fax: (+420) 6 35 - 39 46 50

TR

Lapp Kablo
Sanayi Ve Ticaret Limited Sirketi
Izeltas Galeria
Bornova Cad., No. 7 / 32 + 33
35070 Izmir-Isikkent
Tel.: (+90) 232 - 4 36 38 - 72
Fax: (+90) 232 - 4 36 38 - 76
lappkabl@efes.net.tr

YV

Klöckner-Moeller Somernica C.A.
Calle Vargas Edif. Esteban
Piso 2 Bol. Norte
Apartado 76051
Caracas 1070
Tel.: (+58) 2 35 27 48
Fax: (+58) 2 38 56 25
www.kmsomerinca.com.ve

VRC

AMLINK Int. Trading
(Shanghai) Co., Ltd.
Rm 717, East-China Financial Bld.
28 Ma Ji Road, Pudong, Shanghai
PR China 200131
Tel.: (+86) 21-58 69 61 08
Fax: (+86) 21-58 69 10 25
amlink@guomai.sh.cn

MY

Jebsen&Jessen I.P. (Malaysia)
Sdn Bnd
16 Jalan 51 A/225
46100 Petaling Jaya, Selangor
Tel.: (+60) 3-776 9333
Fax: (+60) 3-773 1033

TH

Jebsen and Jessen Engineering (T) Ltd.
26 th. Floor, Sorachai Building
23/110-113 Sukhumvit Soi 63
(Ekkamai)
Klongtoey, Bangkok 10250
Tel.: (+66) 2-7 14 39 39
Fax: (+66) 2-7 14 39 49

PH

Jebsen&Jessen Philippines Inc.
Main Avenue, Severina Diamond
Industrial Estate
West Service Road, KM 16 South
Expressway Parangue 1700,
Metro Manila
Tel.: (+63) 2-8 22 25 02
Fax: (+63) 2-8 22 25 01

A

C

L

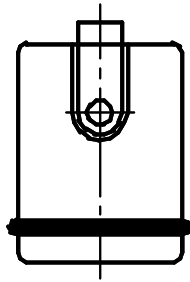

M

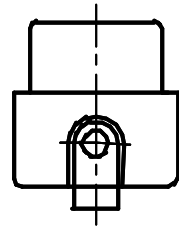
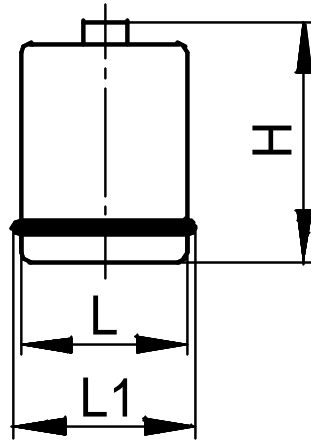

F

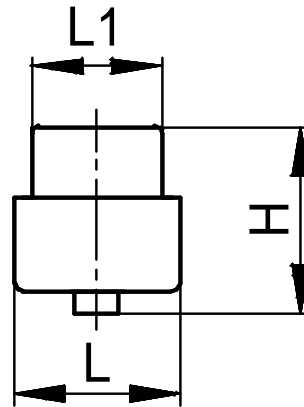

KAE-1000-60

view from cable side

M

F

M

F

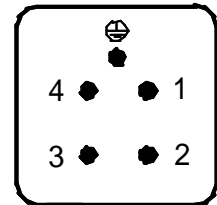
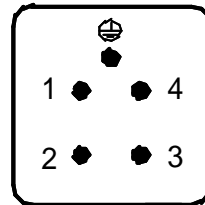
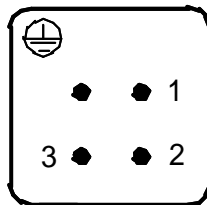
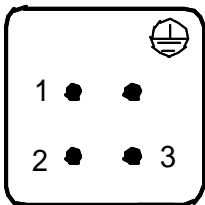

KAE-1003-20

A

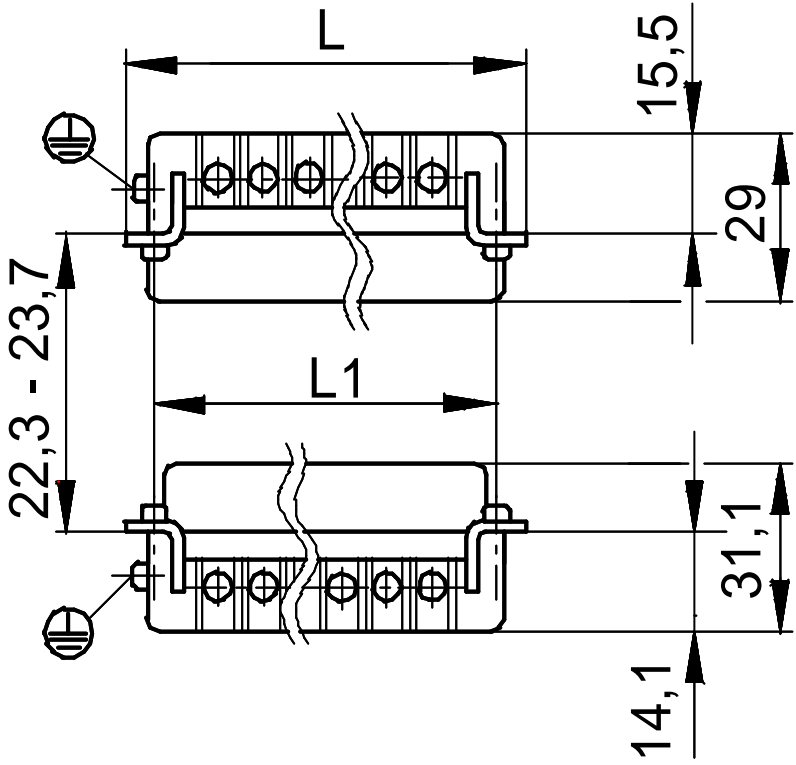

C

L

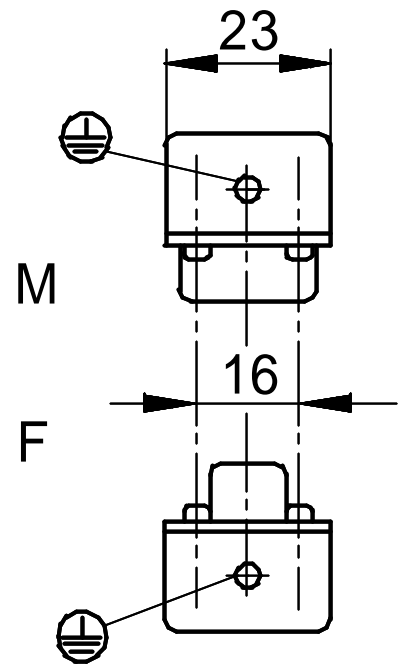

KAE-1100-60

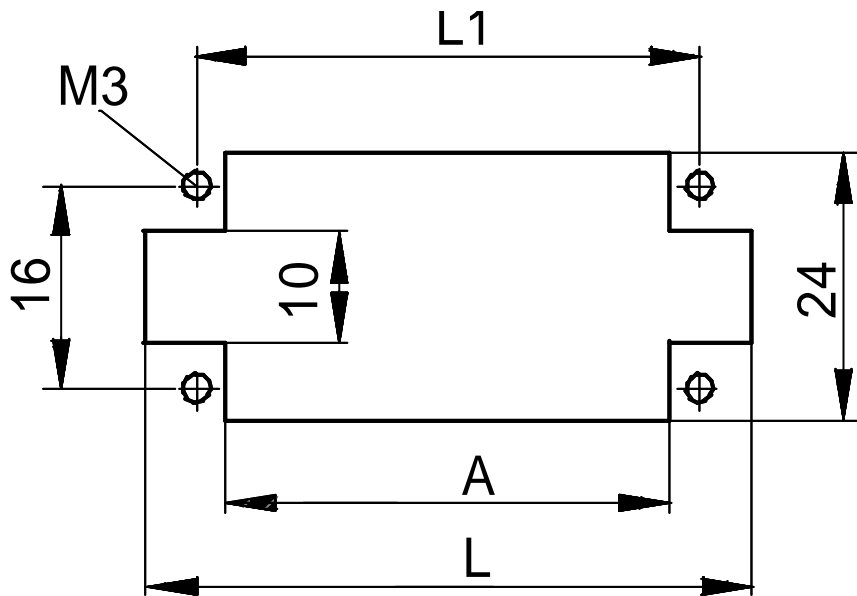

KAE-1000-30

A

C

L

view from cable side

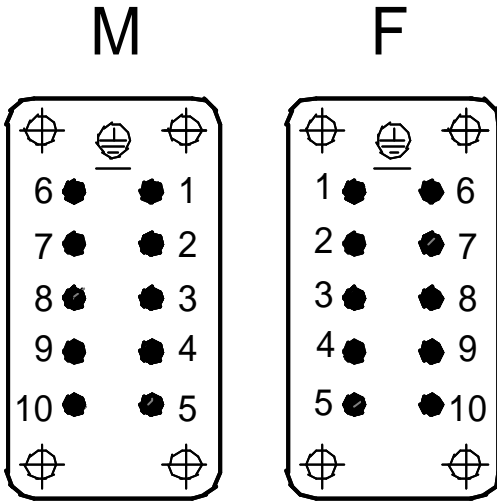

view from cable side

KBE-3010-20

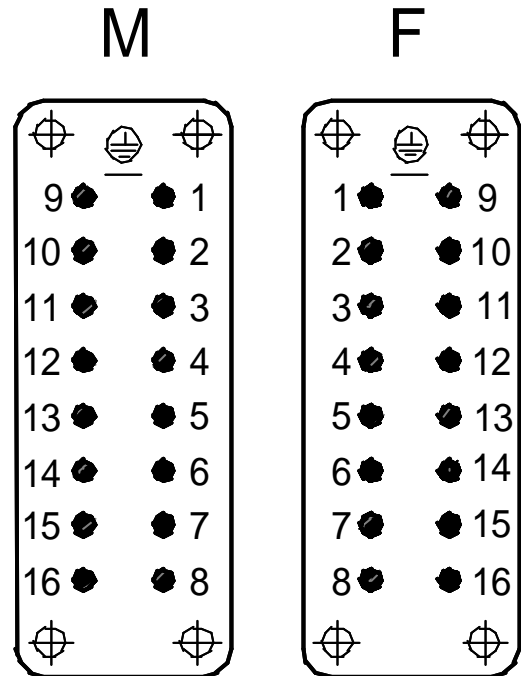

KBE-3016-20

A

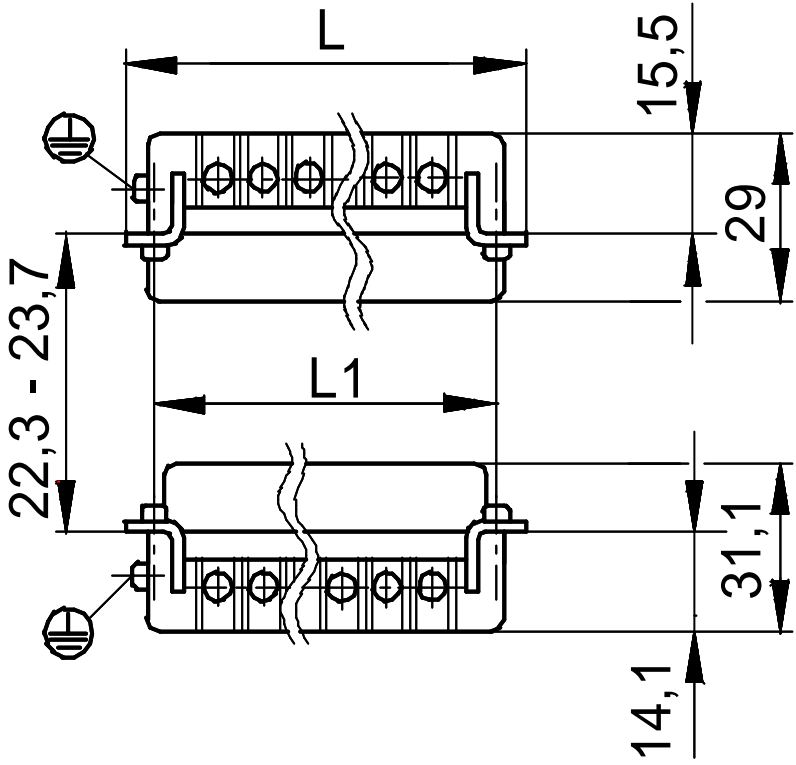

C

L

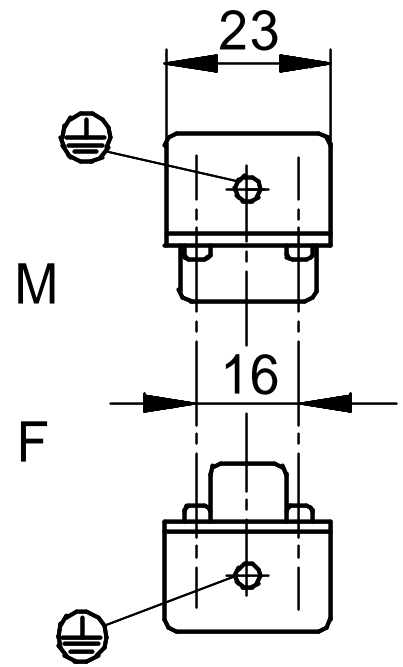

KAE-1100-60

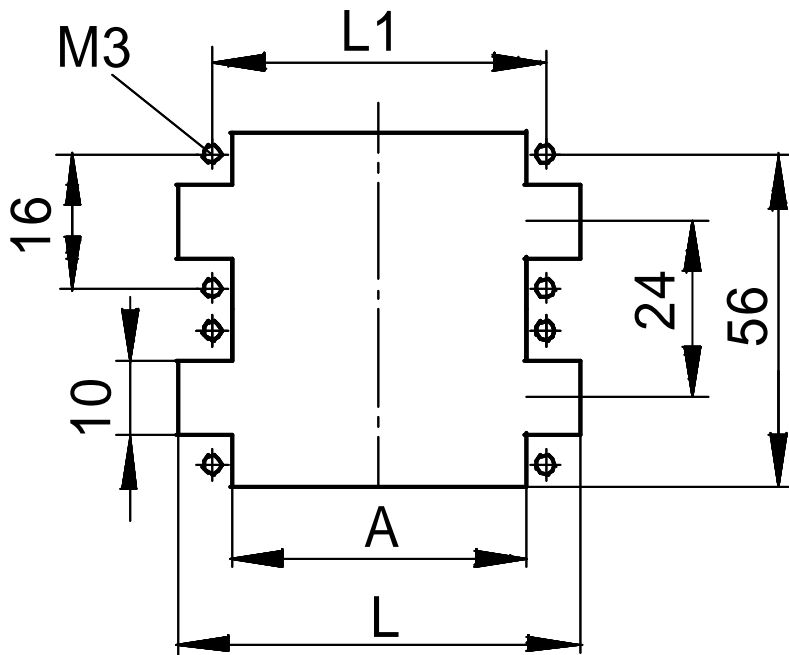

KAE-1100-30

A

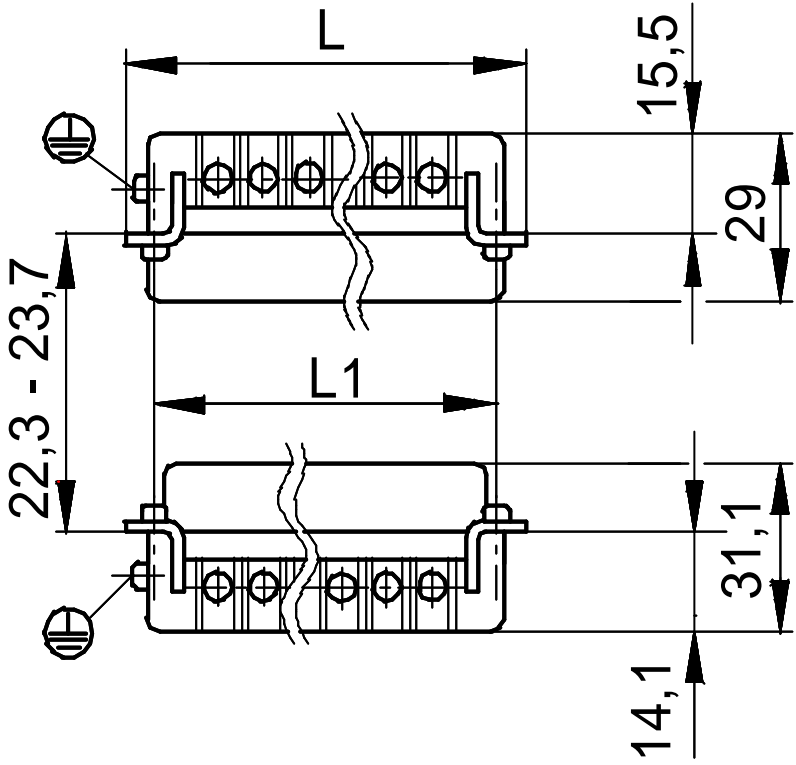

C

L

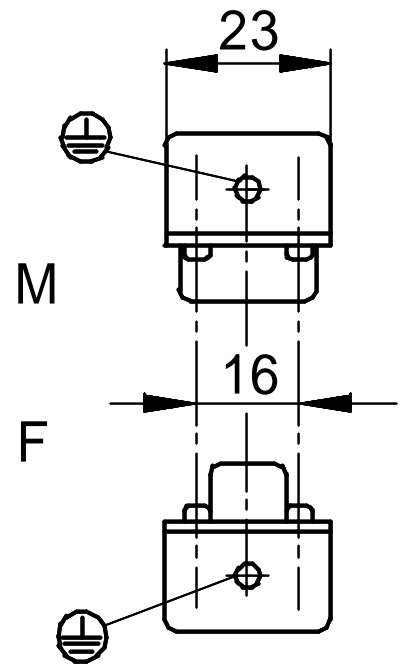

KAE-1100-60

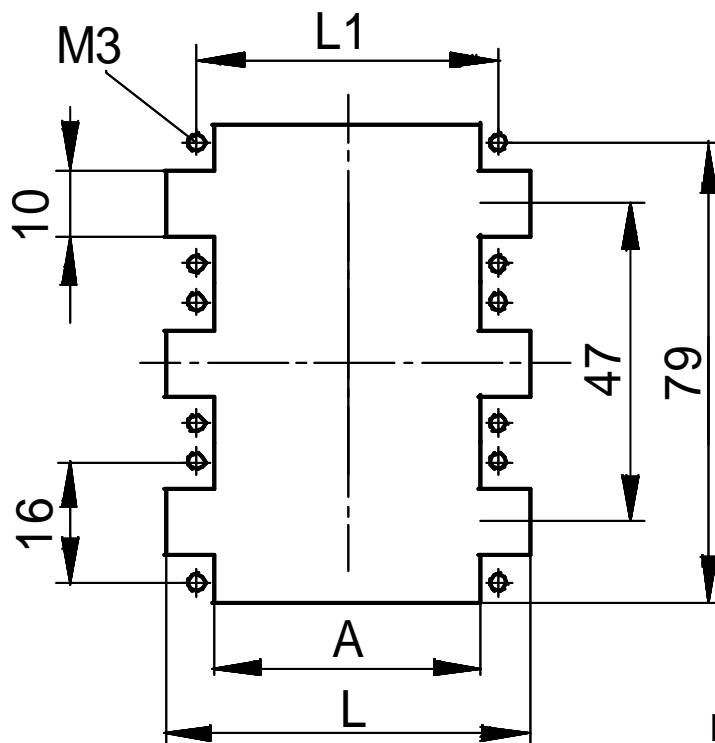

KAE-1200-30

A

C

L

view from cable side

M

F

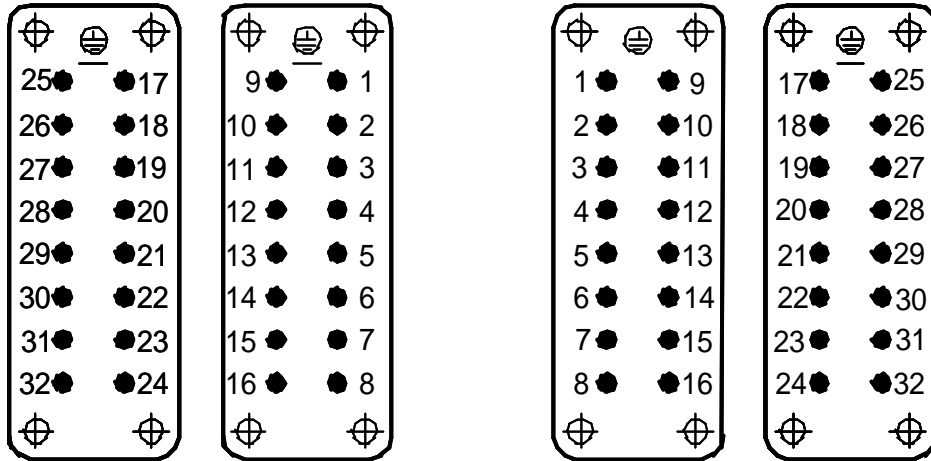

KBE-3032-20

view from cable side

M

F

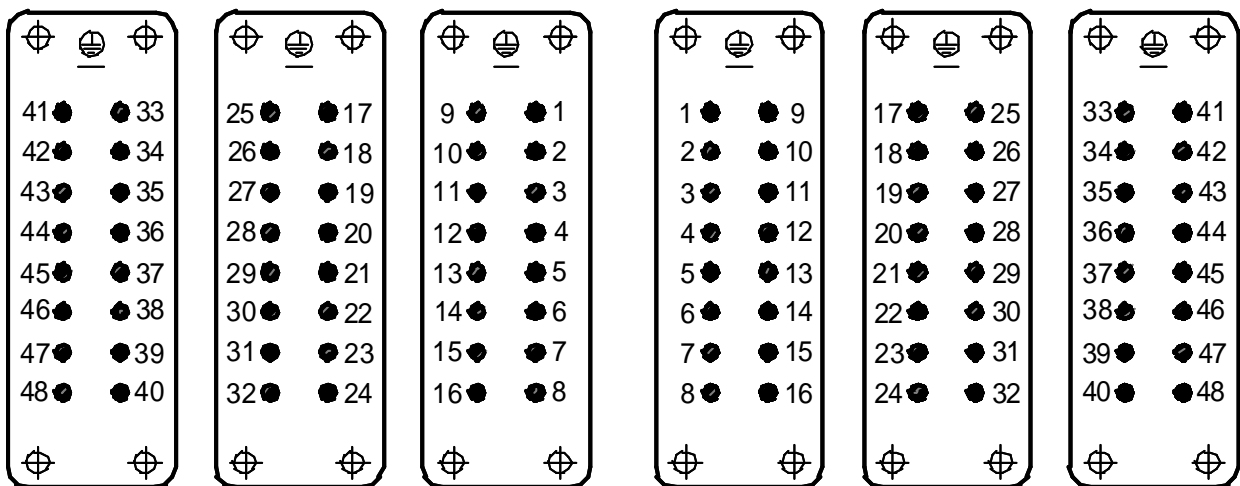

KAE-1048-20

A

C

L

Benennung	Art. Nr.	Version	Kontakte	L	L1	A / H	Bild Nr.	Bild Nr.	Bild Nr.
Description	part No.	version	contacts	L	L1	A / H	picture No.	picture No.	picture No.
Désignation	N° art.	version	contacts	L	L1	A / H	page N°	page N°	page N°
H-A 3 SS	10420000	Male	3 + PE	21	23,3	26,3	KAE-1000-60	KAE-1003-20	
H-A 3 BS	10421000	Female	3 + PE	21	14,0	25,5	KAE-1000-60	KAE-1003-20	
H-A 4 SS	10431000	Male	4 + PE	21	23,6	32,5	KAE-1000-60	KAE-1004-20	
H-A 4 BS	10432000	Female	4 + PE	21	16,7	31,8	KAE-1000-60	KAE-1004-20	
H-A 10 SS wire protection	10440100	Male	10	56,5	49,5	42,5	KAE-1100-60	KAE-1000-30	KBE-3010-20
H-A 10 BS wire protection	10441100	Female	10	56,5	49,5	42,5	KAE-1100-60	KAE-1000-30	KBE-3010-20
H-A 10 SS	10440000	Male	10	56,5	49,5	42,5	KAE-1100-60	KAE-1000-30	KBE-3010-20
H-A 10 BS	10441000	Female	10	56,5	49,5	42,5	KAE-1100-60	KAE-1000-30	KBE-3010-20
H-A 16 SS wire protection	10530000	Male	16	73	66	60	KAE-1100-60	KAE-1000-30	KBE-3016-20
H-A 16 BS wire protection	10531000	Female	16	73	66	60	KAE-1100-60	KAE-1000-30	KBE-3016-20
H-A 16 SS	10532000	Male	16	73	66	60	KAE-1100-60	KAE-1000-30	KBE-3016-20
H-A 16 BS	10533000	Female	16	73	66	60	KAE-1100-60	KAE-1000-30	KBE-3016-20
H-A 16 SS wire protection 1-16	10530000	Male	16	73	66	60	KAE-1100-60	KAE-1100-30	KBE-3032-20
H-A 16 SS wire protection 17-32	10540000	Male	16	73	66	60	KAE-1100-60	KAE-1100-30	KBE-3032-20
H-A 16 BS wire protection 1-16	10531000	Female	16	73	66	60	KAE-1100-60	KAE-1100-30	KBE-3032-20
H-A 16 BS wire protection 17-32	10541000	Female	16	73	66	60	KAE-1100-60	KAE-1100-30	KBE-3032-20
H-A 16 SS 1-16	10532000	Male	16	73	66	60	KAE-1100-60	KAE-1100-30	KBE-3032-20
H-A 16 SS 17-32	10542000	Male	16	73	66	60	KAE-1100-60	KAE-1100-30	KBE-3032-20
H-A 16 BS 1-16	10533000	Female	16	73	66	60	KAE-1100-60	KAE-1100-30	KBE-3032-20
H-A 16 BS 17-32	10543000	Female	16	73	66	60	KAE-1100-60	KAE-1100-30	KBE-3032-20
H-A 16 SS wire protection 1-16	10530000	Male	16	73	66	60	KAE-1100-60	KAE-1200-30	KAE-1048-20
H-A 16 SS wire protection 17-32	10540000	Male	16	73	66	60	KAE-1100-60	KAE-1200-30	KAE-1048-20
H-A 16 SS wire protection 33-48	10540100	Male	16	73	66	60	KAE-1100-60	KAE-1200-30	KAE-1048-20
H-A 16 BS wire protection 1-16	10531000	Female	16	73	66	60	KAE-1100-60	KAE-1200-30	KAE-1048-20
H-A 16 BS wire protection 17-32	10541000	Female	16	73	66	60	KAE-1100-60	KAE-1200-30	KAE-1048-20
H-A 16 BS wire protection 33-48	10541100	Female	16	73	66	60	KAE-1100-60	KAE-1200-30	KAE-1048-20
H-A 16 SS 1-16	10532000	Male	16	73	66	60	KAE-1100-60	KAE-1200-30	KAE-1048-20
H-A 16 SS 17-32	10542000	Male	16	73	66	60	KAE-1100-60	KAE-1200-30	KAE-1048-20
H-A 16 SS 33-48	10542100	Male	16	73	66	60	KAE-1100-60	KAE-1200-30	KAE-1048-20
H-A 16 BS 1-16	10533000	Female	16	73	66	60	KAE-1100-60	KAE-1200-30	KAE-1048-20
H-A 16 BS 17-32	10543000	Female	16	73	66	60	KAE-1100-60	KAE-1200-30	KAE-1048-20
H-A 16 BS 33-48	10543100	Female	16	73	66	60	KAE-1100-60	KAE-1200-30	KAE-1048-20

A

C

L

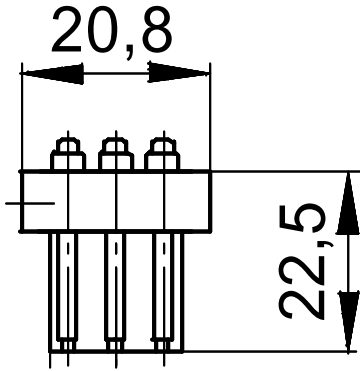

M

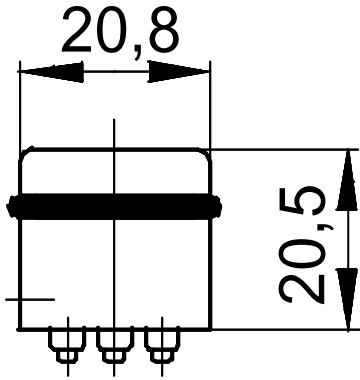
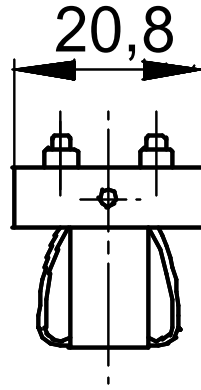

F

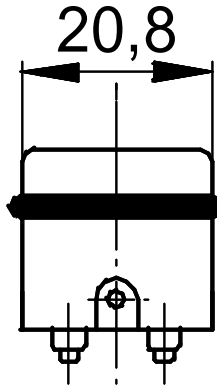

KAE-7000-60

view from cable side

STA-F

STA-S

M

F

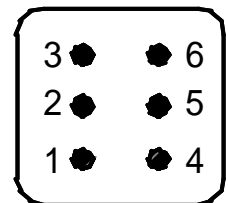
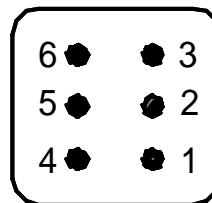

KAE-7006-20

A

C

L

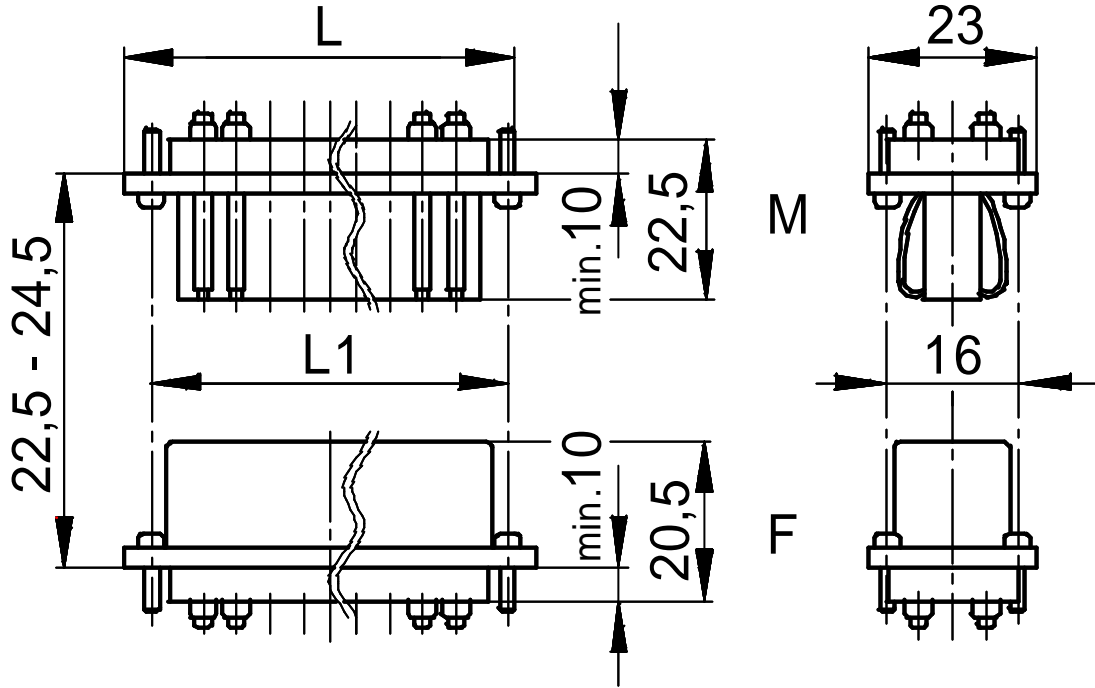

KAE-7005-60

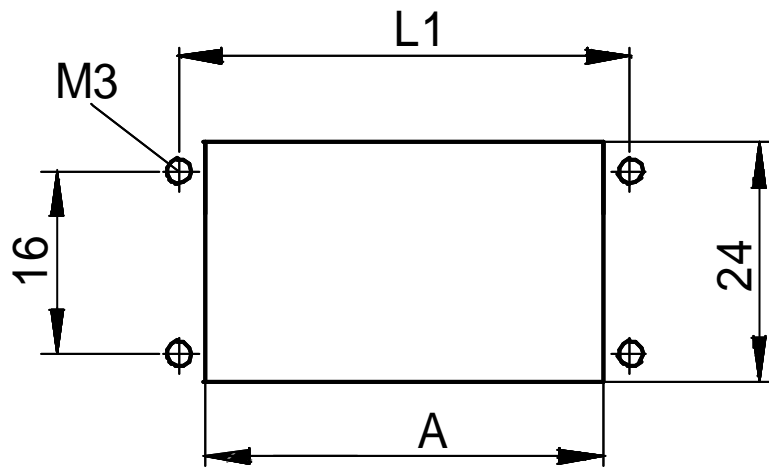

KAE-7000-30

A

C

L

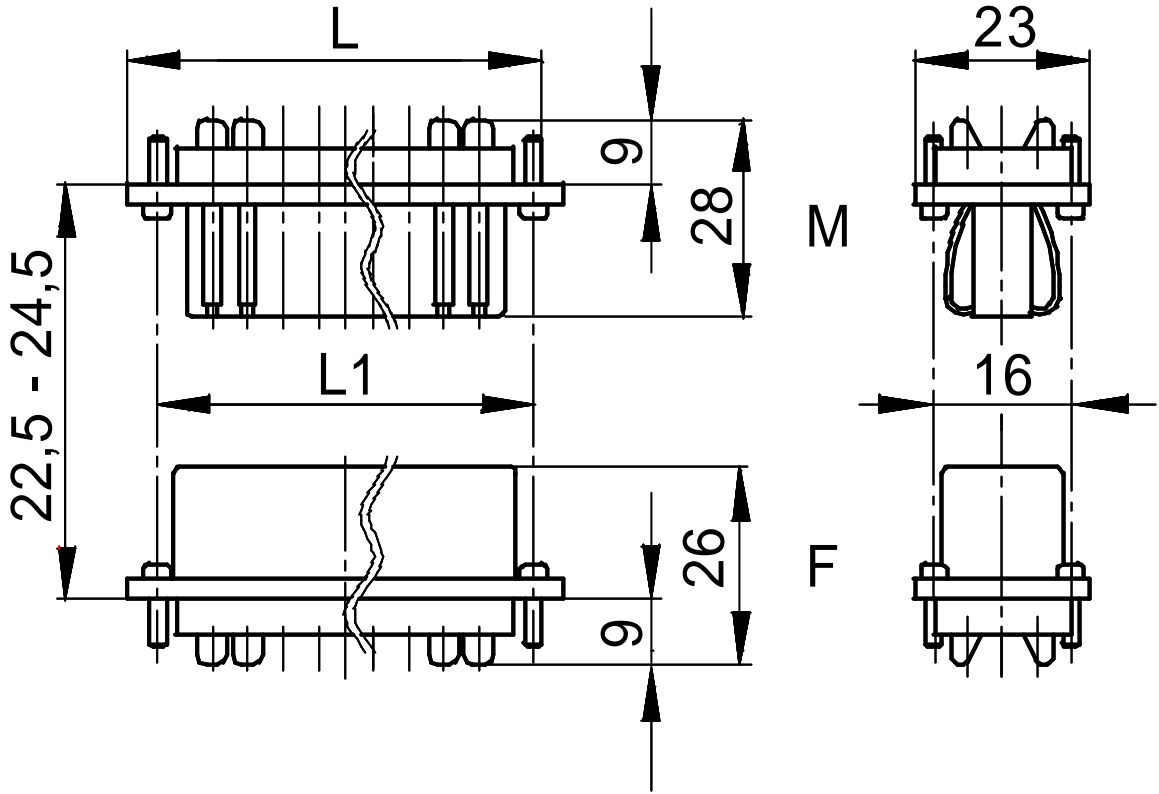

KAE-7505-60

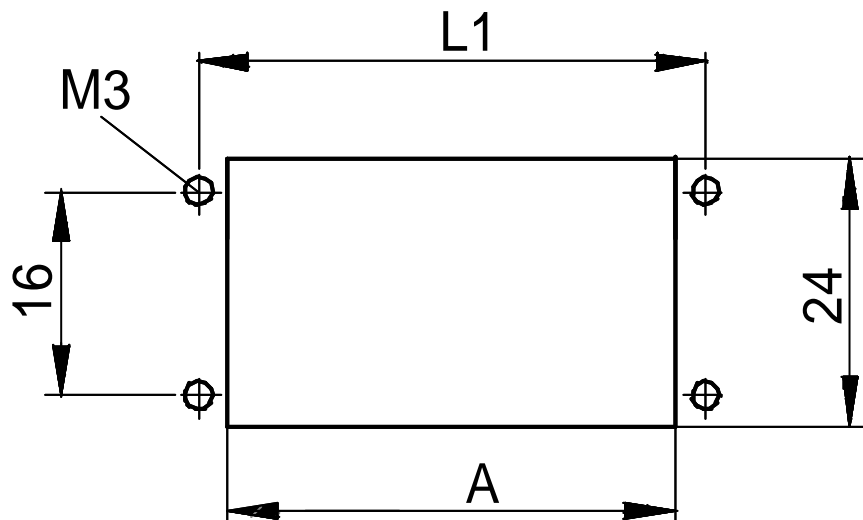

KAE-7000-30

A

C

L

view from cable side

M

F

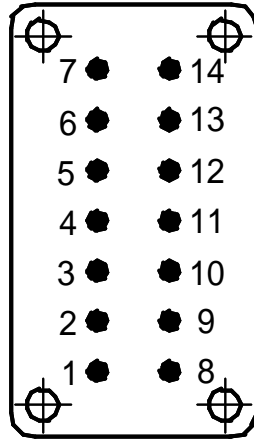
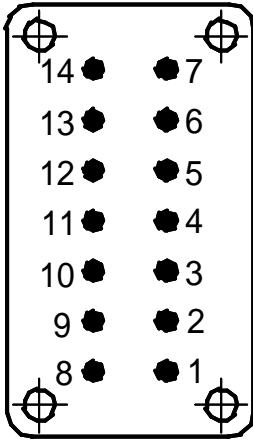

KAE-7014-20

view from cable side

M

F

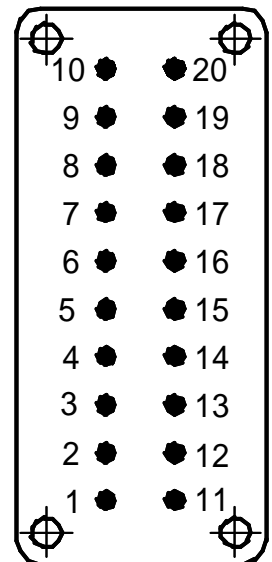
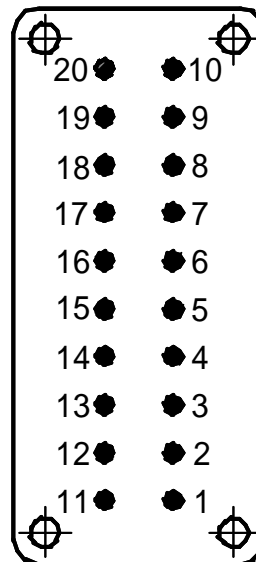

KAE-7020-20

A

C

L

Benennung	Art. Nr.	Version	Kontakte				Bild Nr.	Bild Nr.	Bild Nr.
Description	part No.	version	contacts	L	L1	A	picture No.	picture No.	picture No.
Désignation	N° art.	version	contacts				page N°	page N°	page N°
STA 6 F S Male	10488100	male	6	-	-	-	KAE-7000-60	KAE-7006-20	-
STA 6 S S Female	10486100	female	6	-	-	-	KAE-7000-60	KAE-7006-20	-
STA 6 F L Male	10487200	male	6	-	-	-	KAE-7000-60	KAE-7006-20	-
STA 6 S L Female	10485200	female	6	-	-	-	KAE-7000-60	KAE-7006-20	-
STA 14 F S Male	10493100	male	14	56,5	49,5	41,5	KAE-7005-60	KAE-7000-30	KAE-7014-20
STA 14 S S Female	10491100	female	14	56,5	49,5	41,5	KAE-7005-60	KAE-7000-30	KAE-7014-20
STA 14 F L Male	10492200	male	14	56,5	49,5	41,5	KAE-7505-60	KAE-7000-30	KAE-7014-20
STA 14 S L Female	10490200	female	14	56,5	49,5	41,5	KAE-7505-60	KAE-7000-30	KAE-7014-20
STA 20 F S Male	10503100	male	20	73	66	58	KAE-7005-60	KAE-7000-30	KAE-7020-20
STA 20 S S Female	10501100	female	20	73	66	58	KAE-7005-60	KAE-7000-30	KAE-7020-20
STA 20 F L Male	10502200	male	20	73	66	58	KAE-7505-60	KAE-7000-30	KAE-7020-20
STA 20 S L Female	10500200	female	20	73	66	58	KAE-7505-60	KAE-7000-30	KAE-7020-20

A

C

L

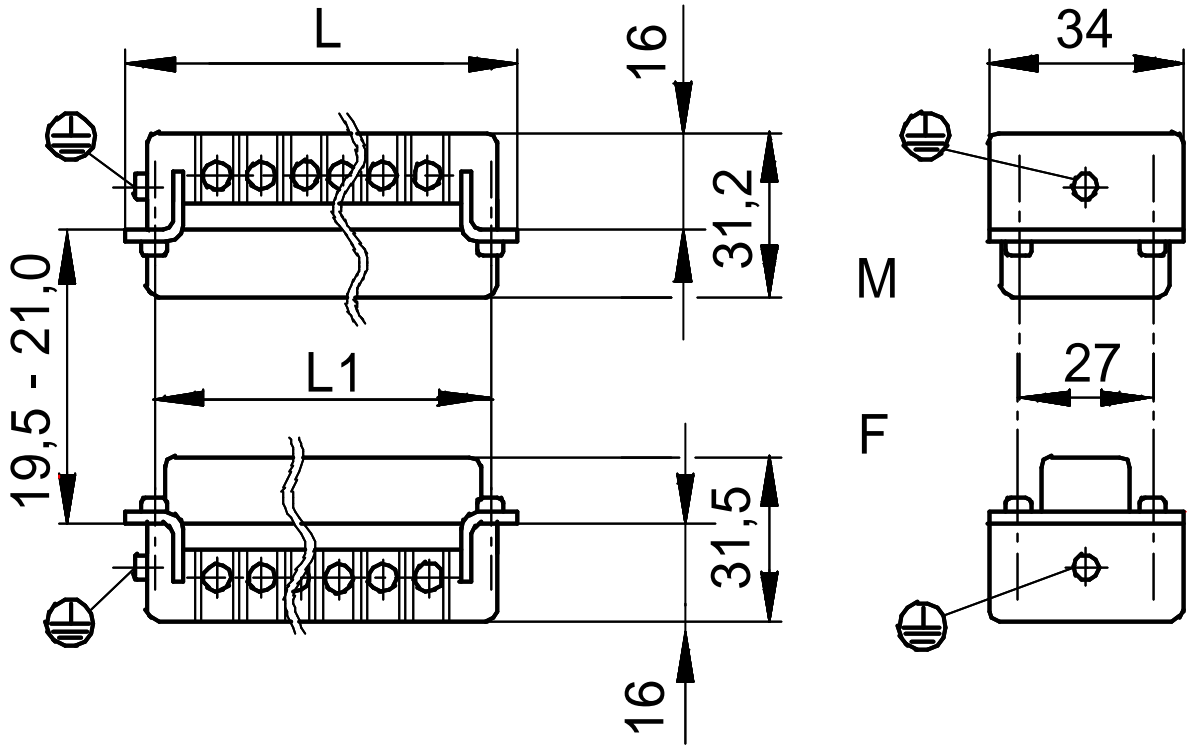

KBE-1000-60

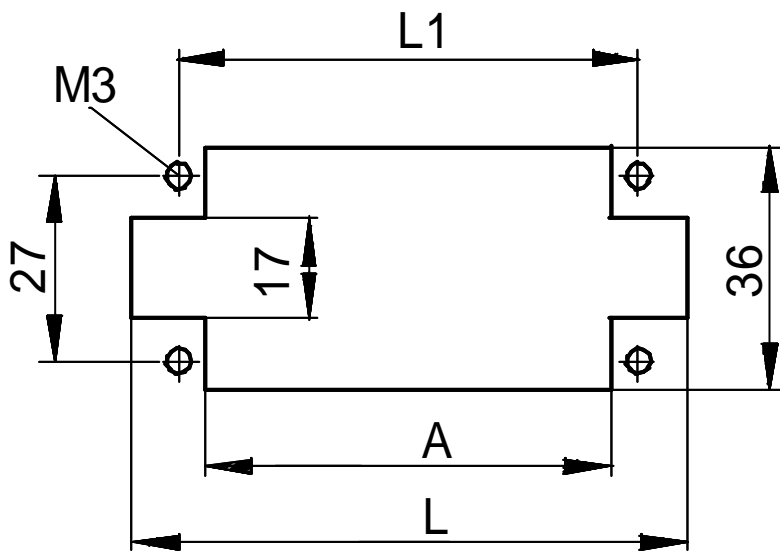

KBE-1000-30

A

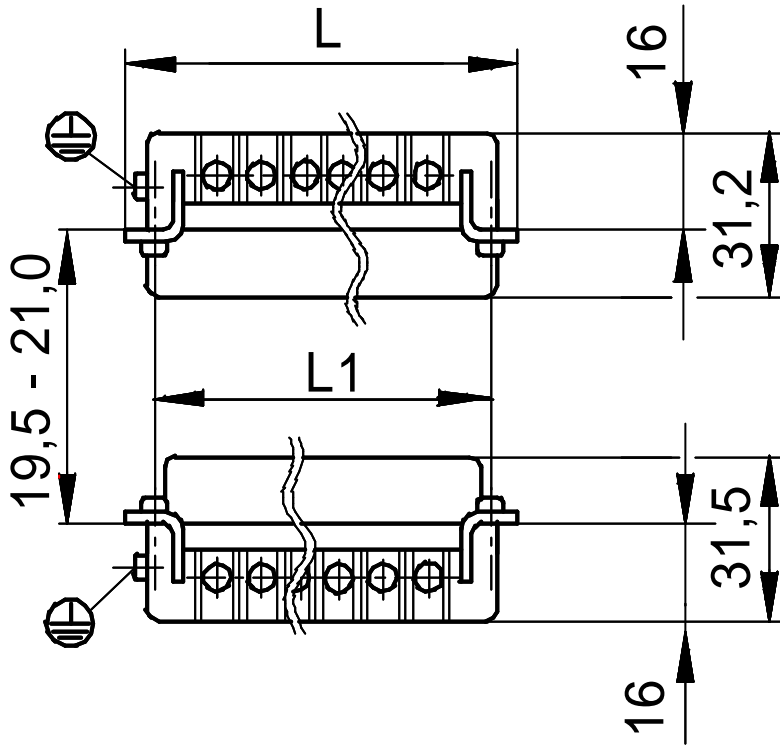

KBE-1000-60

C

L

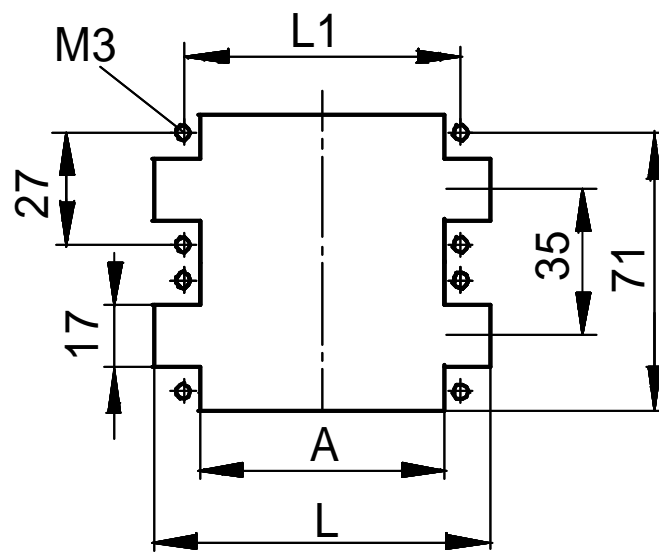
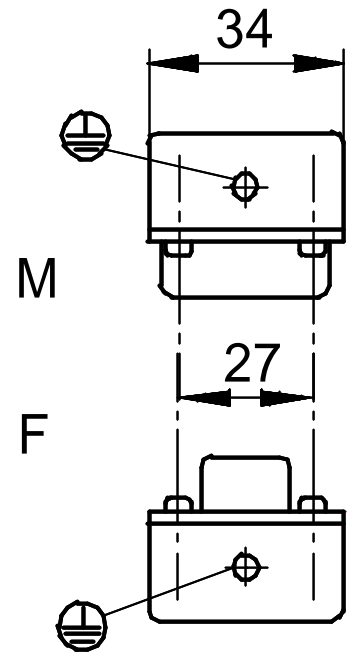

KBE-1100-30

A

C

L

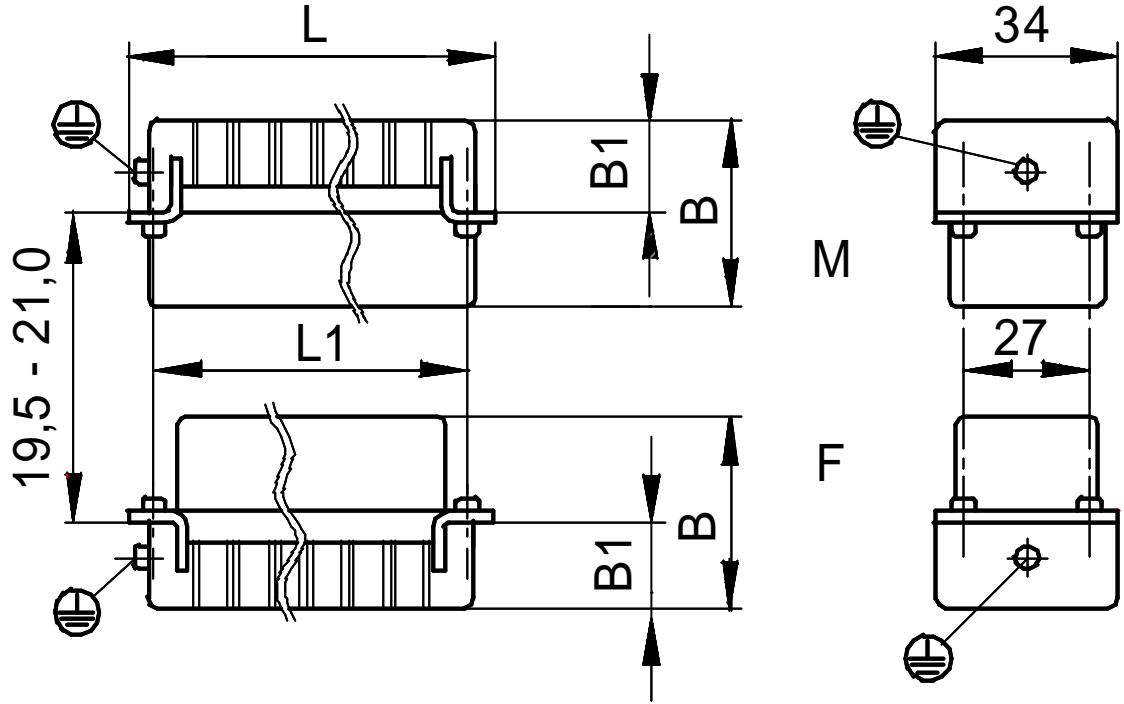

KBE-3000-60

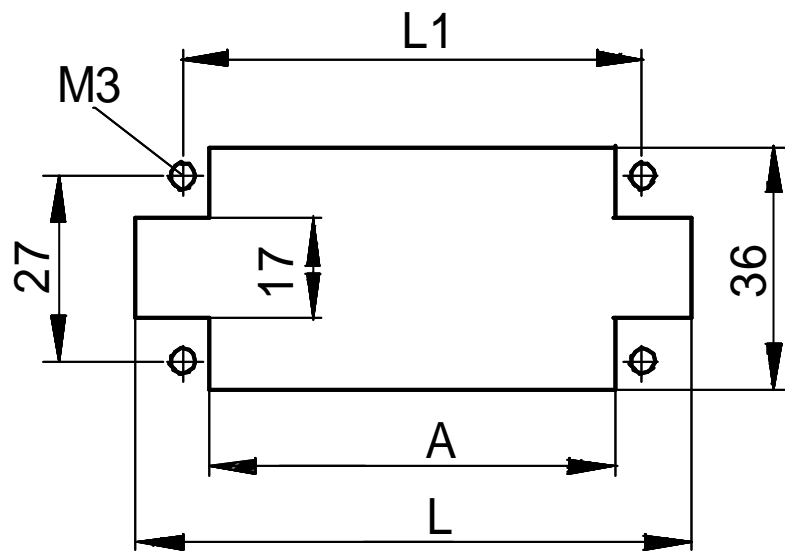

KBE-1000-30

A

C

L

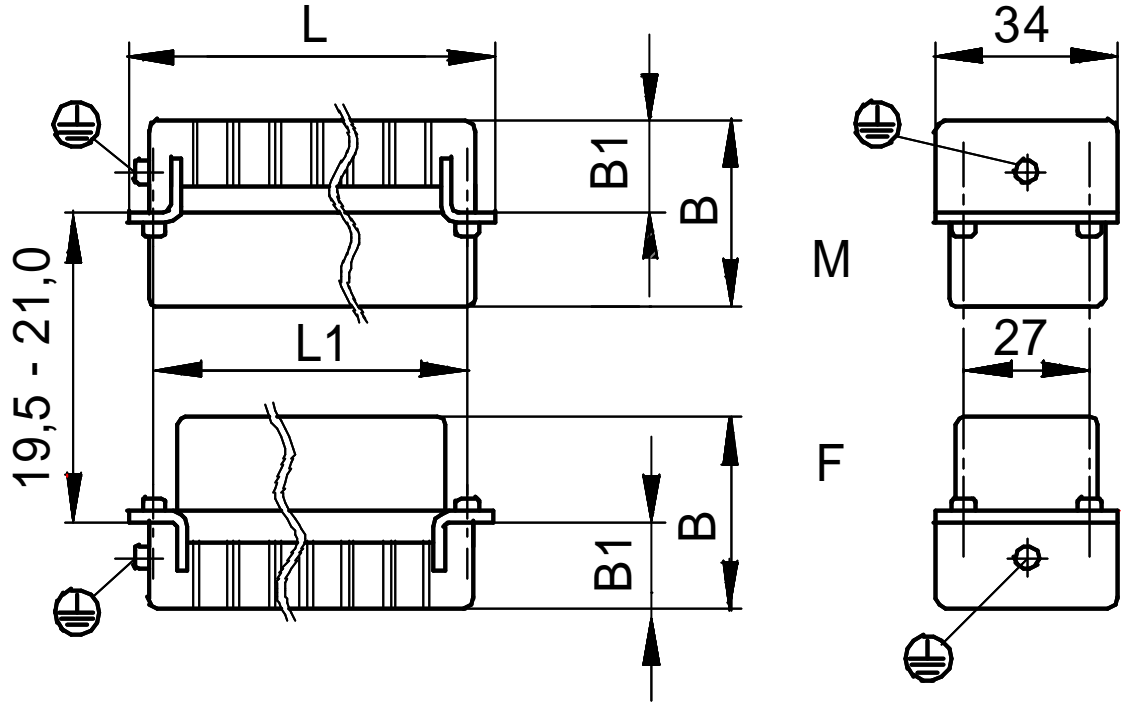

KBE-3000-60

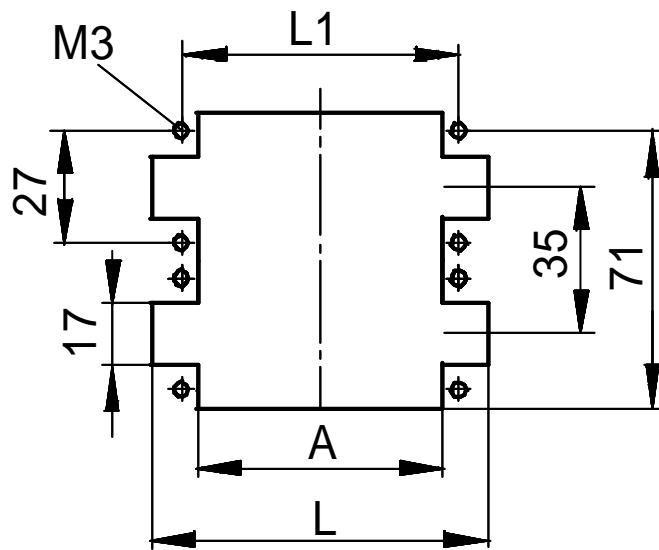

KBE-1100-30

A

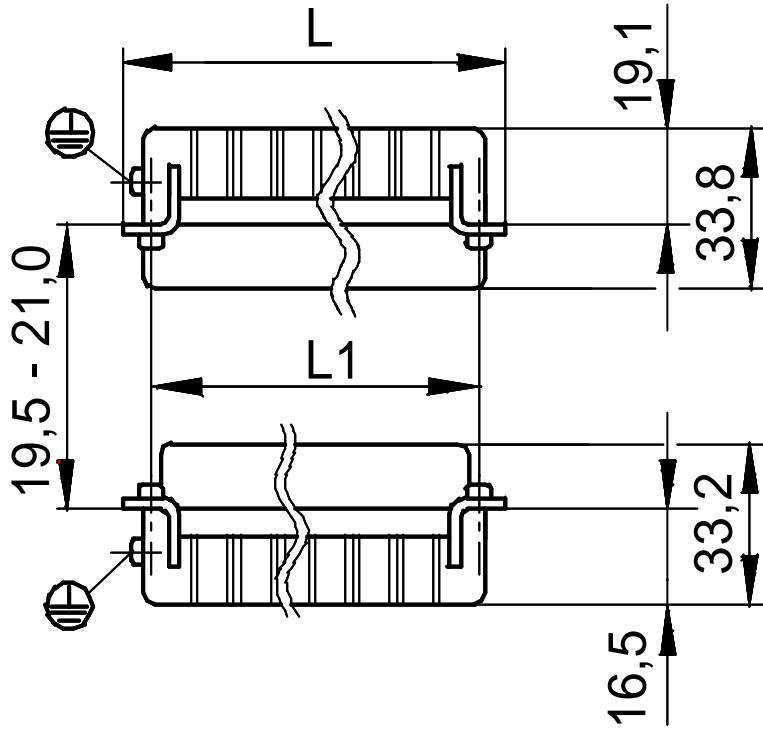

KBE-5000-60

C

L

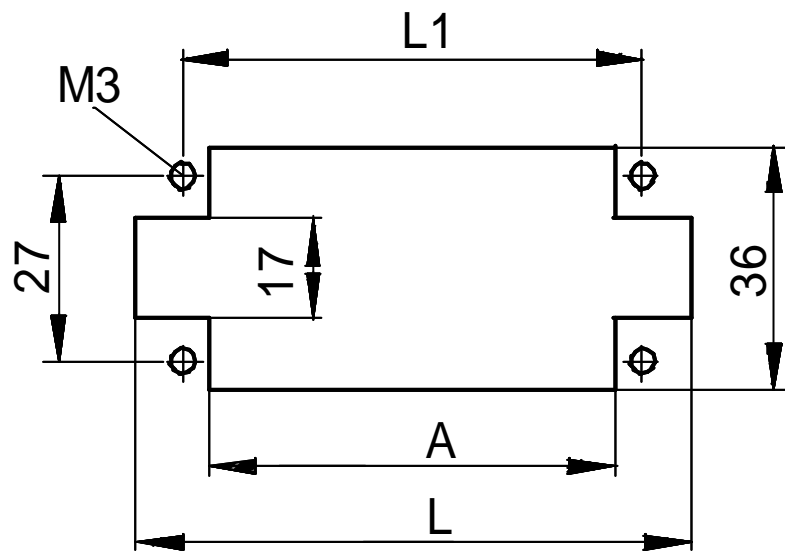
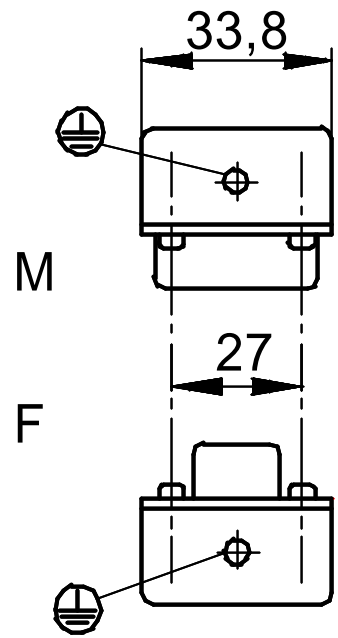

KBE-1000-30

A

C

L

view from cable side

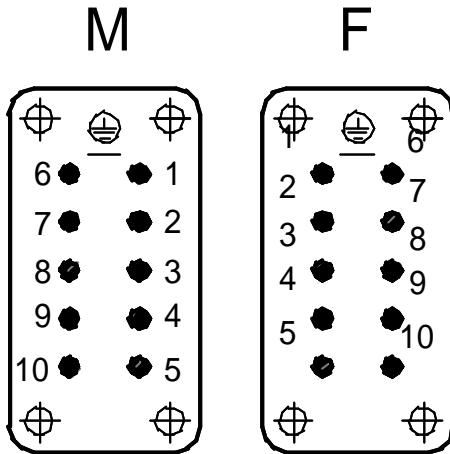

KBE-3010-20

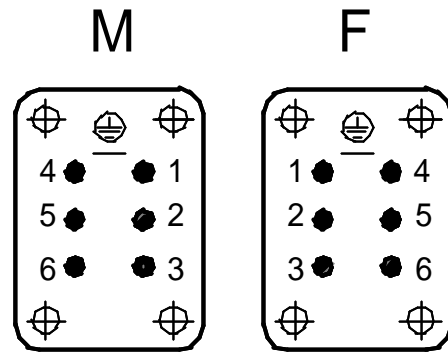

KBE-3006-20

view from cable side

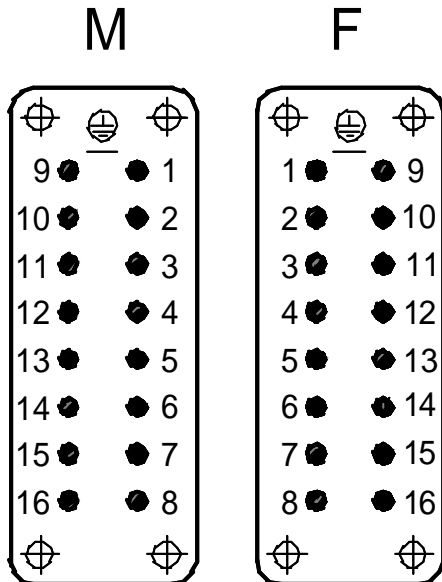

KBE-3016-20

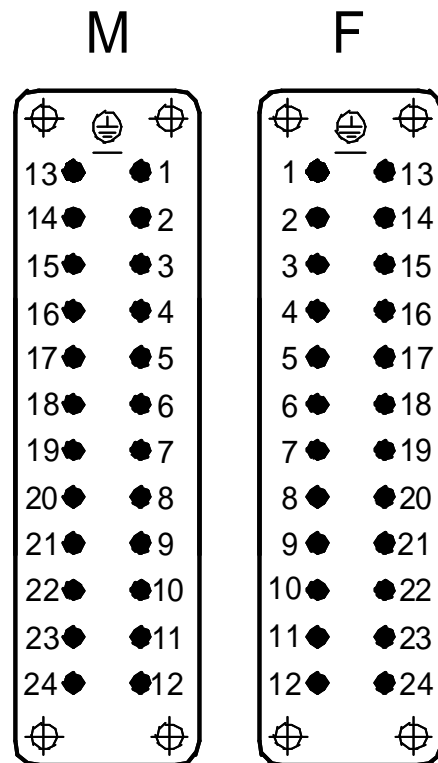

KBE-3024-20

A

C

L

view from cable side

M

F

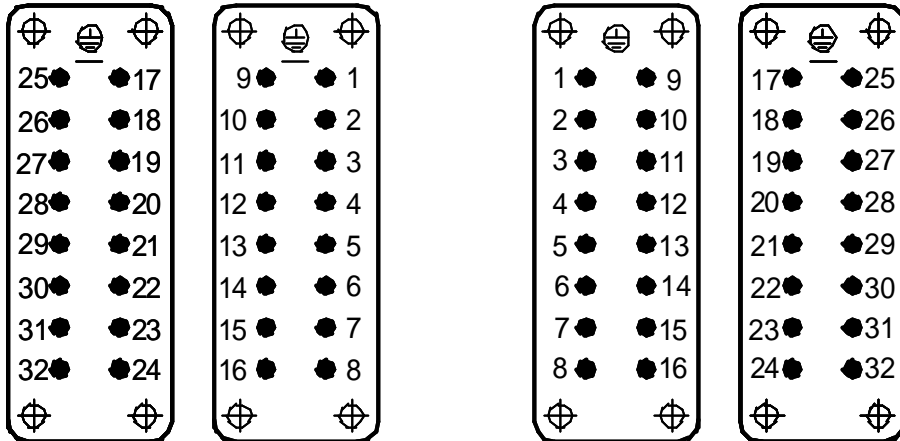

KBE-3032-20

view from cable side

M

F

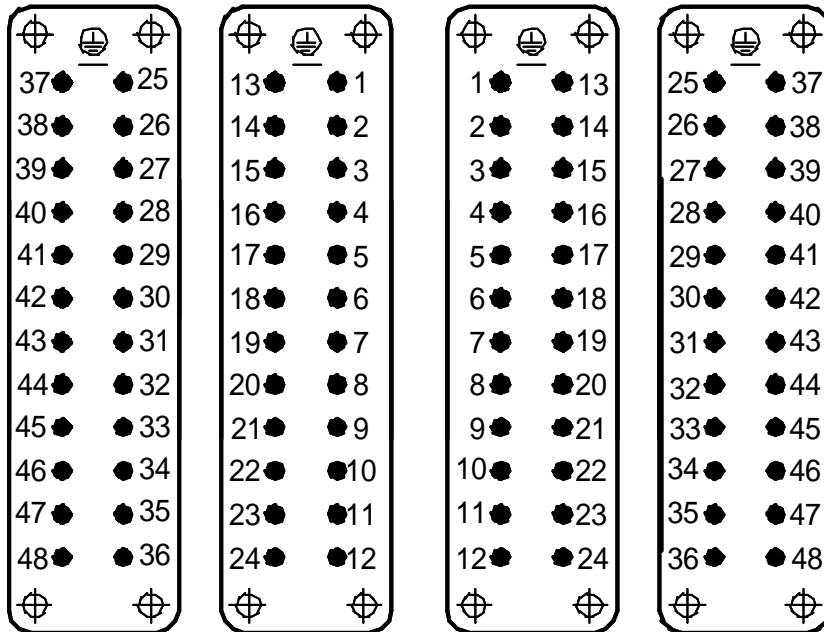

KBE-3048-20

A

C

L

Benennung	Art. Nr.	Version	Kontakte	L	L1	A	B	B1	Bild Nr.	Bild Nr.	Bild Nr.
Description	part No.	version	contacts	L	L1	A	B	B1	picture No.	picture No.	picture No.
Désignation	N° art.	version	contacts	L	L1	A	B	B1	page N°	page N°	page N°
H-BE 6 SS wire protection	10190000	screw	6	51	44	39			KBE-1000-60	KBE-1000-30	KBE-3006-20
H-BE 6 BS wire protection	10191000	screw	6	51	44	39			KBE-1000-60	KBE-1000-30	KBE-3006-20
H-BE 6 SS	10190100	screw	6	51	44	39			KBE-1000-60	KBE-1000-30	KBE-3006-20
H-BE 6 BS	10191100	screw	6	51	44	39			KBE-1000-60	KBE-1000-30	KBE-3006-20
H-BE 10 SS wire protection	10192000	screw	10	64	57	52			KBE-1000-60	KBE-1000-30	KBE-3010-20
H-BE 10 BS wire protection	10193000	screw	10	64	57	52			KBE-1000-60	KBE-1000-30	KBE-3010-20
H-BE 10 SS	10192100	screw	10	64	57	52			KBE-1000-60	KBE-1000-30	KBE-3010-20
H-BE 10 BS	10193100	screw	10	64	57	52			KBE-1000-60	KBE-1000-30	KBE-3010-20
H-BE 16 SS wire protection	10194000	screw	16	84,5	77,5	71			KBE-1000-60	KBE-1000-30	KBE-3016-20
H-BE 16 BS wire protection	10195000	screw	16	84,5	77,5	71			KBE-1000-60	KBE-1000-30	KBE-3016-20
H-BE 16 SS	10194100	screw	16	84,5	77,5	71			KBE-1000-60	KBE-1000-30	KBE-3016-20
H-BE 16 BS	10195100	screw	16	84,5	77,5	71			KBE-1000-60	KBE-1000-30	KBE-3016-20
H-BE 24 SS wire protection	10196000	screw	24	111	104	98			KBE-1000-60	KBE-1000-30	KBE-3024-20
H-BE 24 BS wire protection	10197000	screw	24	111	104	98			KBE-1000-60	KBE-1000-30	KBE-3024-20
H-BE 24 SS	10196100	screw	24	111	104	98			KBE-1000-60	KBE-1000-30	KBE-3024-20
H-BE 24 BS	10197100	screw	24	111	104	98			KBE-1000-60	KBE-1000-30	KBE-3024-20
H-BE 32 SS wire protection	10194000	screw	1-16	84,5	77,5	71			KBE-1000-60	KBE-1100-30	KBE-3032-20
H-BE 32 SS wire protection	10202000	screw	17-32	84,5	77,5	71			KBE-1000-60	KBE-1100-30	KBE-3032-20
H-BE 32 BS wire protection	10195000	screw	1-16	84,5	77,5	71			KBE-1000-60	KBE-1100-30	KBE-3032-20
H-BE 32 BS wire protection	10203000	screw	17-32	84,5	77,5	71			KBE-1000-60	KBE-1100-30	KBE-3032-20
H-BE 32 SS	10194100	screw	1-16	84,5	77,5	71			KBE-1000-60	KBE-1100-30	KBE-3032-20
H-BE 32 SS	10202100	screw	17-32	84,5	77,5	71			KBE-1000-60	KBE-1100-30	KBE-3032-20
H-BE 32 BS	10195100	screw	1-16	84,5	77,5	71			KBE-1000-60	KBE-1100-30	KBE-3032-20
H-BE 32 BS	10203100	screw	17-32	84,5	77,5	71			KBE-1000-60	KBE-1100-30	KBE-3032-20
H-BE 48 SS wire protection	10196000	screw	1-24	111	104	98			KBE-1000-60	KBE-1100-30	KBE-3048-20
H-BE 48 SS wire protection	10204000	screw	25-48	111	104	98			KBE-1000-60	KBE-1100-30	KBE-3048-20
H-BE 48 BS wire protection	10197000	screw	1-24	111	104	98			KBE-1000-60	KBE-1100-30	KBE-3048-20
H-BE 48 BS wire protection	10205000	screw	25-48	111	104	98			KBE-1000-60	KBE-1100-30	KBE-3048-20
H-BE 48 SS	10196100	screw	1-24	111	104	98			KBE-1000-60	KBE-1100-30	KBE-3048-20
H-BE 48 SS	10204100	screw	25-48	111	104	98			KBE-1000-60	KBE-1100-30	KBE-3048-20
H-BE 48 BS	10197100	screw	1-24	111	104	98			KBE-1000-60	KBE-1100-30	KBE-3048-20
H-BE 48 BS	10205100	screw	25-48	111	104	98			KBE-1000-60	KBE-1100-30	KBE-3048-20

A

C

L

Benennung	Art. Nr.	Version	Kontakte	L	L1	A	B	B1	Bild Nr.	Bild Nr.	Bild Nr.
Description	part No.	version	contacts	L	L1	A	B	B1	picture No.	picture No.	picture No.
Désignation	N° art.	version	contacts	L	L1	A	B	B1	page N°	page N°	page N°
H-BE 6 SCM	10180000	crimp	6	51	44	39	33	18	KBE-3000-60	KBE-1000-30	KBE-3006-20
H-BE 6 BCM	10181000	crimp	6	51	44	39	34	18	KBE-3000-60	KBE-1000-30	KBE-3006-20
H-BE 10 SCM	10182000	crimp	10	64	57	52	33	18	KBE-3000-60	KBE-1000-30	KBE-3010-20
H-BE 10 BCM	10183000	crimp	10	64	57	52	34	18	KBE-3000-60	KBE-1000-30	KBE-3010-20
H-BE 16 SCM	10184000	crimp	16	84,5	77,5	71	33	18	KBE-3000-60	KBE-1000-30	KBE-3016-20
H-BE 16 BCM	10185000	crimp	16	84,5	77,5	71	34	18	KBE-3000-60	KBE-1000-30	KBE-3016-20
H-BE 24 SCM	10186000	crimp	24	111	104	98	33	18	KBE-3000-60	KBE-1000-30	KBE-3024-20
H-BE 24 BCM	10187000	crimp	24	111	104	98	34	18	KBE-3000-60	KBE-1000-30	KBE-3024-20
H-BE 16 SCM	10184000	crimp	1-16	84,5	77,5	71	33	18	KBE-3000-60	KBE-1100-30	KBE-3032-20
H-BE 16 SCM	10184200	crimp	17-32	84,5	77,5	71	34	18	KBE-3000-60	KBE-1100-30	KBE-3032-20
H-BE 16 BCM	10185000	crimp	1-16	84,5	77,5	71	33	18	KBE-3000-60	KBE-1100-30	KBE-3032-20
H-BE 16 BCM	10185200	crimp	17-32	84,5	77,5	71	34	18	KBE-3000-60	KBE-1100-30	KBE-3032-20
H-BE 24 SCM	10186000	crimp	1-24	111	104	98	33	18	KBE-3000-60	KBE-1100-30	KBE-3048-20
H-BE 24 SCM	10186200	crimp	25-48	111	104	98	34	18	KBE-3000-60	KBE-1100-30	KBE-3048-20
H-BE 24 BCM	10187000	crimp	1-24	111	104	98	33	18	KBE-3000-60	KBE-1100-30	KBE-3048-20
H-BE 24 BCM	10187200	crimp	25-48	111	104	98	34	18	KBE-3000-60	KBE-1100-30	KBE-3048-20
H-BE 6 SF	10400000	Cage clamp	6	49,8	44	39			KBE-5000-60	KBE-1000-30	KBE-3006-20
H-BE 6 BF	10401000	Cage clamp	6	49,8	44	39			KBE-5000-60	KBE-1000-30	KBE-3006-20
H-BE 10 SF	10400100	Cage clamp	10	62,8	57	52			KBE-5000-60	KBE-1000-30	KBE-3010-20
H-BE 10 BF	10401100	Cage clamp	10	62,8	57	52			KBE-5000-60	KBE-1000-30	KBE-3010-20
H-BE 16 SF	10400200	Cage clamp	16	83,3	77,5	71			KBE-5000-60	KBE-1000-30	KBE-3016-20
H-BE 16 BF	10401200	Cage clamp	16	83,3	77,5	71			KBE-5000-60	KBE-1000-30	KBE-3016-20
H-BE 24 SF	10400300	Cage clamp	24	109,8	104	98			KBE-5000-60	KBE-1000-30	KBE-3024-20
H-BE 24 BF	10401300	Cage clamp	24	109,8	104	98			KBE-5000-60	KBE-1000-30	KBE-3024-20
H-BE 16 SF 1 - 16	10400200	Cage clamp	1-16	83,3	77,5	71			KBE-5000-60	KBE-1100-30	KBE-3032-20
H-BE 16 SF 17-32	10400400	Cage clamp	17-32	83,3	77,5	71			KBE-5000-60	KBE-1100-30	KBE-3032-20
H-BE 16 BF 1-16	10401200	Cage clamp	1-16	83,3	77,5	71			KBE-5000-60	KBE-1100-30	KBE-3032-20
H-BE 16 BF 17-32	10401400	Cage clamp	17-32	83,3	77,5	71			KBE-5000-60	KBE-1100-30	KBE-3032-20
H-BE 24 SF 1-16	10400300	Cage clamp	1-24	109,8	104	98			KBE-5000-60	KBE-1100-30	KBE-3048-20
H-BE 24 SF 25-48	10400500	Cage clamp	25-48	109,8	104	98			KBE-5000-60	KBE-1100-30	KBE-3048-20
H-BE 24 BF 1-16	10401300	Cage clamp	1-24	109,8	104	98			KBE-5000-60	KBE-1100-30	KBE-3048-20
H-BE 24 BF 25-48	10401500	Cage clamp	25-48	109,8	104	98			KBE-5000-60	KBE-1100-30	KBE-3048-20

A

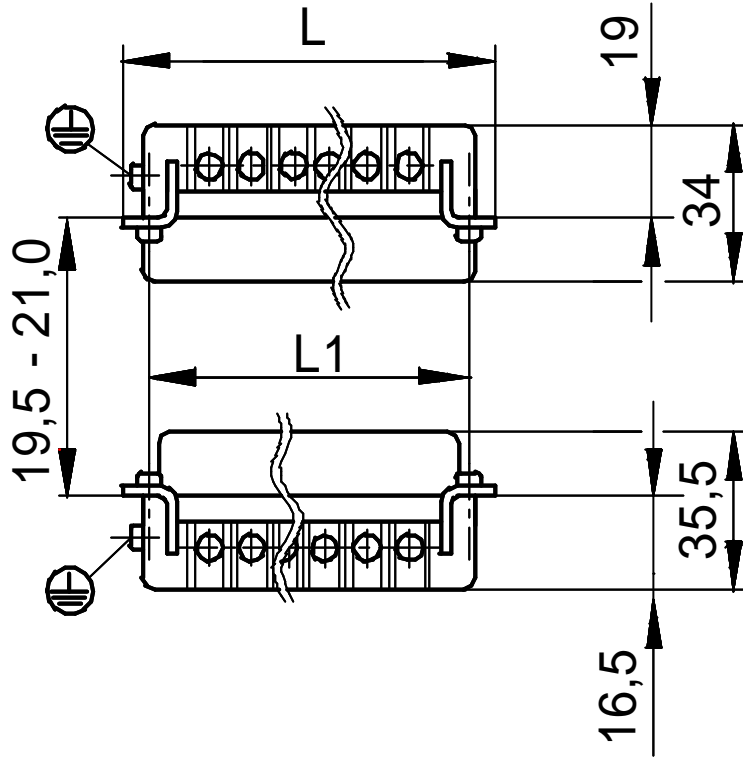

KBE-1000-65

C

L

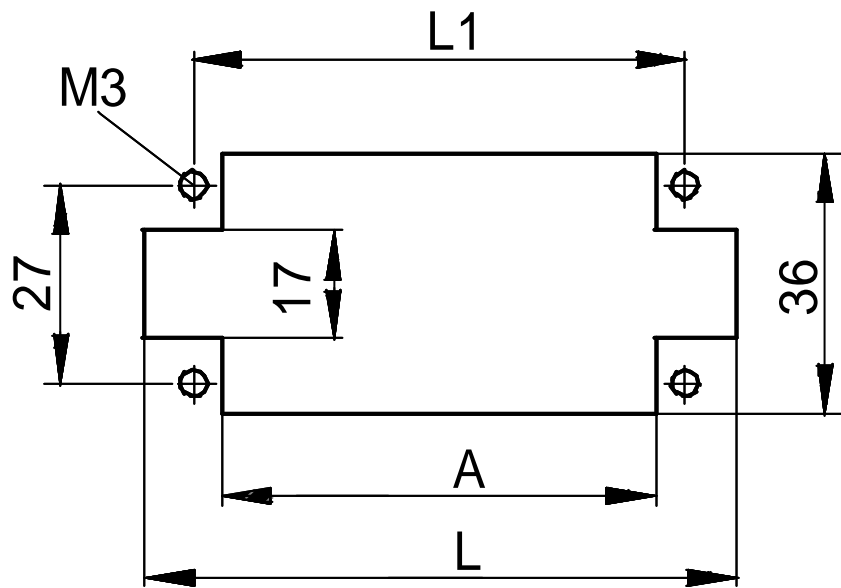
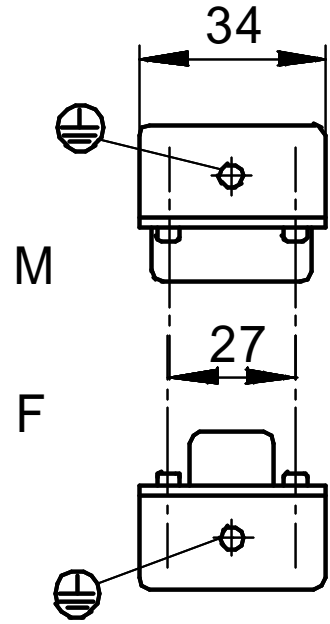

KBE-1000-30

A

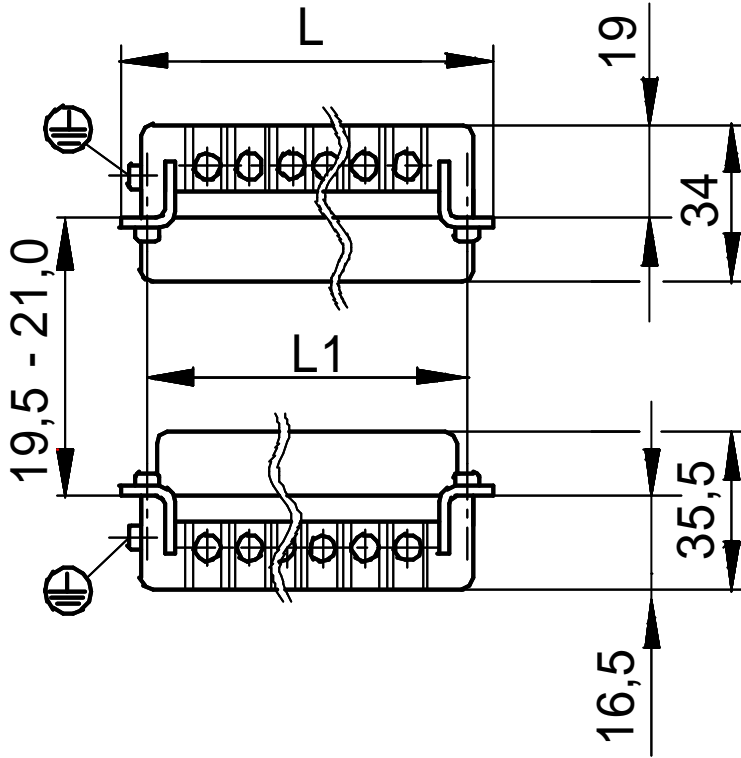

KBE-1000-65

C

L

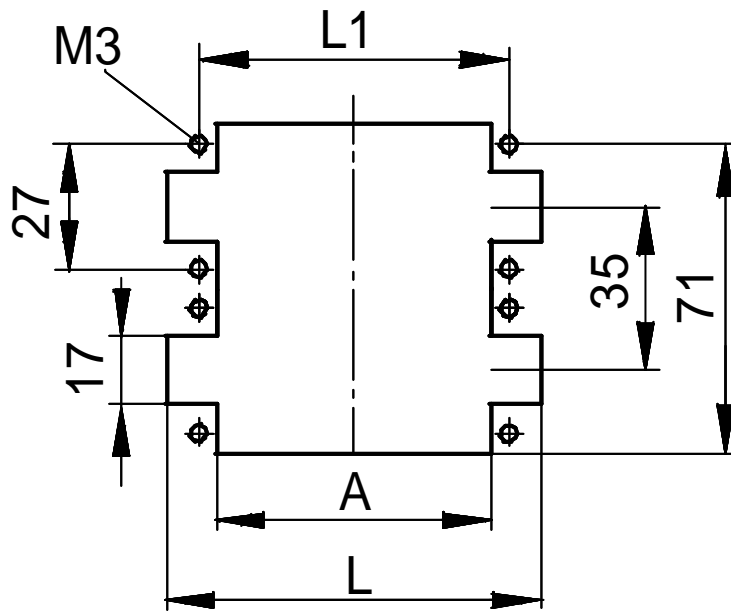
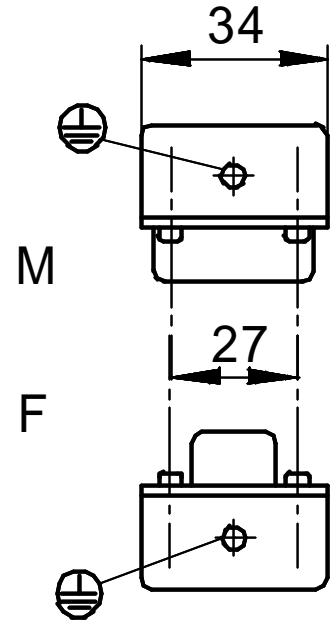

KBE-1100-30

A

C

L

view from cable side

M

F

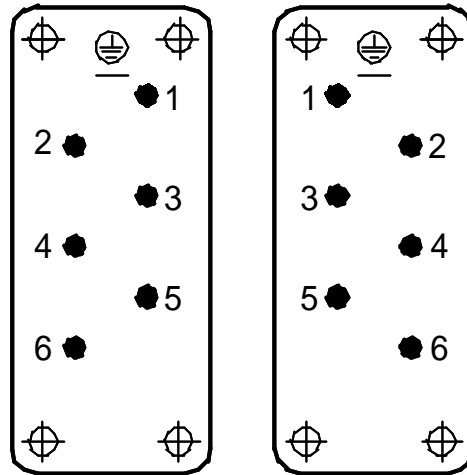

KBE-3006-25

view from cable side

M

F

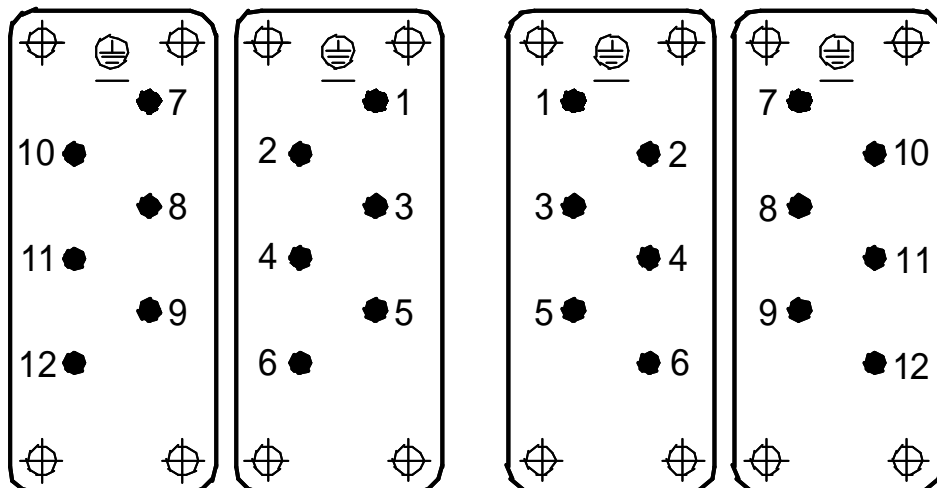

KBE-3012-25

A

C

L

Benennung	Art. Nr.	Version	Kontakte				Bild Nr.	Bild Nr.	Bild Nr.
Description	part No.	version	contacts	L	L1	A	picture No.	picture No.	picture No.
Désignation	N° art.	version	contacts				page N°	page N°	page N°
H-BS 6 S wire protection	10170000	screw	6	84,5	77,5	71	KBE-1000-65	KBE-3006-25	KBE-1000-30
H-BS 6 B wire protection	10171000	screw	6	84,5	77,5	71	KBE-1000-65	KBE-3006-25	KBE-1000-30
H-BS 12 S wire protection	10170000	screw	1-6	84,5	77,5	71	KBE-1000-65	KBE-3012-25	KBE-1100-30
H-BS 12 S wire protection	10170600	screw	7-12	84,5	77,5	71	KBE-1000-65	KBE-3012-25	KBE-1100-30
H-BS 12 B wire protection	10171000	screw	1-6	84,5	77,5	71	KBE-1000-65	KBE-3012-25	KBE-1100-30
H-BS 12 B wire protection	10171600	screw	7-12	84,5	77,5	71	KBE-1000-65	KBE-3012-25	KBE-1100-30

A

C

L

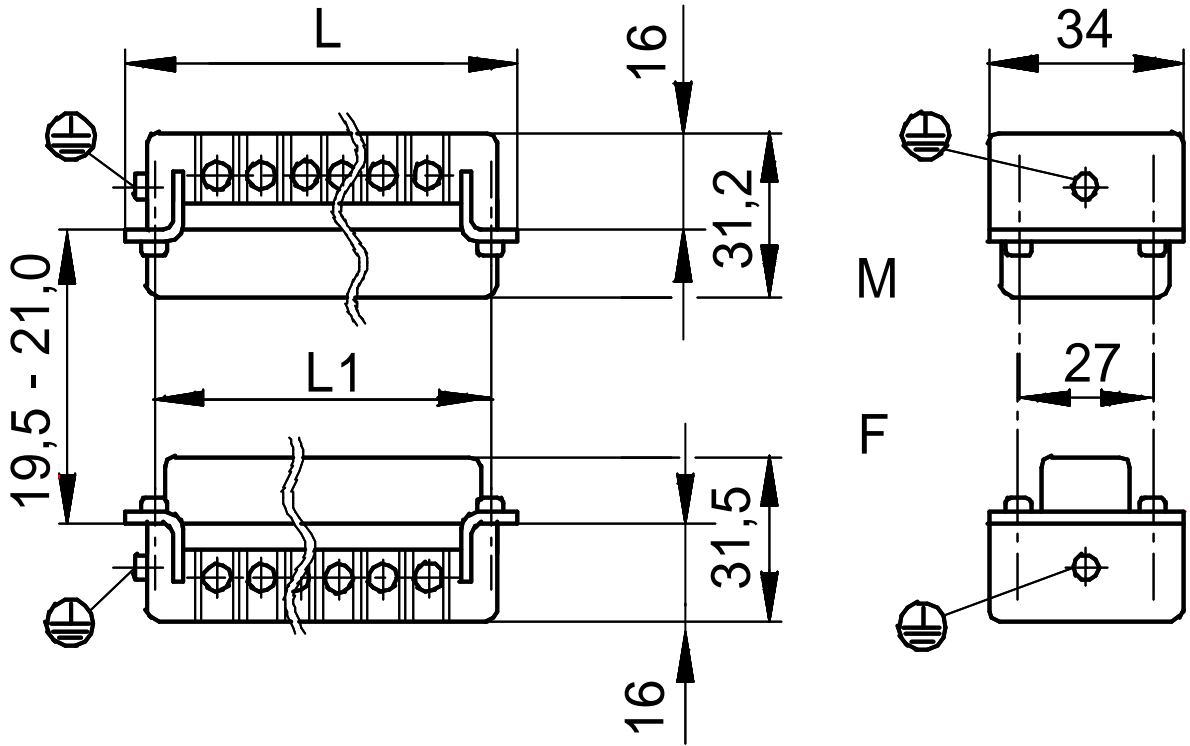

KBE-1000-60

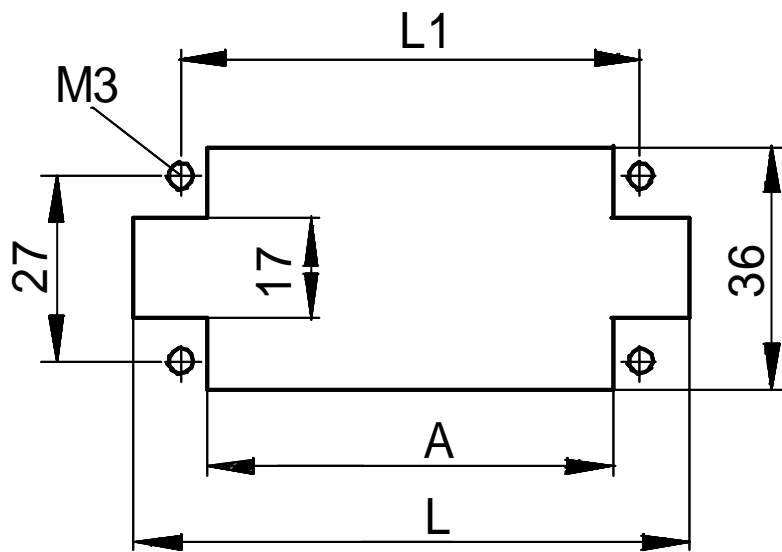

KBE-1000-30

A

view from cable side

M

F

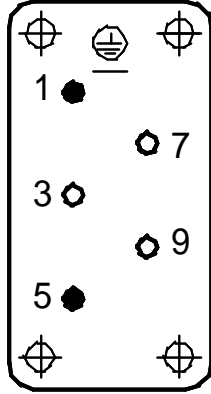
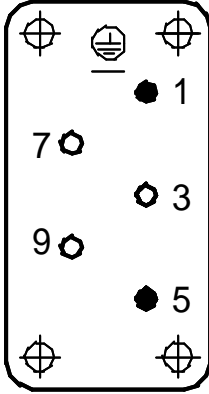

●
Schaltkontakt
mating contact
contact de branchement

○
Arbeitskontakt
working contact
contact de travail

C

L

view from cable side

KBE-1003-20

M

F

M

F

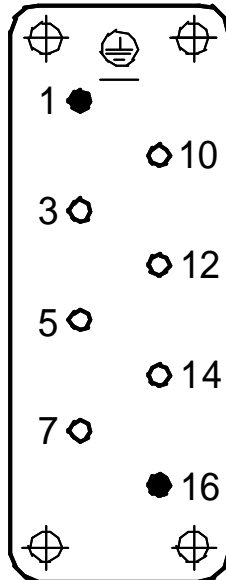
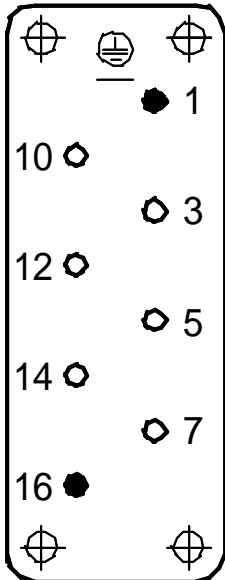

KBE-1006-20

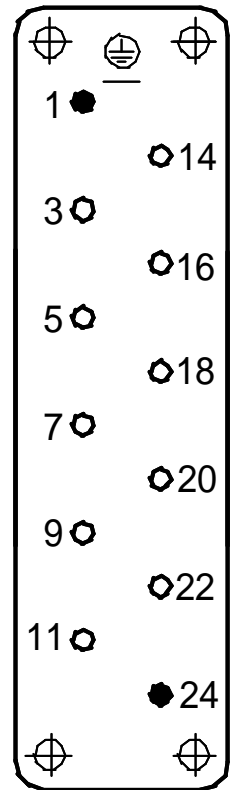
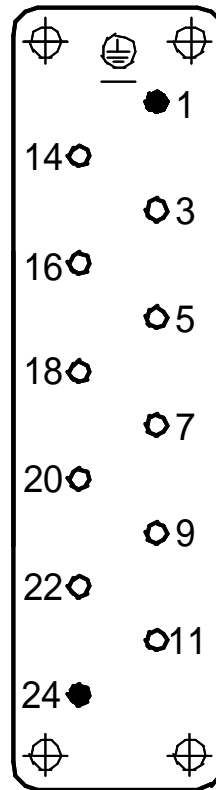

KBE-1010-20

A

C

L

Benennung Description Désignation	Art. Nr. part No. N° art.	Version version version	Kontakte contacts contacts	L	L1	A	Bild Nr. picture No. page N°	Bild Nr. picture No. page N°	Bild Nr. picture No. page N°
H-BVE 3 SS wire protection	10210010	male	3	64	57	52	KBE-1000-60	KBE-1003-20	KBE-1000-30
H-BVE 3 BS wire protection	10211010	female	3	64	57	52	KBE-1000-60	KBE-1003-20	KBE-1000-30
H-BVE 3 SS	10210110	male	3	64	57	52	KBE-1000-60	KBE-1003-20	KBE-1000-30
H-BVE 3 BS	10211110	female	3	64	57	52	KBE-1000-60	KBE-1003-20	KBE-1000-30
H-BVE 6 SS wire protection	10239010	male	6	84,5	77,5	71	KBE-1000-60	KBE-1006-20	KBE-1000-30
H-BVE 6 BS wire protection	10240010	female	6	84,5	77,5	71	KBE-1000-60	KBE-1006-20	KBE-1000-30
H-BVE 6 SS	10239110	male	6	84,5	77,5	71	KBE-1000-60	KBE-1006-20	KBE-1000-30
H-BVE 6 BS	10240110	female	6	84,5	77,5	71	KBE-1000-60	KBE-1006-20	KBE-1000-30
H-BVE 10 SS wire protection	10270010	male	10	111	104	98	KBE-1000-60	KBE-1010-20	KBE-1000-30
H-BVE 10 BS wire protection	10271010	female	10	111	104	98	KBE-1000-60	KBE-1010-20	KBE-1000-30
H-BVE 10 SS	10270110	male	10	111	104	98	KBE-1000-60	KBE-1010-20	KBE-1000-30
H-BVE 10 BS	10271110	female	10	111	104	98	KBE-1000-60	KBE-1010-20	KBE-1000-30

A

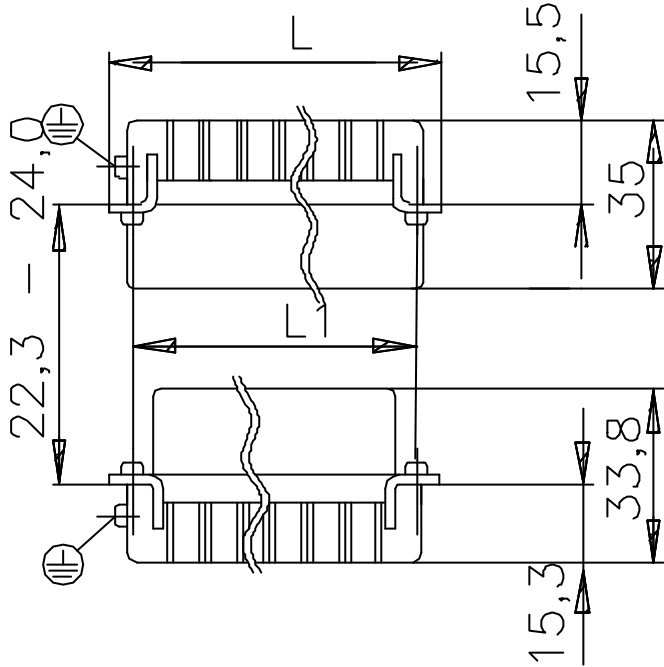

C

L

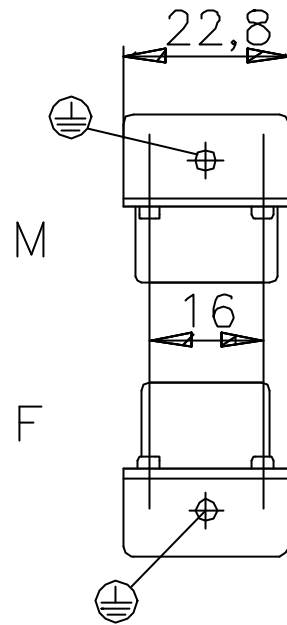

KDE-3100-60

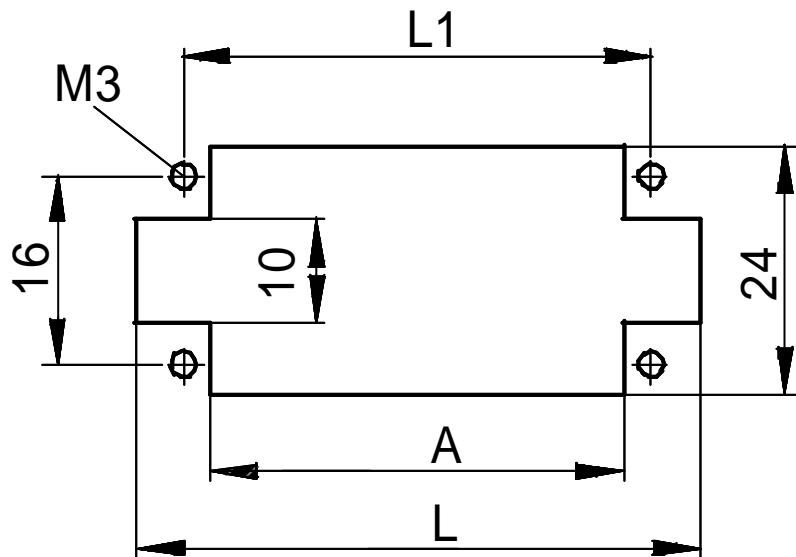

KAE-1000-30

A

C

L

view from cable side

M

F

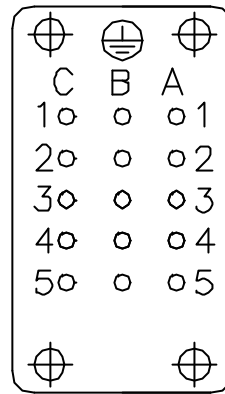
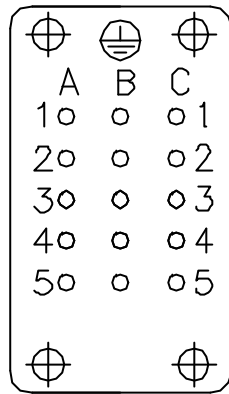

KDE-3015-20

view from cable side

M

F

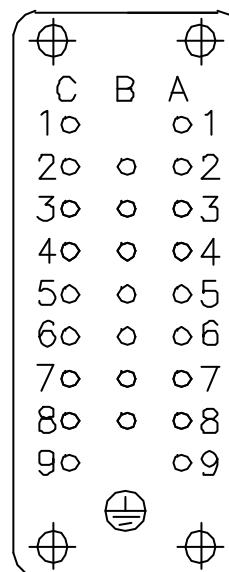
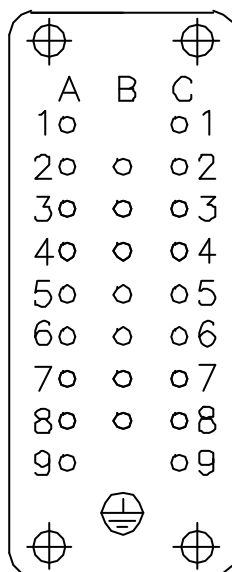

KDE-3025-20

A

C

L

view from cable side

M

F

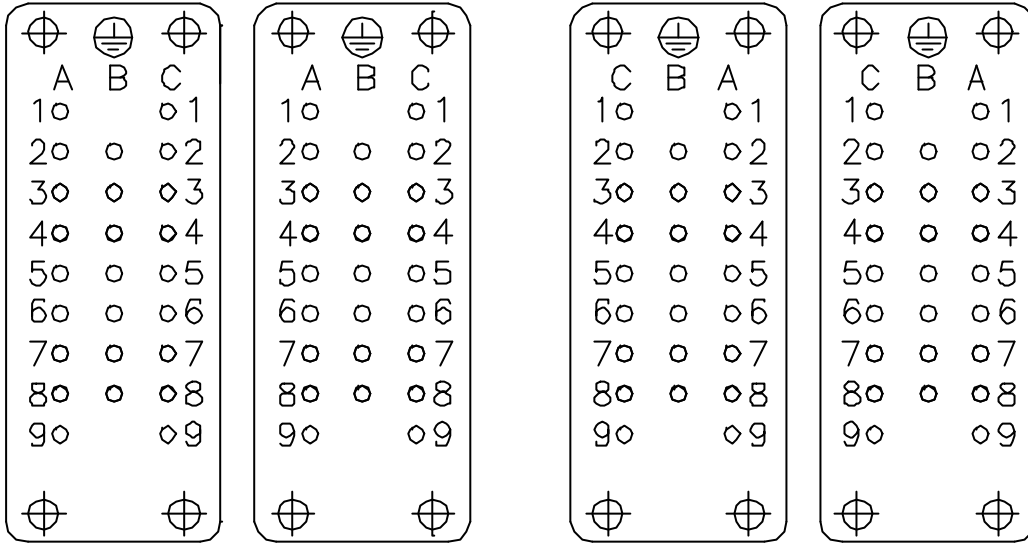

KDE-3050-20

A

C

L

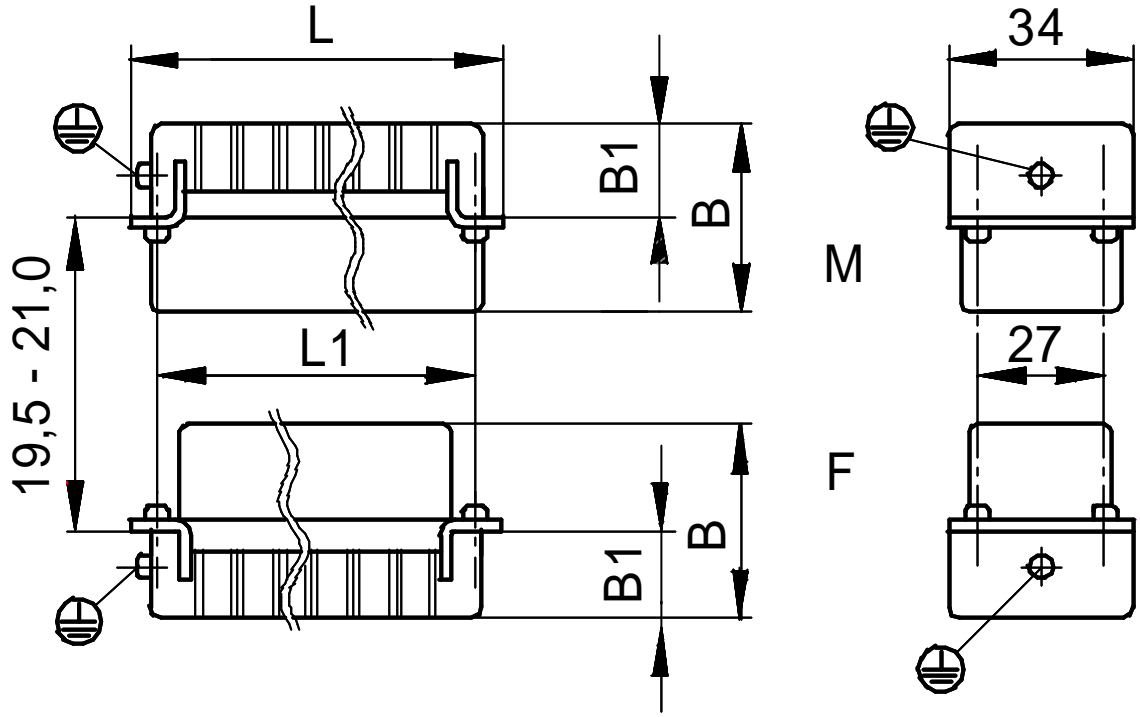

KBE-3000-60

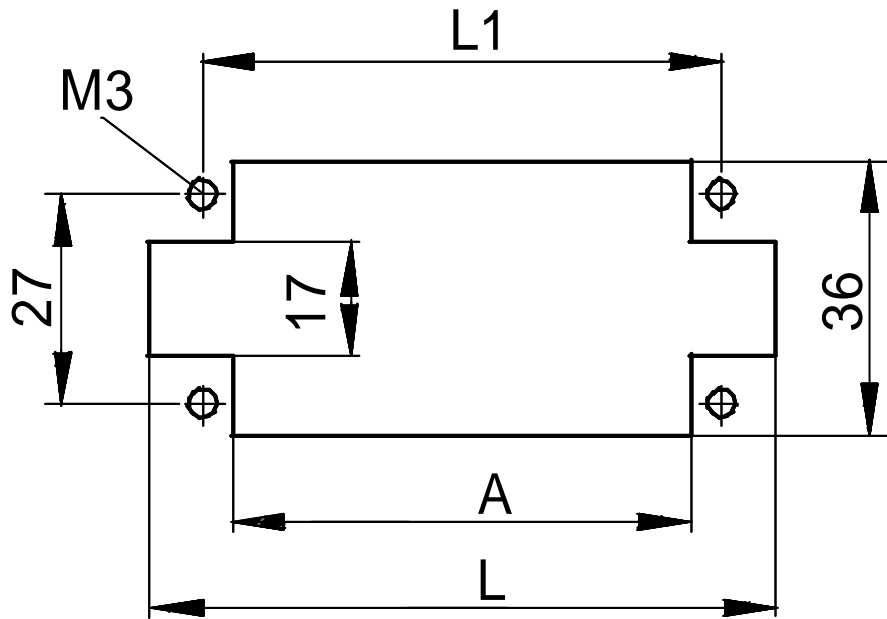

KBE-1000-30

A

C

L

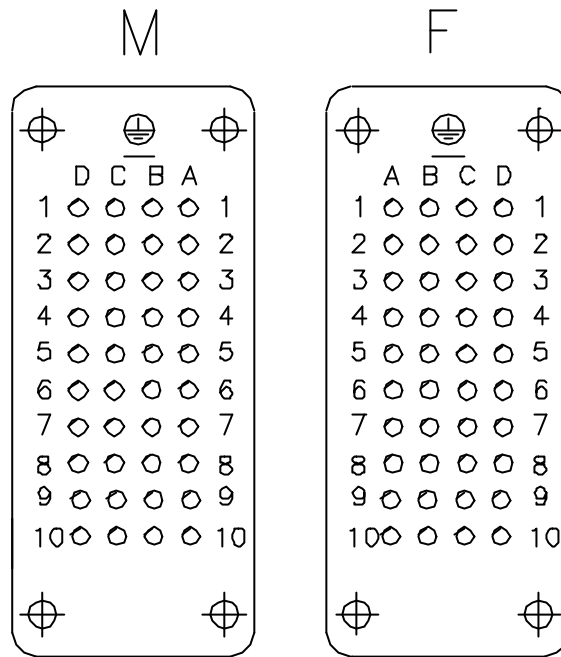

view from cable side

KDE-3040-20

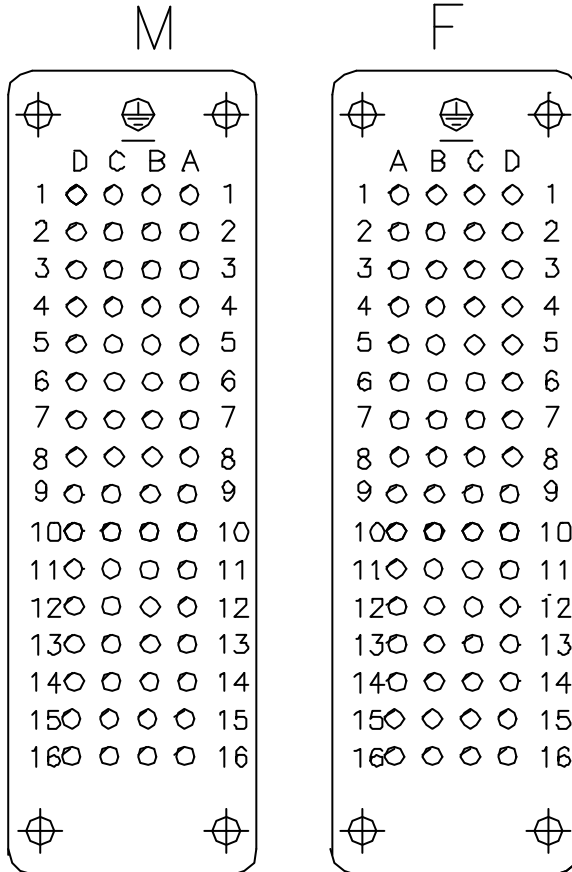

KDE-3064-20

A

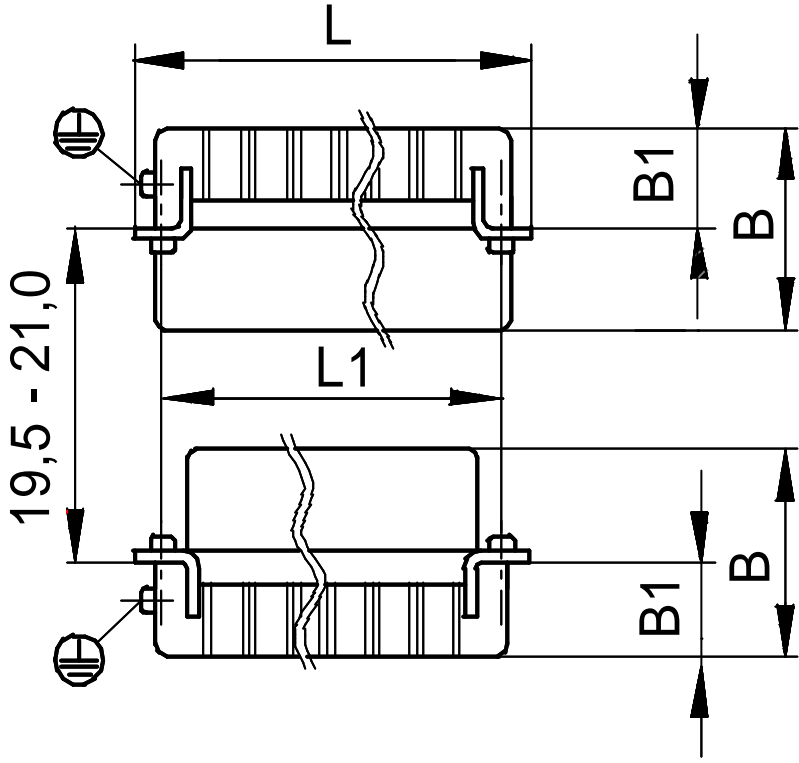

C

L

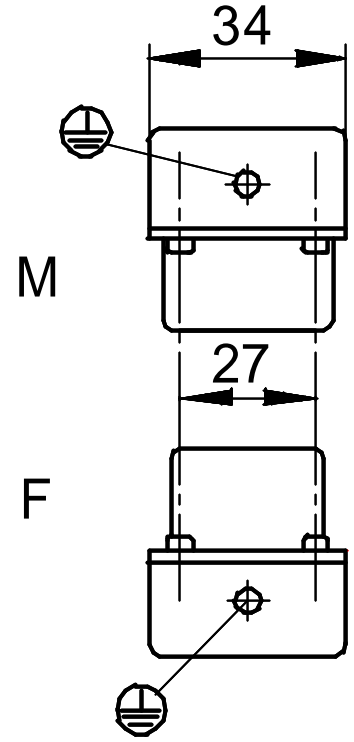

KBE-3000-60

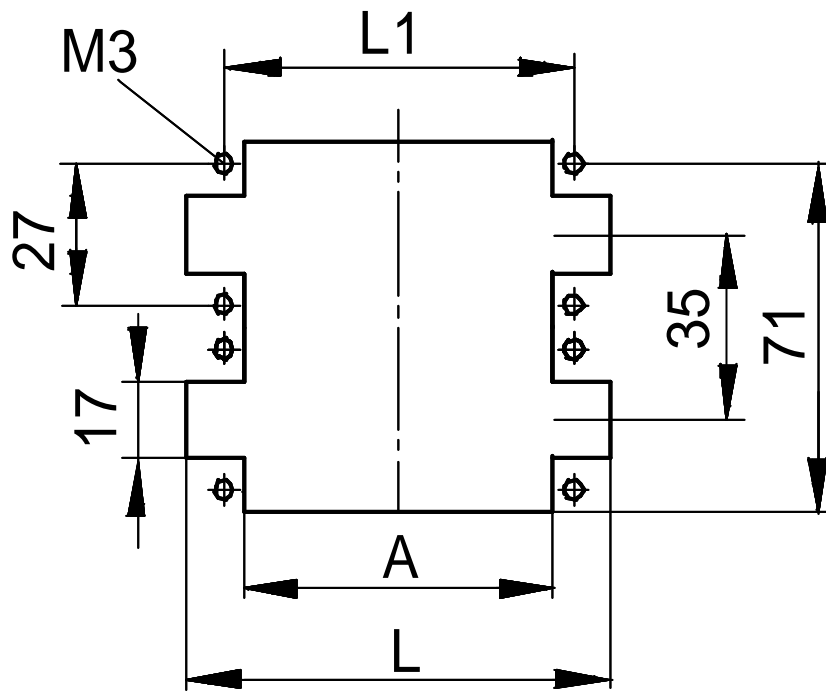

KBE-1100-30

A

C

L

view from cable side

M

F

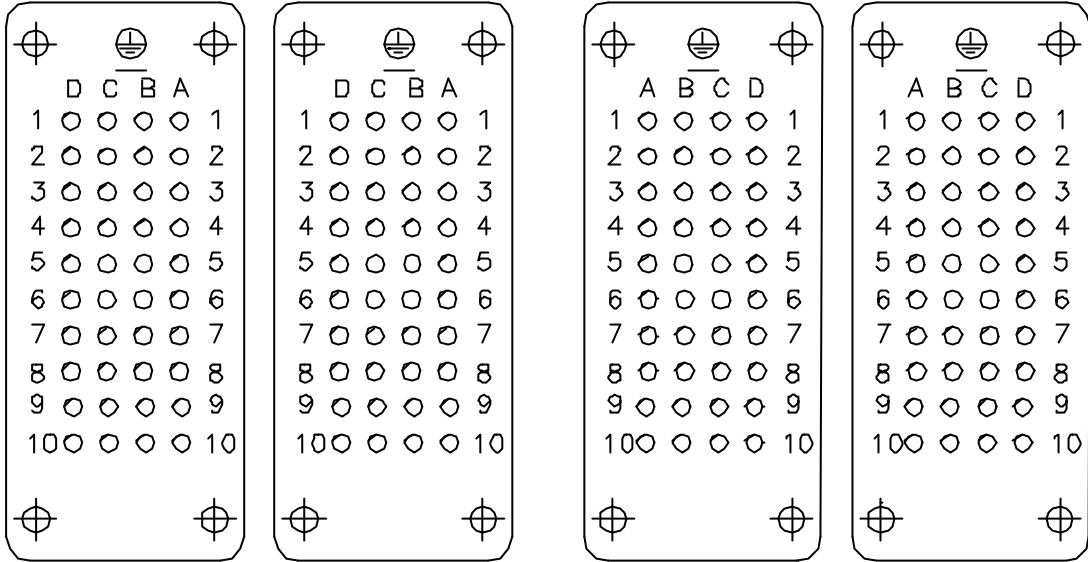

KDE-3080-20

M

F

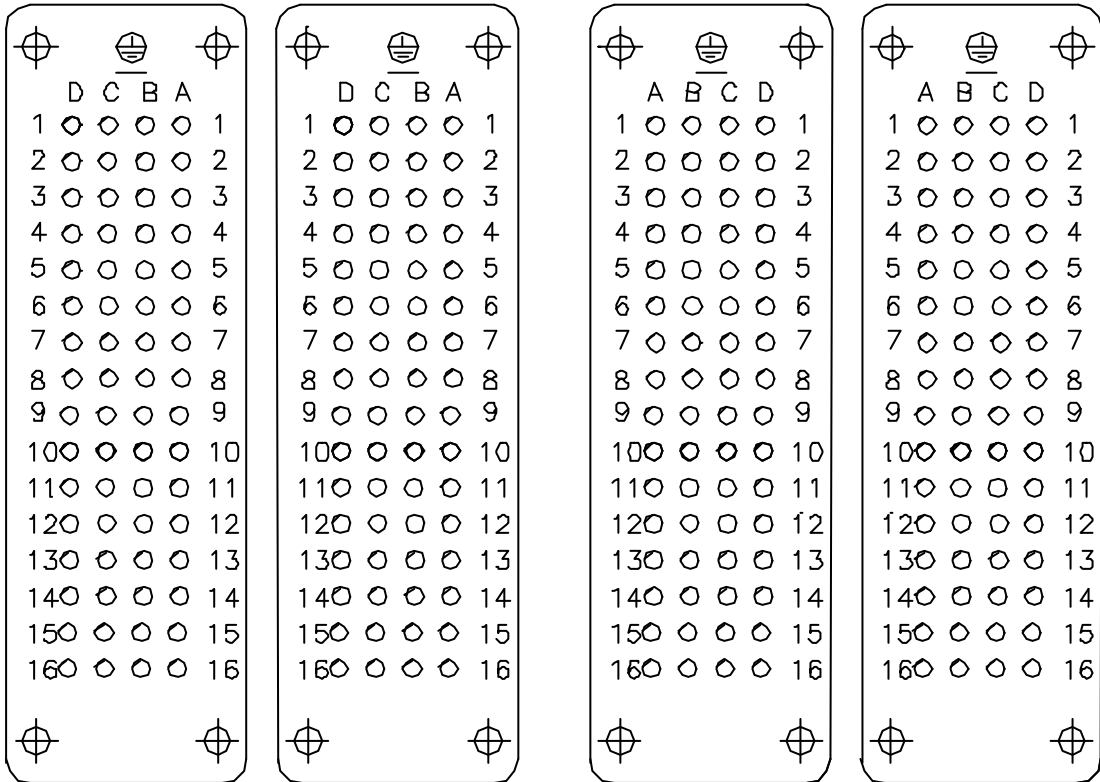

KDE-3128-20

A

C

L

Benennung Description Désignation	Art. Nr. part No. N° art.	Version version version	Kontakte contacts contacts	L	L1	A / H	B	B1	Bild Nr. picture No. page N°	Bild Nr. picture No. page N°	Bild Nr. picture No. page N°
H-D 7 SCM	11250500	male	7	21	23,6	34			KDE-3000-60	KDE-3007-20	
H-D 7 BCM	11251500	female	7	21	17	33,2			KDE-3000-60	KDE-3007-20	
H-D 7 SCG	11250000	male	7	21	23,6	33,6			KDE-3000-60	KDE-3007-20	
H-D 7 BCG	11251000	female	7	21	17	32,2			KDE-3000-60	KDE-3007-20	
H-D 8 SCM	11252500	male	8	21	23,6	34			KDE-3000-60	KDE-3008-20	
H-D 8 BCM	11253500	female	8	21	17	33,2			KDE-3000-60	KDE-3008-20	
H-D 15 SCM	11255100	male	15	56,5	49,5	42,5			KDE-3100-60	KAE-1000-30	KDE-3015-20
H-D 15 BCM	11256100	female	15	56,5	49,5	42,5			KDE-3100-60	KAE-1000-30	KDE-3015-20
H-D 15 SCG	11255000	male	15	56,5	49,5	42,5			KDE-3100-60	KAE-1000-30	KDE-3015-20
H-D 15 BCG	11256000	female	15	56,5	49,5	42,5			KDE-3100-60	KAE-1000-30	KDE-3015-20
H-D 25 SCM	11260200	male	25	73	66	60			KDE-3100-60	KAE-1000-30	KDE-3025-20
H-D 25 BCM	11261200	female	25	73	66	60			KDE-3100-60	KAE-1000-30	KDE-3025-20
H-D 25 SCG	11260000	male	25	73	66	60			KDE-3100-60	KAE-1000-30	KDE-3025-20
H-D 25 BCG	11261000	female	25	73	66	60			KDE-3100-60	KAE-1000-30	KDE-3025-20
H-D 50 SCM	11260200	male	2 x 25	73	66	60			KDE-3100-60	KAE-1100-30	KDE-3050-20
H-D 50 BCM	11261200	female	2 x 25	73	66	60			KDE-3100-60	KAE-1100-30	KDE-3050-20
H-D 50 SCG	11260000	male	2 x 25	73	66	60			KDE-3100-60	KAE-1100-30	KDE-3050-20
H-D 50 BCG	11261000	female	2 x 25	73	66	60			KDE-3100-60	KAE-1100-30	KDE-3050-20
H-D 40 SCM	11265200	male	40	84,5	77,5	71	39,3	24	KBE-3000-60	KBE-1000-30	KDE-3040-20
H-D 40 BCM	11266200	female	40	84,5	77,5	71	34,6	16	KBE-3000-60	KBE-1000-30	KDE-3040-20
H-D 40 SCG	11265000	male	40	84,5	77,5	71	34	19	KBE-3000-60	KBE-1000-30	KDE-3040-20
H-D 40 BCG	11266000	female	40	84,5	77,5	71	36	18	KBE-3000-60	KBE-1000-30	KDE-3040-20
H-D 64 SCM	11272000	male	64	111	104	98	39,3	24	KBE-3000-60	KBE-1000-30	KDE-3064-20
H-D 64 BCM	11273000	female	64	111	104	98	34,6	16	KBE-3000-60	KBE-1000-30	KDE-3064-20
H-D 64 SCG	11270000	male	64	111	104	98	34	19	KBE-3000-60	KBE-1000-30	KDE-3064-20
H-D 64 BCG	11271000	female	64	111	104	98	36	18	KBE-3000-60	KBE-1000-30	KDE-3064-20

A

C

L

Benennung	Art. Nr.	Version	Kontakte						Bild Nr.	Bild Nr.	Bild Nr.
Description	part No.	version	contacts	L	L1	A / H	B	B1	picture No.	picture No.	picture No.
Désignation	N° art.	version	contacts						page N°	page N°	page N°
H-D 80 SCM	11265200	male	2 x 40=80	84,5	77,5	71	39,3	24	KBE-3000-60	KBE-1100-30	KDE-3080-20
H-D 80 BCM	11266200	female	2 x 40=80	84,5	77,5	71	34,6	16	KBE-3000-60	KBE-1100-30	KDE-3080-20
H-D 80 SCG	11265000	male	2 x 40=80	84,5	77,5	71	34	19	KBE-3000-60	KBE-1100-30	KDE-3080-20
H-D 80 BCG	11266000	female	2 x 40=80	84,5	77,5	71	36	18	KBE-3000-60	KBE-1100-30	KDE-3080-20
H-D 128 SCM	11272000	male	2 x 64=128	111	104	98	39,3	24	KBE-3000-60	KBE-1100-30	KDE-3128-20
H-D 128 BCM	11273000	female	2 x 64=128	111	104	98	34,6	16	KBE-3000-60	KBE-1100-30	KDE-3128-20
H-D 128 SCG	11270000	male	2 x 64=128	111	104	98	34	19	KBE-3000-60	KBE-1100-30	KDE-3128-20
H-D 128 BCG	11271000	female	2 x 64=128	111	104	98	36	18	KBE-3000-60	KBE-1100-30	KDE-3128-20

A

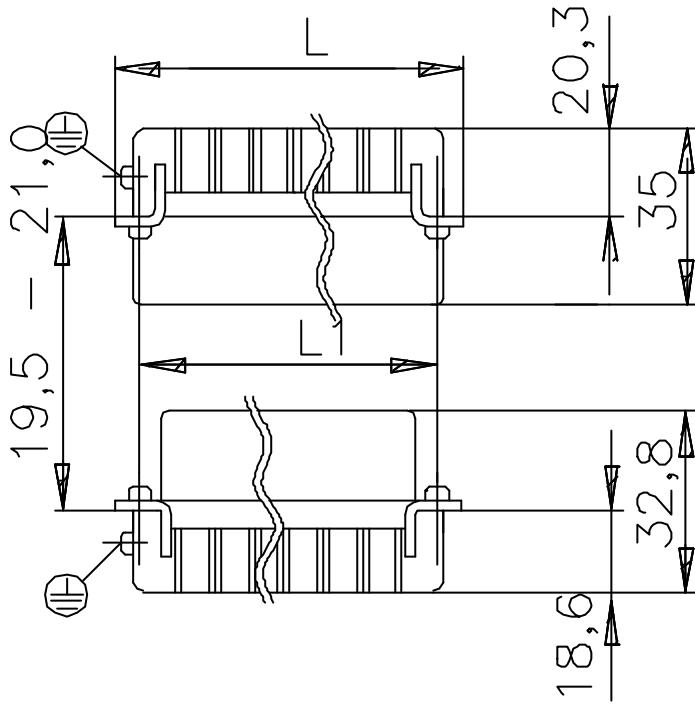

C

L

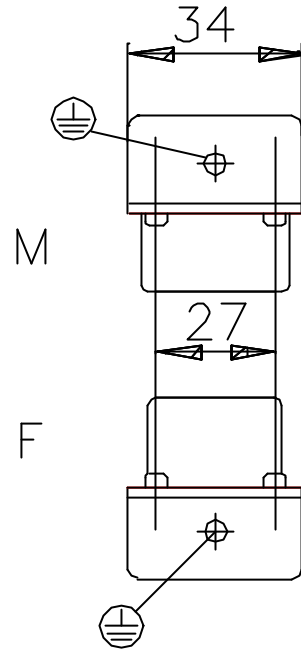

KDE-3000-65

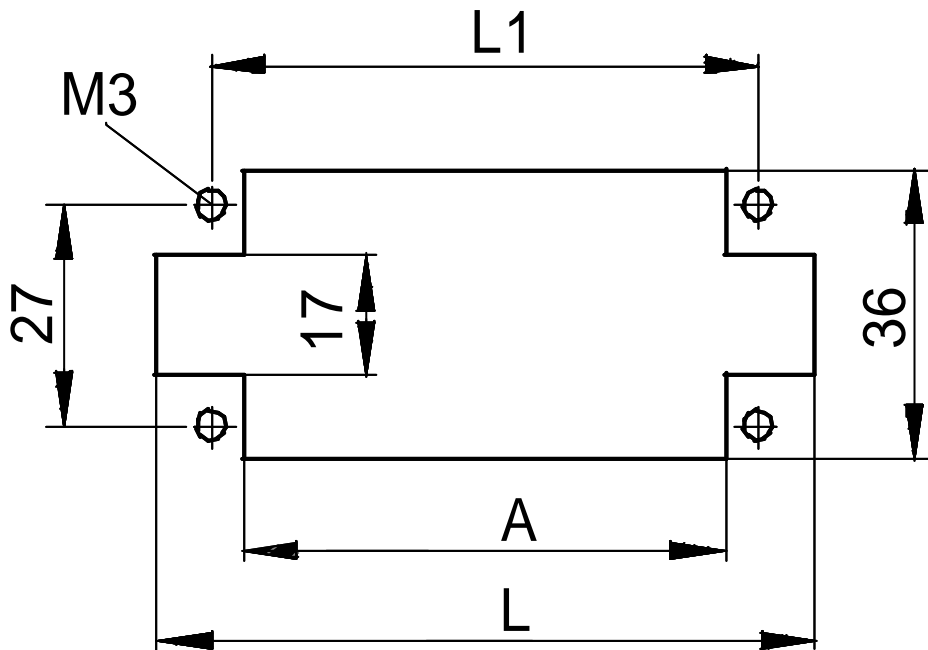

KBE-1000-30

EPIC® H-DD inserts

A

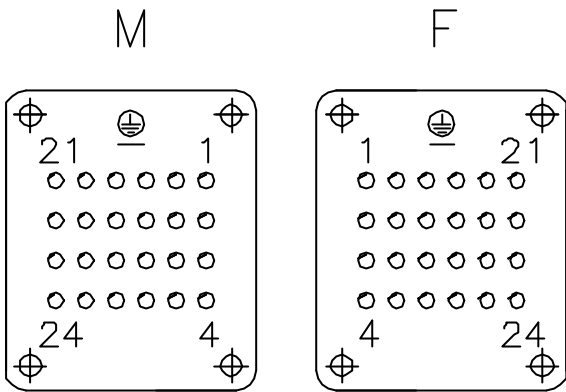

KDE-3024-25

C

L

view from cable side

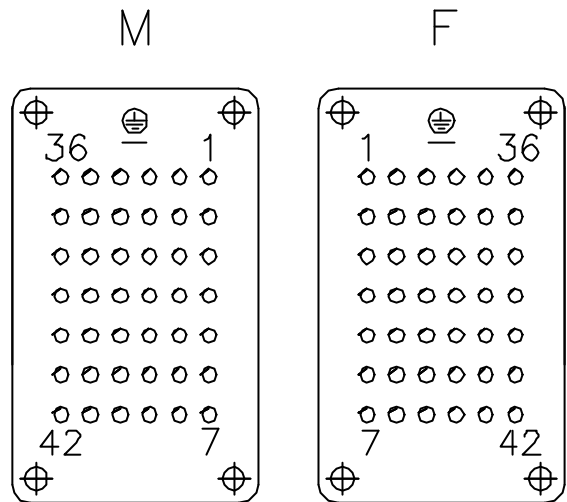

KDE-3042-25

view from cable side

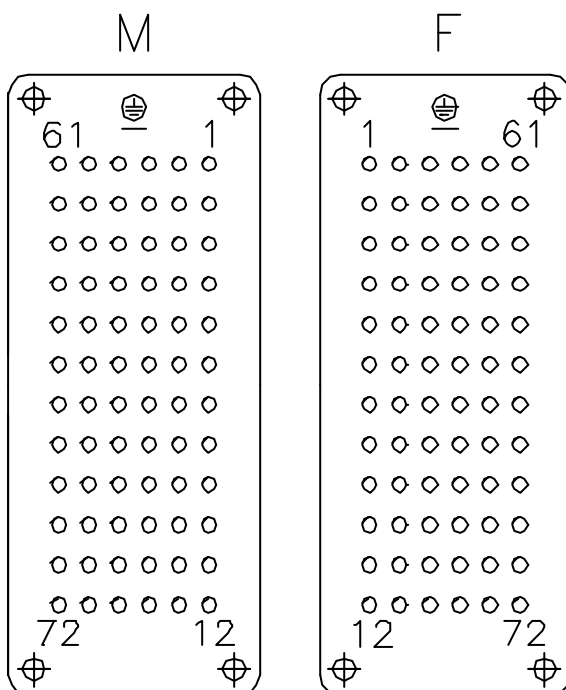

KDE-3072-25

A

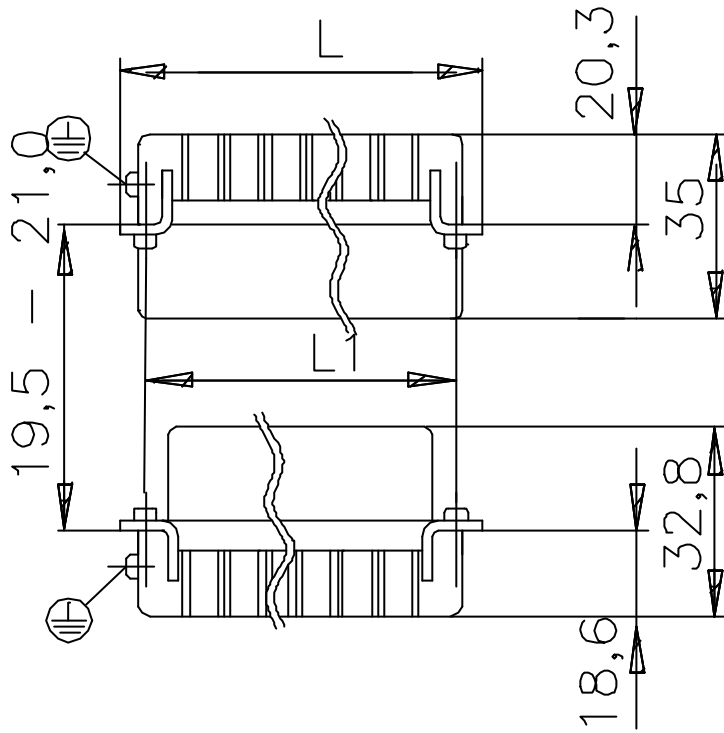

C

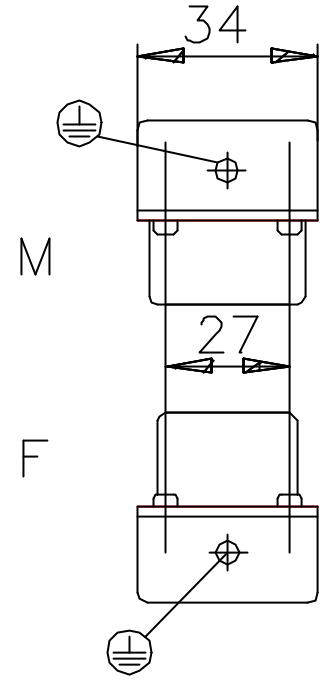

L

KDE-3000-65

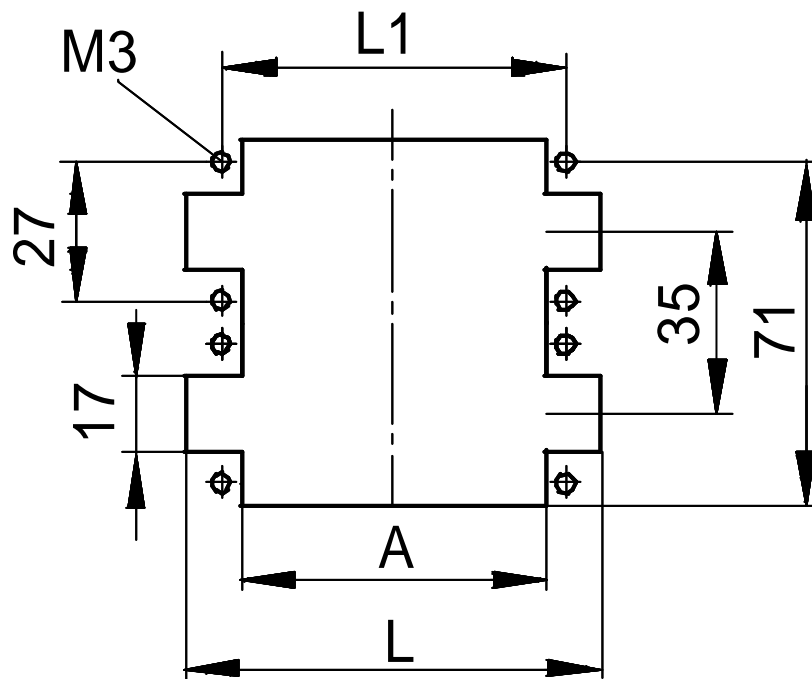

KBE-1100-30

EPIC® H-DD inserts

A

view from cable side

C

L

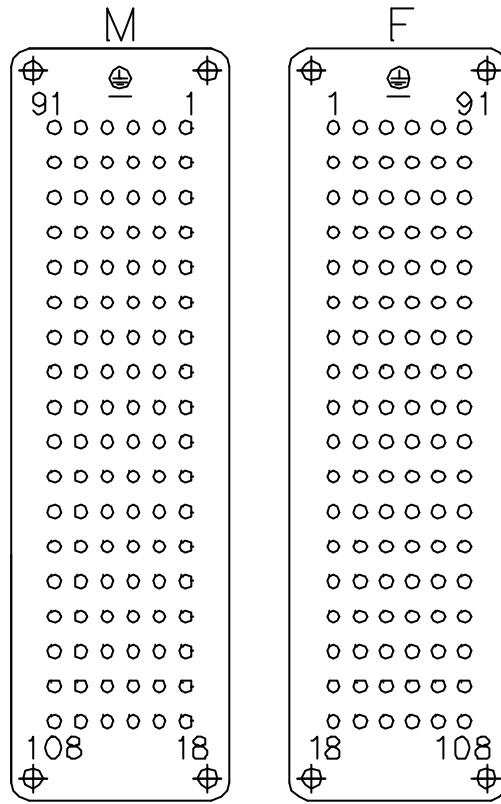

view from cable side

KDE-3108-25

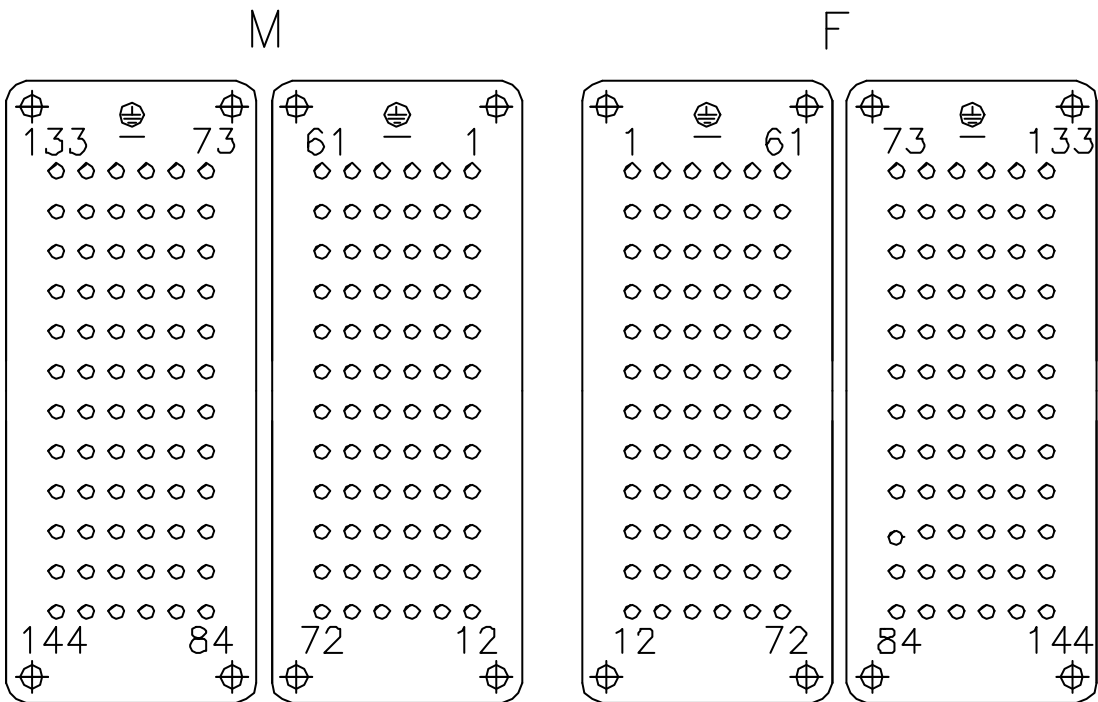

KDE-3144-25

A

C

L

view from cable side

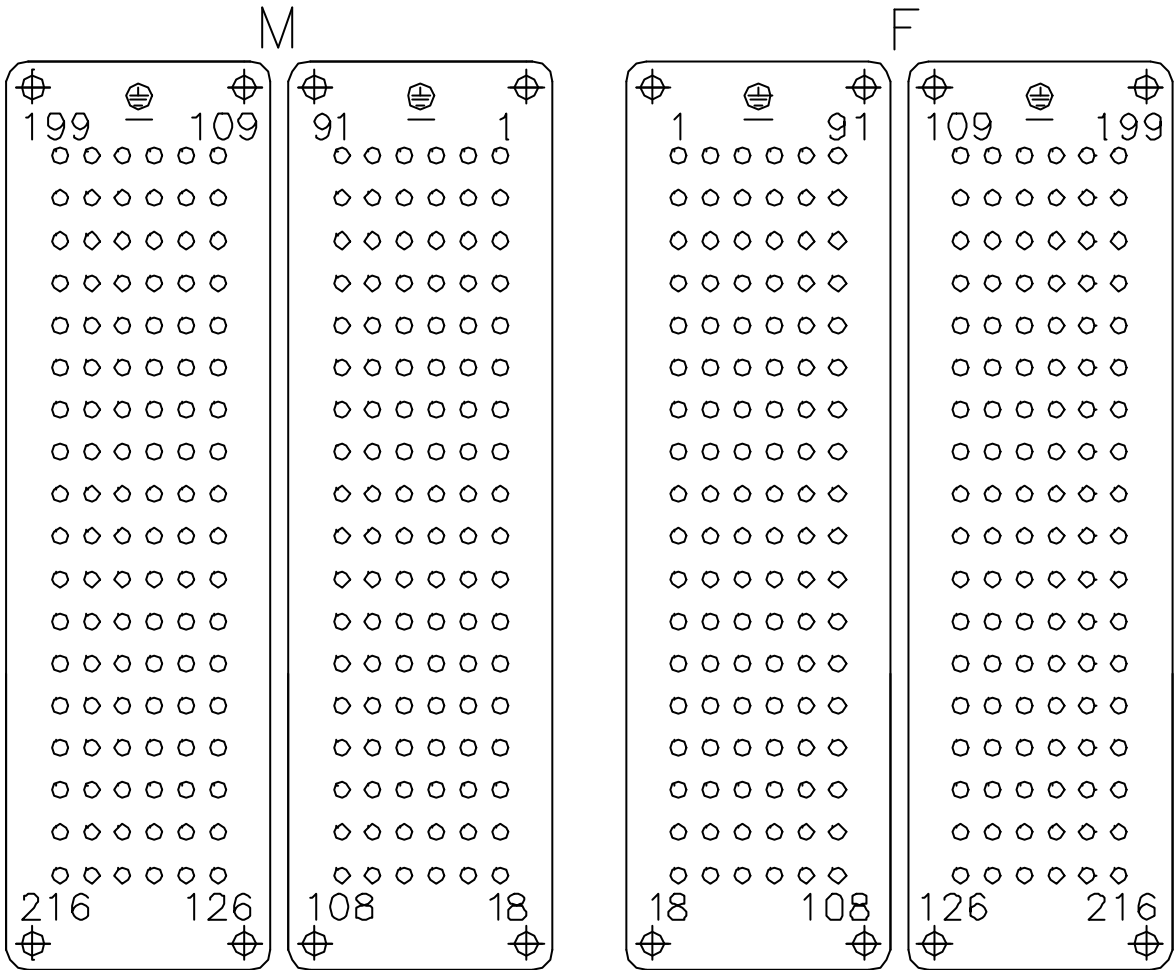

KDE-3216-25

A

C

L

Benennung	Art. Nr.	Version	Kontakte				Bild Nr.	Bild Nr.	Bild Nr.
Description	part No.	version	contacts	L	L1	A	picture No.	picture No.	picture No.
Désignation	N° art.	version	contacts				page N°	page N°	page N°
H-DD 24 SCM	11285000	male	24	50,5	44	36	KDE-3000-65	KDE-3024-25	KBE-1000-30
H-DD 24 BCM	11286000	female	24	50,5	44	36	KDE-3000-65	KDE-3024-25	KBE-1000-30
H-DD 42 SCM	11285100	male	42	63,5	57	49	KDE-3000-65	KDE-3042-25	KBE-1000-30
H-DD 42 BCM	11286100	female	42	63,5	57	49	KDE-3000-65	KDE-3042-25	KBE-1000-30
H-DD 72 SCM	11285200	male	72	84	77,5	69,5	KDE-3000-65	KDE-3072-25	KBE-1000-30
H-DD 72 BCM	11286200	female	72	84	77,5	69,5	KDE-3000-65	KDE-3072-25	KBE-1000-30
H-DD 108 SCM 1-108	11285300	male	108	110,5	104	96	KDE-3000-65	KDE-3108-25	KBE-1000-30
H-DD 108 BCM 1-108	11286300	female	108	110,5	104	96	KDE-3000-65	KDE-3108-25	KBE-1000-30
H-DD 72 SCM 1-72	11285200	male	1 - 72	84	77,5	69,5	KDE-3000-65	KDE-3144-25	KBE-1100-30
H-DD 72 SCM 73-144	11285400	male	73 - 144	84	77,5	69,5	KDE-3000-65	KDE-3144-25	KBE-1100-30
H-DD 72 BCM 1-72	11286200	female	1 - 72	84	77,5	69,5	KDE-3000-65	KDE-3144-25	KBE-1100-30
H-DD 72 BCM 73-144	11286400	female	73 - 144	84	77,5	69,5	KDE-3000-65	KDE-3144-25	KBE-1100-30
H-DD 108 SCM 1-108	11285300	male	1 - 108	110,5	104	96	KDE-3000-65	KDE-3216-25	KBE-1100-30
H-DD 108 SCM 109-216	11285500	male	109 - 216	110,5	104	96	KDE-3000-65	KDE-3216-25	KBE-1100-30
H-DD 108 BCM 1-108	11286300	female	1 - 108	110,5	104	96	KDE-3000-65	KDE-3216-25	KBE-1100-30
H-DD 108 BCM 109-216	11286500	female	109 - 216	110,5	104	96	KDE-3000-65	KDE-3216-25	KBE-1100-30

A

C

L

view from cable side

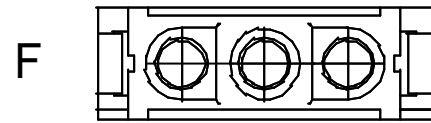
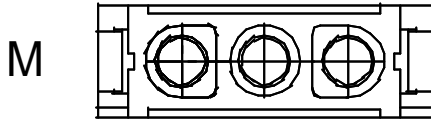

KBE-4003-21

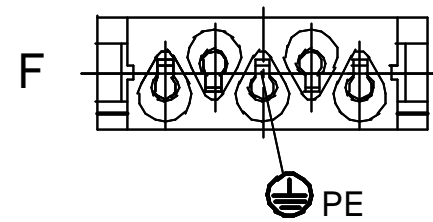
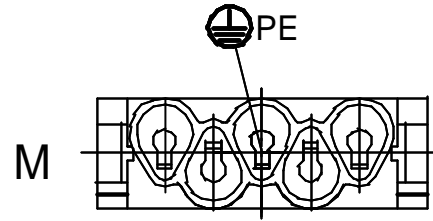

KBE-4005-25

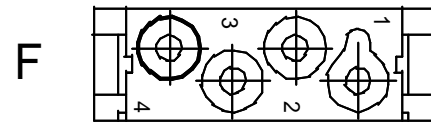
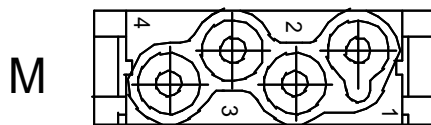

KBE-4004-20

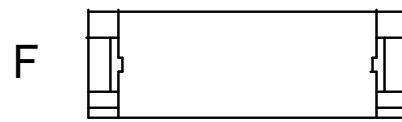
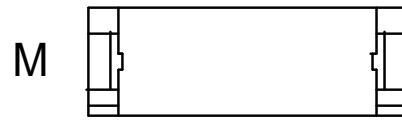

KBE-4000-20

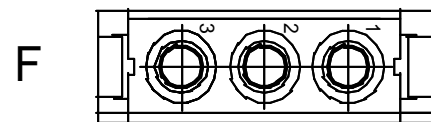
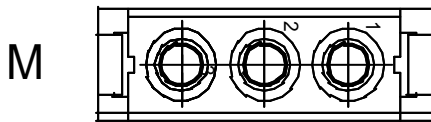

KBE-4003-20

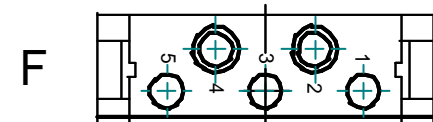
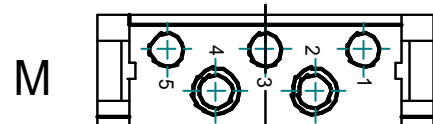

KBE-4005-20

view from cable side

A

C

L

view from cable side

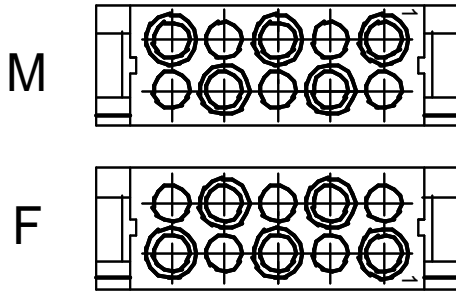

KBE-4010-20

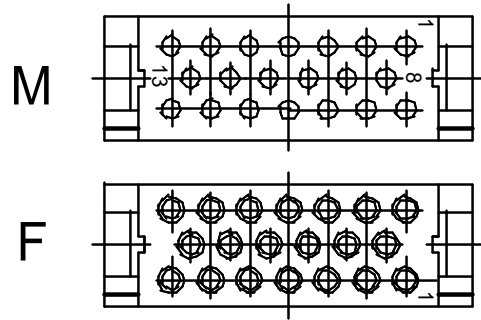

KBE-4020-20

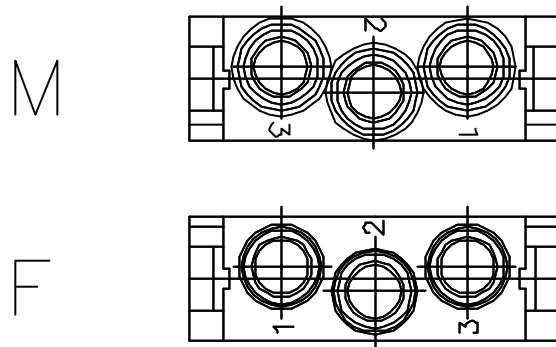

KBE-4020-21

view from cable side

A

C

L

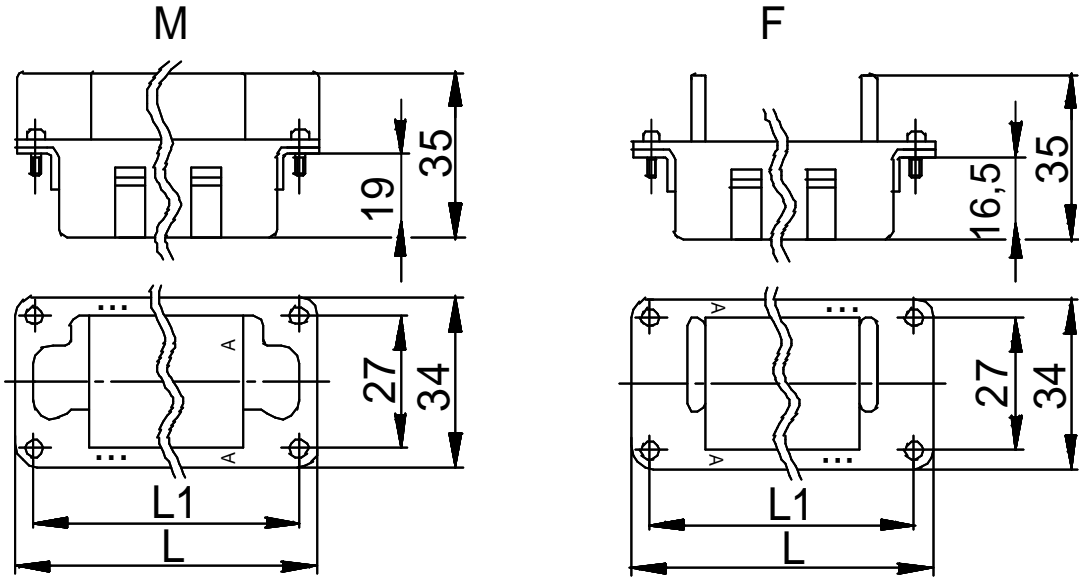

KBE-4000-60

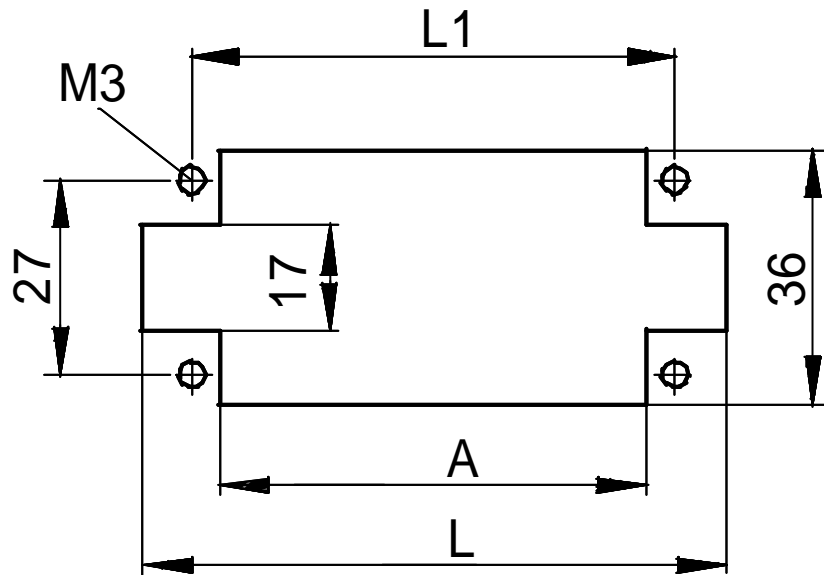

KBE-1000-30

A

C

L

Benennung	Art. Nr.	Version	Kontakte				Bild Nr.	Bild Nr.
Description	part No.	version	contacts	L	L1	H	picture No.	picture No.
Désignation	N° art.	version	contacts				page N°	page N°
MCS 3 Koax	10399200	male	3				KBE-4003-21	
MCB 3 Koax	10399300	female	3				KBE-4003-21	
MCS 5CG	10383200	male	4+PE				KBE-4005-25	
MCB 5 CG	10383300	female	4+PE				KBE-4005-25	
MCS 4 CM	10399000	male	4				KBE-4004-20	
MCB 4 CM	10399100	female	4				KBE-4004-20	
MCS 0 Blind	10399400	male	0				KBE-4000-20	
MCB 0 Blind	10399500	female	0				KBE-4000-20	
MCS 3 CM	10382000	male	3				KBE-4003-20	
MCB 3 CM	10382100	female	3				KBE-4003-20	
MCS 5 CM	10382200	male	5				KBE-4005-20	
MCB 5 CM	10382300	female	5				KBE-4005-20	
MCS 10 CM	10382400	male	10				KBE-4010-20	
MCB 10 CM	10382500	female	10				KBE-4010-20	
MCS 10 CG	10383400	male	10				KBE-4010-20	
MCB 10 CG	10383500	female	10				KBE-4010-20	
MCS 20 CM	10383600	male	20				KBE-4020-20	
MCB 20 CM	10383700	female	20				KBE-4020-20	
MCS 4 F	10399600	male	4				KBE-4003-22	
MCB 4 F	10399700	female	4				KBE-4003-22	
MCS 3 CM-HV	10399800	male	3				KBE-4020-21	
MCB 3 CM-HV	10399900	female	3				KBE-4020-21	
MCR 6	10381000	male	0-40	51	44		KBE-4000-60	KBE-1000-30
MCR 6	10381100	female	0-40	51	44		KBE-4000-60	KBE-1000-30
MCR 10	10381200	male	0-60	64	57		KBE-4000-60	KBE-1000-30
MCR 10	10381300	female	0-60	64	57		KBE-4000-60	KBE-1000-30
MCR 16	10381400	male	0-100	84,5	77,5		KBE-4000-60	KBE-1000-30
MCR 16	10381500	female	0-100	84,5	77,5		KBE-4000-60	KBE-1000-30
MCR 24	10381600	male	0-140	111	104		KBE-4000-60	KBE-1000-30
MCR 24	10381700	female	0-140	111	104		KBE-4000-60	KBE-1000-30
MCR 16+16	2x 10381400	male	0-200	84,5	77,5		KBE-4000-60	KBE-1100-30
MCR 16+16	2x 10381500	female	0-200	84,5	77,5		KBE-4000-60	KBE-1100-30
MCR 24+24	2x 10381600	male	0-280	111	104		KBE-4000-60	KBE-1100-30
MCR 24+24	2x 10381700	female	0-280	111	104		KBE-4000-60	KBE-1100-30

A

C

L

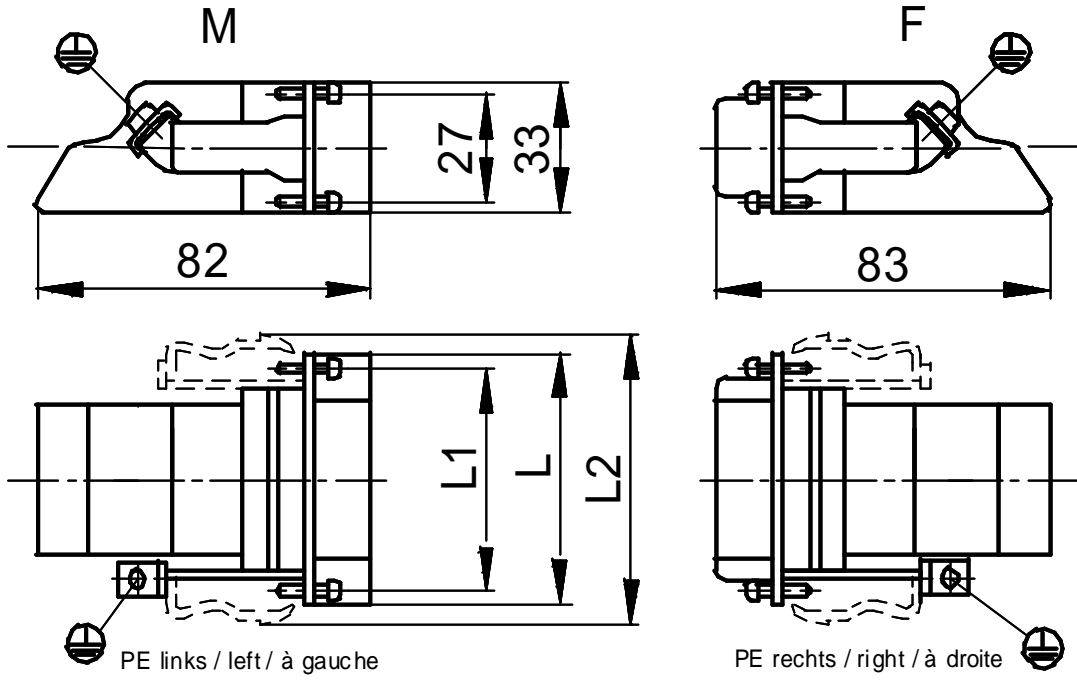

KBE-6000-60

A

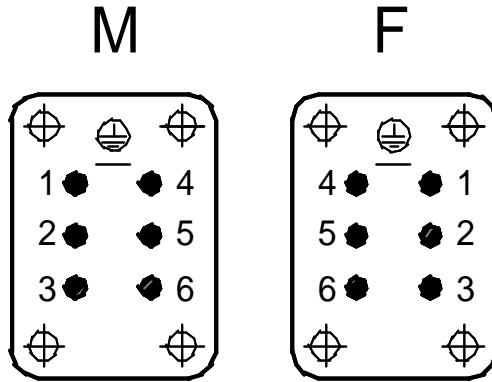

KBE-6006-20

C

L

view from cable side

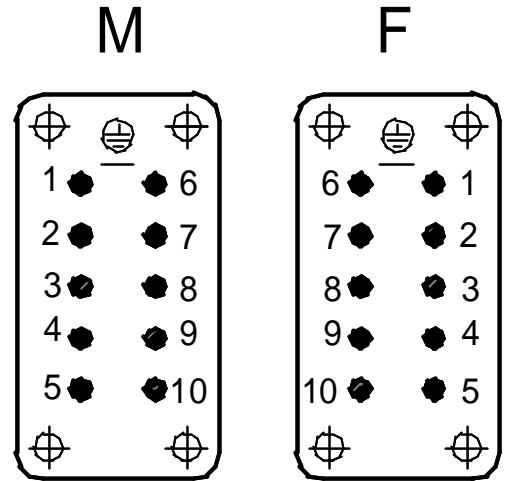

KBE-6010-20

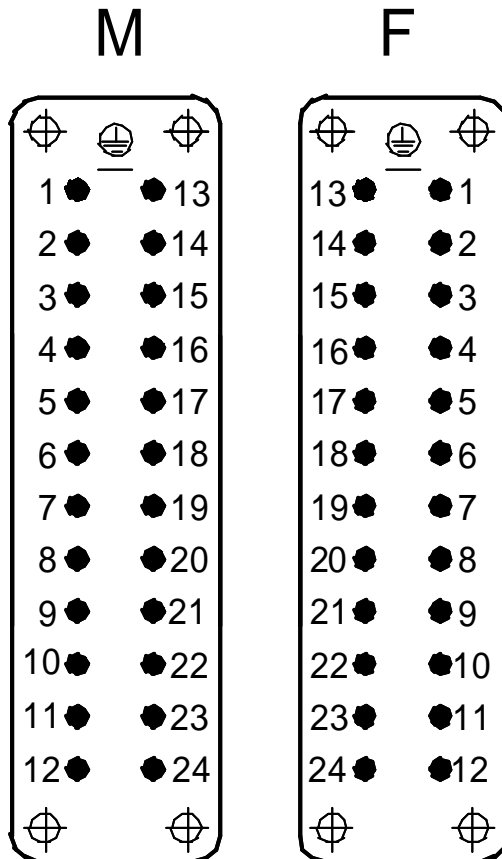

KBE-6024-20

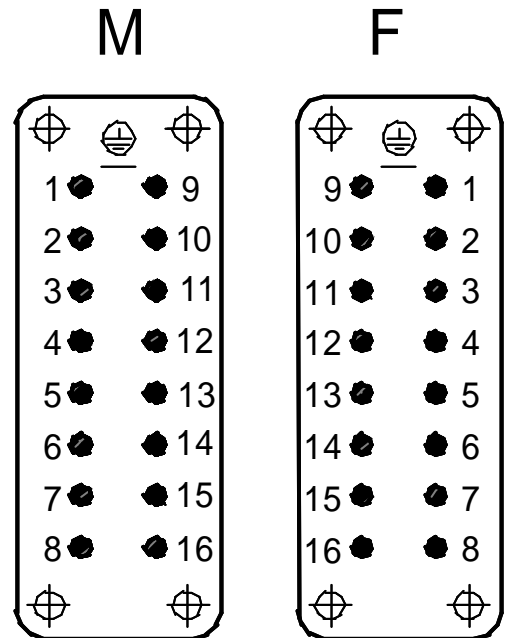

KBE-6016-20

view from cable side

A

C

L

Benennung	Art. Nr.	Version	Version	Kontakte	L	L1	L2	Bild Nr.	Bild Nr.
Description	part No.	version	version	contacts				picture No.	picture No.
Désignation	N° art.	version	version	contacts				page N°	page N°
TB-H-BE 6 SRE	70300000	male	right	6	49,8	44		KBE-6000-60	KBE-6006-20
TB-H-BE 6 BRE	70301100	female	right	6	49,8	44		KBE-6000-60	KBE-6006-20
TB-H-BE 6 SLI	70301000	male	left	6	49,8	44		KBE-6000-60	KBE-6006-20
TB-H-BE 6 BLI	70300100	female	left	6	49,8	44		KBE-6000-60	KBE-6006-20
TB-H-BE 6 SRE-RA	70300500	male	right	6	49,8	44	60	KBE-6000-60	KBE-6006-20
TB-H-BE 6 BRE-RA	70301600	female	right	6	49,8	44	60	KBE-6000-60	KBE-6006-20
TB-H-BE 6 SLI-RA	70301500	male	left	6	49,8	44	60	KBE-6000-60	KBE-6006-20
TB-H-BE 6 BLI-RA	70300600	female	left	6	49,8	44	60	KBE-6000-60	KBE-6006-20
TB-H-BE 10 SRE	70302000	male	right	10	63,2	57		KBE-6000-60	KBE-6010-20
TB-H-BE 10 BRE	70303100	female	right	10	63,2	57		KBE-6000-60	KBE-6010-20
TB-H-BE 10 SLI	70303000	male	left	10	63,2	57		KBE-6000-60	KBE-6010-20
TB-H-BE 10 BLI	70302100	female	left	10	63,2	57		KBE-6000-60	KBE-6010-20
TB-H-BE 10 SRE-RA	70302500	male	right	10	63,2	57	73	KBE-6000-60	KBE-6010-20
TB-H-BE 10 BRE-RA	70303600	female	right	10	63,2	57	73	KBE-6000-60	KBE-6010-20
TB-H-BE 10 SLI-RA	70303500	male	left	10	63,2	57	73	KBE-6000-60	KBE-6010-20
TB-H-BE 10 BLI-RA	70302600	female	left	10	63,2	57	73	KBE-6000-60	KBE-6010-20
TB-H-BE 16 SRE	70304000	male	right	16	83,3	77,5		KBE-6000-60	KBE-6016-20
TB-H-BE 16 BRE	70305100	female	right	16	83,3	77,5		KBE-6000-60	KBE-6016-20
TB-H-BE 16 SLI	70305000	male	left	16	83,3	77,5		KBE-6000-60	KBE-6016-20
TB-H-BE 16 BLI	70304100	female	left	16	83,3	77,5		KBE-6000-60	KBE-6016-20
TB-H-BE 16 SRE-RA	70304500	male	right	16	83,3	77,5	83	KBE-6000-60	KBE-6016-20
TB-H-BE 16 BRE-RA	70305600	female	right	16	83,3	77,5	83	KBE-6000-60	KBE-6016-20
TB-H-BE 16 SLI-RA	70305500	male	left	16	83,3	77,5	83	KBE-6000-60	KBE-6016-20
TB-H-BE 16 BLI-RA	70304600	female	left	16	83,3	77,5	83	KBE-6000-60	KBE-6016-20
TB-H-BE 24 SRE	70306000	male	right	24	110,1	104		KBE-6000-60	KBE-6024-20
TB-H-BE 24 BRE	70307100	female	right	24	110,1	104		KBE-6000-60	KBE-6024-20
TB-H-BE 24 SLI	70307000	male	left	24	110,1	104		KBE-6000-60	KBE-6024-20
TB-H-BE 24 BLI	70306100	female	left	24	110,1	104		KBE-6000-60	KBE-6024-20
TB-H-BE 24 SRE-RA	70306500	male	right	24	110,1	104	120	KBE-6000-60	KBE-6024-20
TB-H-BE 24 BRE-RA	70307600	female	right	24	110,1	104	120	KBE-6000-60	KBE-6024-20
TB-H-BE 24 SLI-RA	70307500	male	left	24	110,1	104	120	KBE-6000-60	KBE-6024-20
TB-H-BE 24 BLI-RA	70306600	female	left	24	110,1	104	120	KBE-6000-60	KBE-6024-20

A

C

L

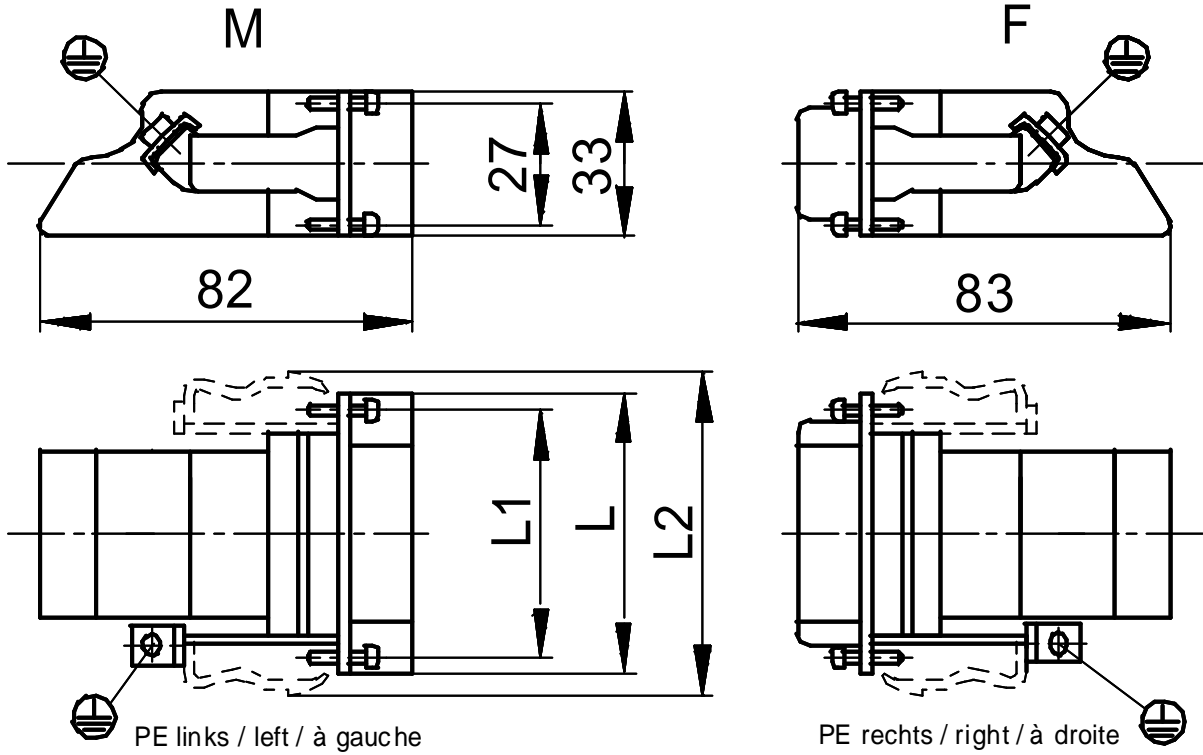

KBE-6000-60

A

M

F

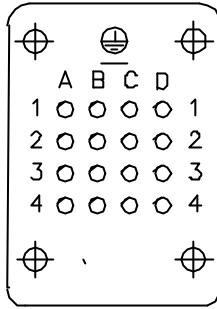
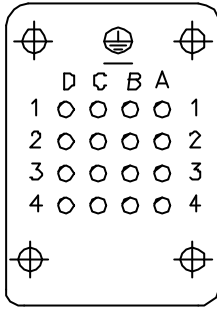

KDE-6016-20

C

L

view from cable side

M

F

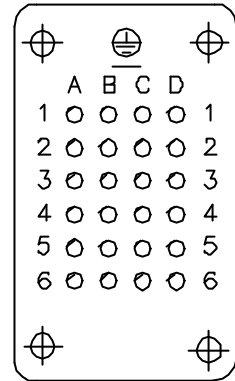
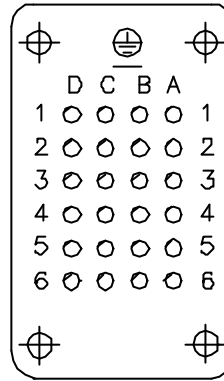

view from cable side

KDE-6024-20

M

F

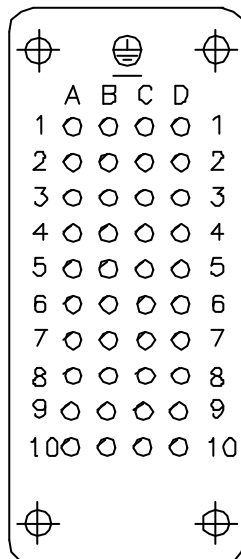
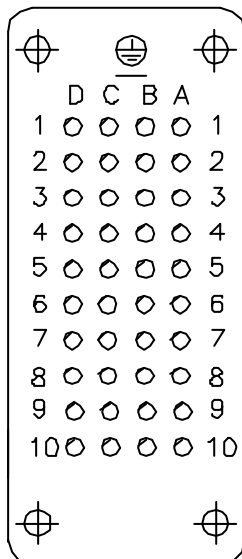

KDE-6040-20

A

C

L

view from cable side

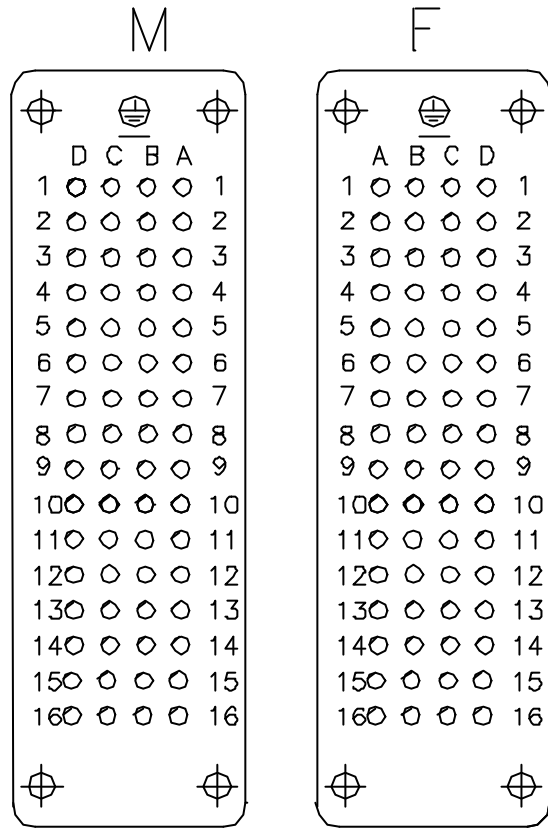

KDE-6064-20

A

C

L

Benennung Description Désignation	Art. Nr. part No. N° art.	Version version version	Version version version	Kontakte contacts contacts	L	L1	L2	Bild Nr. picture No. page N°	Bild Nr. picture No. page N°
TB-H-D 16 SRE	71300000	male	right	16	49,8	44		KDE-6000-60	KDE-6016-20
TB-H-D 16 BRE	71301100	female	right	16	49,8	44		KDE-6000-60	KDE-6016-20
TB-H-D 16 SLI	71301000	male	left	16	49,8	44		KDE-6000-60	KDE-6016-20
TB-H-D 16 BLI	71300100	female	left	16	49,8	44		KDE-6000-60	KDE-6016-20
TB-H-D 16 SRE-RA	71300500	male	right	16	49,8	44	58,6	KDE-6000-60	KDE-6016-20
TB-H-D 16 BRE-RA	71301600	female	right	16	49,8	44	58,6	KDE-6000-60	KDE-6016-20
TB-H-D 16 SLI-RA	71301500	male	left	16	49,8	44	58,6	KDE-6000-60	KDE-6016-20
TB-H-D 16 BLI-RA	71300600	female	left	16	49,8	44	58,6	KDE-6000-60	KDE-6016-20
TB-H-D 24 SRE	71302000	male	right	24	63,2	57		KDE-6000-60	KDE-6024-20
TB-H-D 24 BRE	71303100	female	right	24	63,2	57		KDE-6000-60	KDE-6024-20
TB-H-D 24 SLI	71303000	male	left	24	63,2	57		KDE-6000-60	KDE-6024-20
TB-H-D 24 BLI	71302100	female	left	24	63,2	57		KDE-6000-60	KDE-6024-20
TB-H-D 24 SRE-RA	71302500	male	right	24	63,2	57	72	KDE-6000-60	KDE-6024-20
TB-H-D 24 BRE-RA	71303600	female	right	24	63,2	57	72	KDE-6000-60	KDE-6024-20
TB-H-D 24 SLI-RA	71303500	male	left	24	63,2	57	72	KDE-6000-60	KDE-6024-20
TB-H-D 24 BLI-RA	71302600	female	left	24	63,2	57	72	KDE-6000-60	KDE-6024-20
TB-H-D 40 SRE	71304000	male	right	40	83,3	77,5		KDE-6000-60	KDE-6040-20
TB-H-D 40 BRE	71305100	female	right	40	83,3	77,5		KDE-6000-60	KDE-6040-20
TB-H-D 40 SLI	71305000	male	left	40	83,3	77,5		KDE-6000-60	KDE-6040-20
TB-H-D 40 BLI	71304100	female	left	40	83,3	77,5		KDE-6000-60	KDE-6040-20
TB-H-D 40 SRE-RA	71304500	male	right	40	83,3	77,5	92,2	KDE-6000-60	KDE-6040-20
TB-H-D 40 BRE-RA	71305600	female	right	40	83,3	77,5	92,2	KDE-6000-60	KDE-6040-20
TB-H-D 40 SLI-RA	71305500	male	left	40	83,3	77,5	92,2	KDE-6000-60	KDE-6040-20
TB-H-D 40 BLI-RA	71304600	female	left	40	83,3	77,5	92,2	KDE-6000-60	KDE-6040-20
TB-H-D 64 SRE	71306000	male	right	64	110,1	104		KDE-6000-60	KDE-6064-20
TB-H-D 64 BRE	71307100	female	right	64	110,1	104		KDE-6000-60	KDE-6064-20
TB-H-D 64 SLI	71307000	male	left	64	110,1	104		KDE-6000-60	KDE-6064-20
TB-H-D 64 BLI	71306100	female	left	64	110,1	104		KDE-6000-60	KDE-6064-20
TB-H-D 64 SRE-RA	71306500	male	right	64	110,1	104	119	KDE-6000-60	KDE-6064-20
TB-H-D 64 BRE-RA	71307600	female	right	64	110,1	104	119	KDE-6000-60	KDE-6064-20
TB-H-D 64 SLI-RA	71307500	male	left	64	110,1	104	119	KDE-6000-60	KDE-6064-20
TB-H-D 64 BLI-RA	71306600	female	left	64	110,1	104	119	KDE-6000-60	KDE-6064-20

A

C

L

Tgv without or with Pg 11

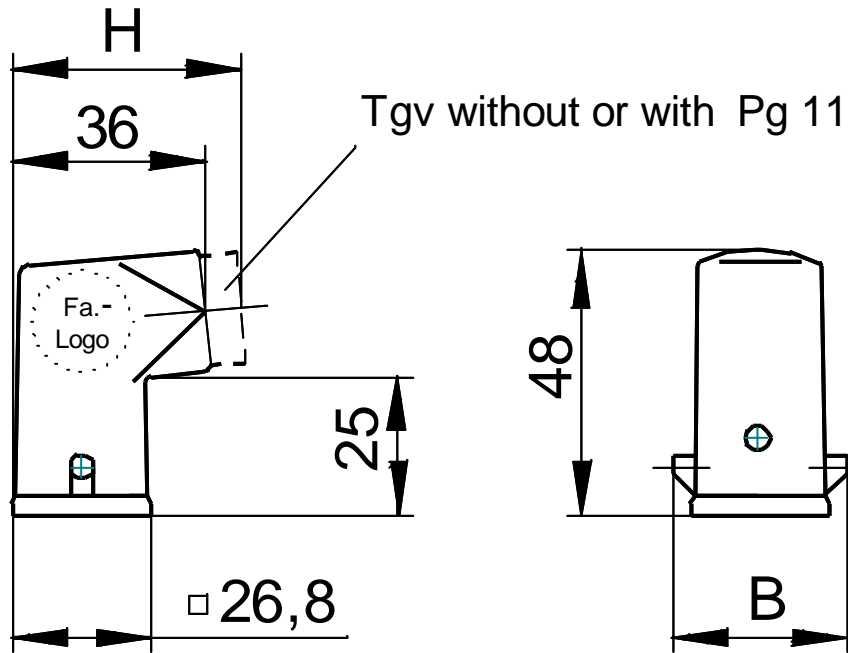
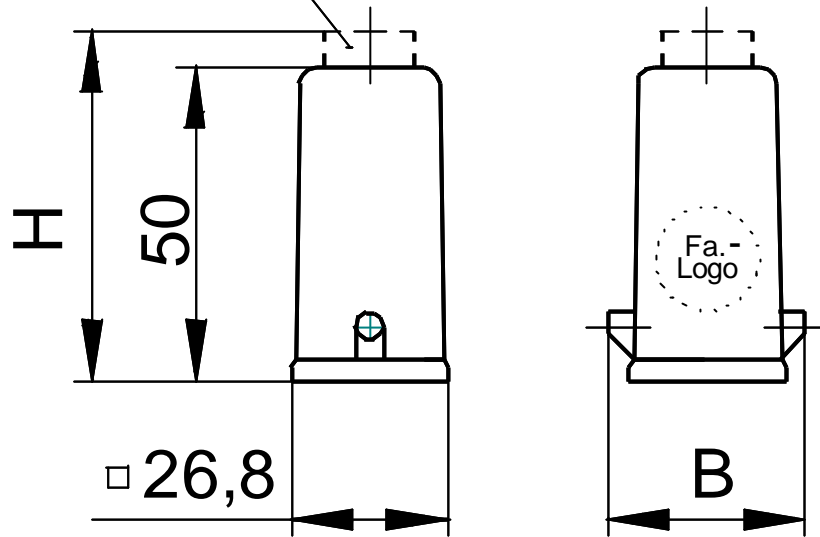

KAG-0015-00 + KAG-0025-00

A

C

L

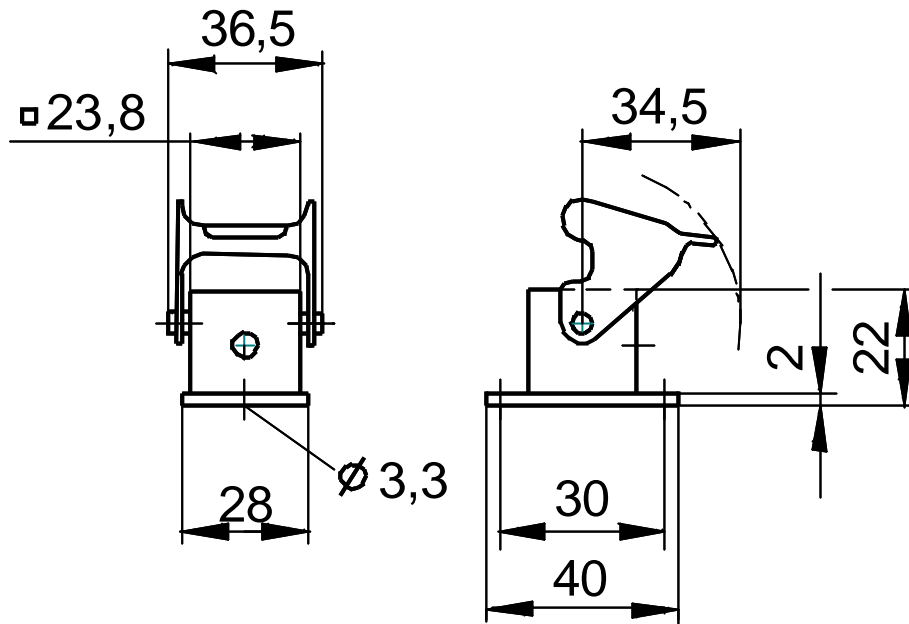

KAG-0205-00

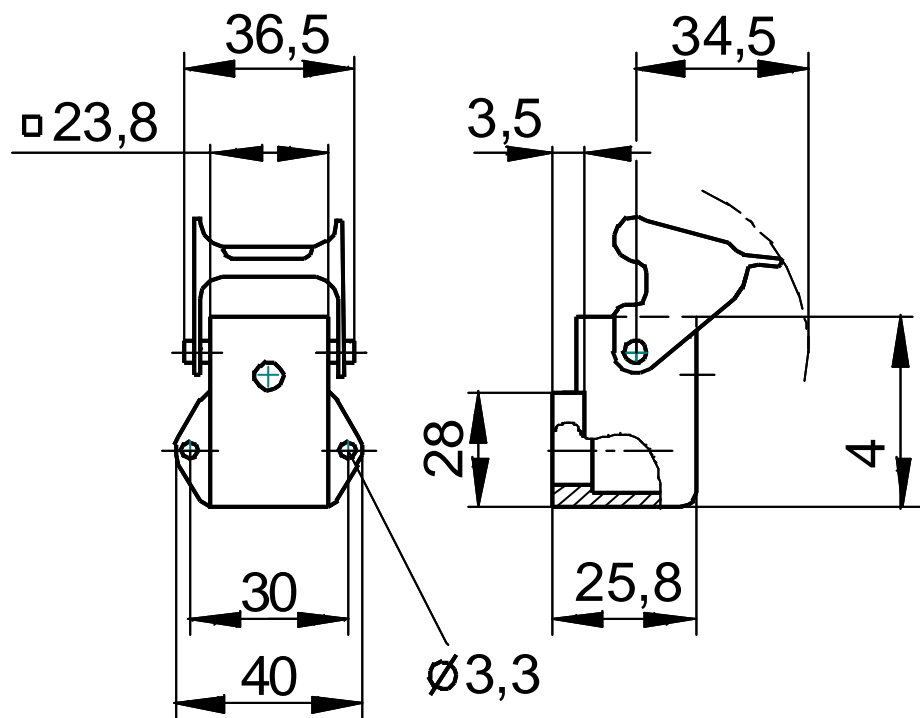

KAG-0206-00

A

C

L

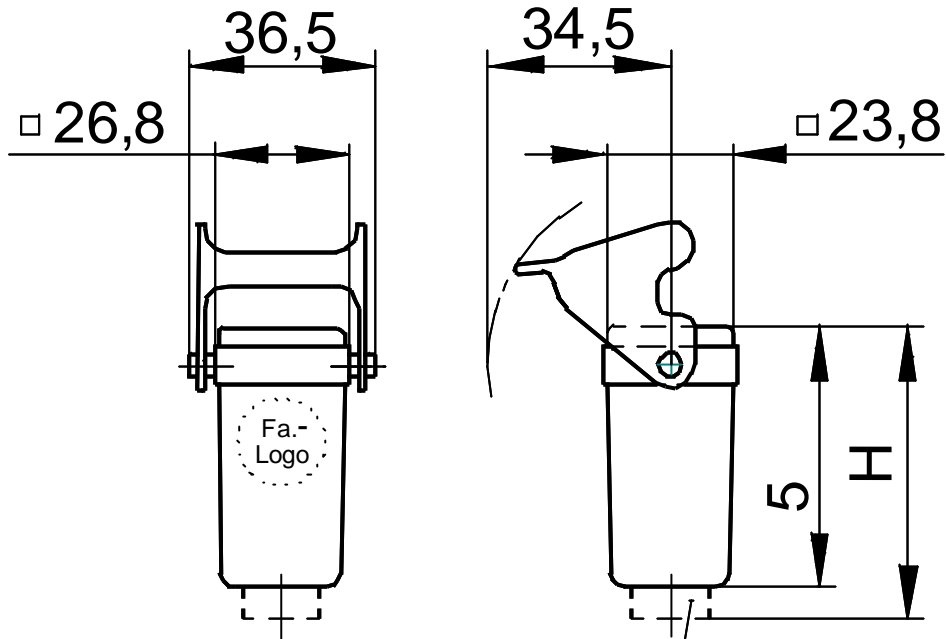

Tgvb without or with Pg 11

KAG-0105-00

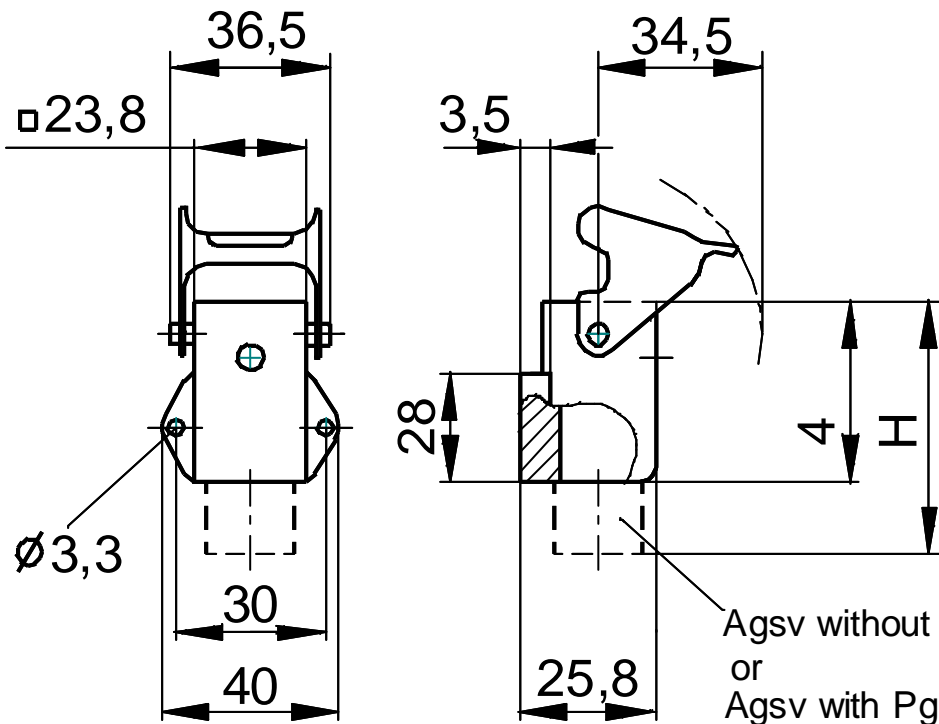

Agsv without Pg 11
or
Agsv with Pg 11

KAG-0165-00

A

C

L

Benennung Description Désignation	Art. Nr. part No. N° art.	Version version version	Version version version	Version version version	Version version version	PG size PG Größe PG	B	H	Bild Nr. picture No. page N°
H-A 3 MTgv	10512100	without PG	top	metal	black	11	33,5		KAG-0015-00
H-A 3 Tgv	10425500	without PG	top	plastic	black	11	36		KAG-0015-00
H-A 3 Tgv	10426000	without PG	top	plastic	grey	11	36		KAG-0015-00
H-A 3 MTgv	10620600	with PG	top	metal	black	11	33,5	57	KAG-0015-00
H-A 3 Tgv	10427100	with PG	top	plastic	black	11	36	62	KAG-0015-00
H-A 3 Tgv	10512900	with PG	top	plastic	grey	11	36	62	KAG-0015-00
H-A 3 MTs	10512300	without PG	side	metal	black	11	33,5		KAG-0025-00
H-A 3 Ts	10427300	without PG	side	plastic	black	11	36		KAG-0025-00
H-A 3 Ts	10427000	without PG	side	plastic	grey	11	36		KAG-0025-00
H-A 3 MTs	10427500	with PG	side	metal	black	11	33,5	43	KAG-0025-00
H-A 3 Ts	10620600	with PG	side	plastic	black	11	36	48	KAG-0025-00
H-A 3 Ts	10427100	with PG	side	plastic	grey	11	36	48	KAG-0025-00
H-A 3 MAg	10422500			metal	black				KAG-0205-00
H-A 3 Ag	10422200			plastic	black				KAG-0205-00
H-A 3 Ag	10422000			plastic	grey				KAG-0205-00
H-A 3 MAg	10423500			metal	black				KAG-0206-00
H-A 3 Ag	10423100			plastic	black				KAG-0206-00
H-A 3 Ag	10423000			plastic	grey				KAG-0206-00
H-A 3 MAgsv	10512700	without PG		metal	black			51,5	KAG-0105-00
H-A 3 Agsv	10511700	without PG		plastic	black			56	KAG-0105-00
H-A 3 Agsv	10424000	without PG		plastic	grey			56	KAG-0105-00
H-A 3 MAgsv	10424500	with PG		metal	black			57,5	KAG-0105-00
H-A 3 Agsv	10424700	with PG		plastic	black			65	KAG-0105-00
H-A 3 Agsv	10424200	with PG		plastic	grey			65	KAG-0105-00
H-A 3 MTgvb	10512900	without PG	top	metal	black	11			KAG-0165-00
H-A 3 Tgvb	10429200	without PG	top	plastic	black	11			KAG-0165-00
H-A 3 Tgvb	10429000	without PG	top	plastic	grey	11			KAG-0165-00
H-A 3 MTgvb	10429500	with PG	top	metal	black	11		60	KAG-0165-00
H-A 3 Tgvb	10620300	with PG	top	plastic	black	11		65	KAG-0165-00
H-A 3 Tgvb	10429100	with PG	top	plastic	grey	11		65	KAG-0165-00

A

C

L

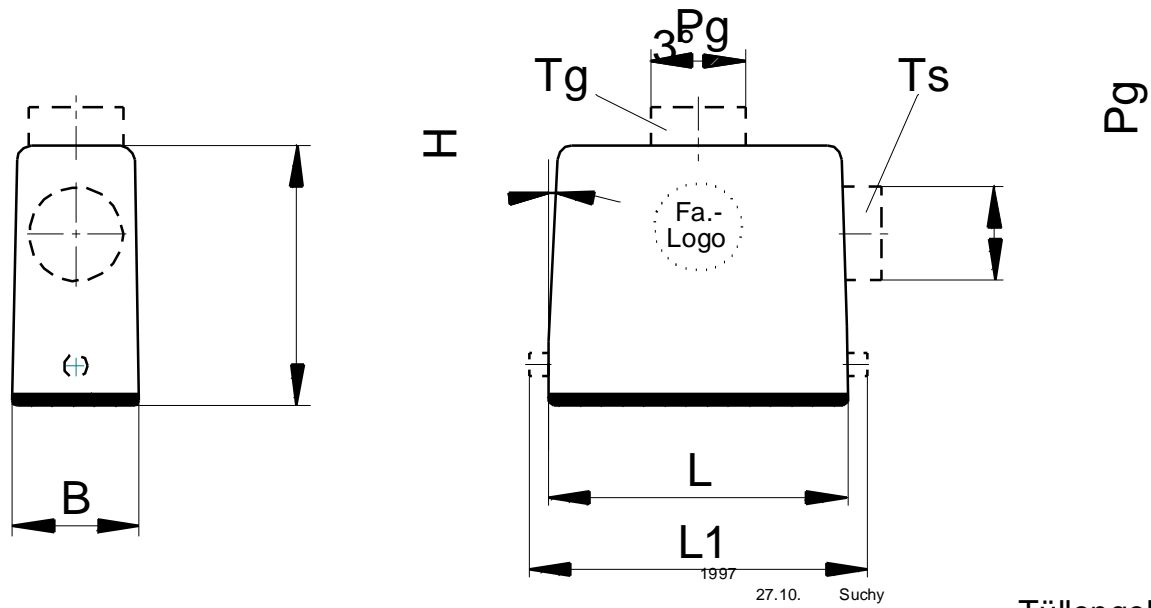

Tüllengehäuse

KAG-0020-00

01 -----

A

C

L

Benennung	Art. Nr.	Art. Nr.	Kabel Eingang	PG	L	L1	B	H
Description	part No.	part No.	Cable entry					
Désignation	N° art.	N° art.	sortie					
H-A 10 TS 16 ZW.	10445000		seitlich, side, latérale	16	63	73	29,5	53,3
H-A 10 TS-K 16 ZW.		70463000	seitlich, side, latérale	16	63	73	29,5	53,3
H-A 10 TG 16 ZW.	10446100		gerade, top, verticale	16	63	73	29,5	53,3
H-A 10 TG-K 16 ZW.		70461000	gerade, top, verticale	16	63	73	29,5	53,3
H-A 16 TS 16 ZW.	10564000		seitlich, side, latérale	16	79	89	29,5	58,3
H-A 16 TS-K 16 ZW.		70493000	seitlich, side, latérale	16	79	89	29,5	58,3
H-A 16 TG 16 ZW.	10565000		gerade, top, verticale	16	79	89	29,5	58,3
H-A 16 TG-K 16 ZW.		70491000	gerade, top, verticale	16	79	89	29,5	58,3
H-A 10 TSH 16	70462200		seitlich, side, latérale	16	63	73	29,5	67,3
H-A 10 TS 16 ZW.	10445000		seitlich, side, latérale	16	63	73	29,5	53,3
H-A 10 TS-K 16 ZW.		70463000	seitlich, side, latérale	16	63	73	29,5	53,3
H-A 10 TG 16 ZW.	10446100		gerade, top, verticale	16	63	73	29,5	53,3
H-A 10 TG-K 16 ZW.		70461000	gerade, top, verticale	16	63	73	29,5	53,3
H-A 10 TSH 21	70462400		seitlich, side, latérale	21	63	73	29,5	67,3
H-A 10 TSH-K 16		70463200	seitlich, side, latérale	16	63	73	29,5	67,3
H-A 10 TSH-K 21		70463400	seitlich, side, latérale	21	63	73	29,5	67,3
H-A 10 TGH 16	70460200		gerade, top, verticale	16	63	73	29,5	67,3
H-A 10 TGH 21	70460400		gerade, top, verticale	21	63	73	29,5	67,3
H-A 10 TGH-K 16		70461200	gerade, top, verticale	16	63	73	29,5	67,3
H-A 10 TGH-K 21		70461400	gerade, top, verticale	21	63	73	29,5	67,3
H-A 16 TS 16 ZW.	10564000		seitlich, side, latérale	16	79	89	29,5	58,3
H-A 16 TS-K 16 ZW.		70493000	seitlich, side, latérale	16	79	89	29,5	58,3
H-A 16 TG 16 ZW.	10565000		gerade, top, verticale	16	79	89	29,5	58,3
H-A 16 TG-K 16 ZW.		70491000	gerade, top, verticale	16	79	89	29,5	58,3
H-A 16 TSH 16 ZW.	70492200		seitlich, side, latérale	16	79	89	29,5	72,3
H-A 16 TSH 21 ZW.	70492400		seitlich, side, latérale	21	79	89	29,5	72,3
H-A 16 TSH-K 16 ZW.		70493200	seitlich, side, latérale	16	79	89	29,5	72,3
H-A 16 TSH-K 21 ZW.		70493400	seitlich, side, latérale	21	79	89	29,5	72,3
H-A 16 TGH 16 ZW.	70490200		gerade, top, verticale	16	79	89	29,5	72,3
H-A 16 TGH 21 ZW.	70490400		gerade, top, verticale	21	79	89	29,5	72,3
H-A 16 TGH-K 16 ZW.		70491200	gerade, top, verticale	16	79	89	29,5	72,3
H-A 16 TGH-K 21 ZW.		70491400	gerade, top, verticale	21	79	89	29,5	72,3
H-A 32 TS 21 ZW	10576000		seitlich, side, latérale	21	82	49,6	56	70,8
H-A 32 TS 29 ZW.	10577000		seitlich, side, latérale	29	82	49,6	56	70,8
H-A 32 TS-K 21 ZW.		70523200	seitlich, side, latérale	21	82	49,6	56	70,8
H-A 32 TS-K 29 ZW.		70523400	seitlich, side, latérale	29	82	49,6	56	70,8
H-A 32 TG 21 ZW.	10582000		gerade, top, verticale	21	82	49,6	56	70,8
H-A 32 TG 29 ZW.	10583000		gerade, top, verticale	29	82	49,6	56	70,8
H-A 32 TG-K 21 ZW.		70521200	gerade, top, verticale	21	82	49,6	56	70,8
H-A 32 TG-K 29 ZW.		70521400	gerade, top, verticale	29	82	49,6	56	70,8
H-A 48 TS 29 ZW.	10630800		seitlich, side, latérale	29	93,5	64,5	79	89,5
H-A 48 TG 29 ZW.	10631800		gerade, top, verticale	29	93,5	64,5	79	89,5

A

C

L

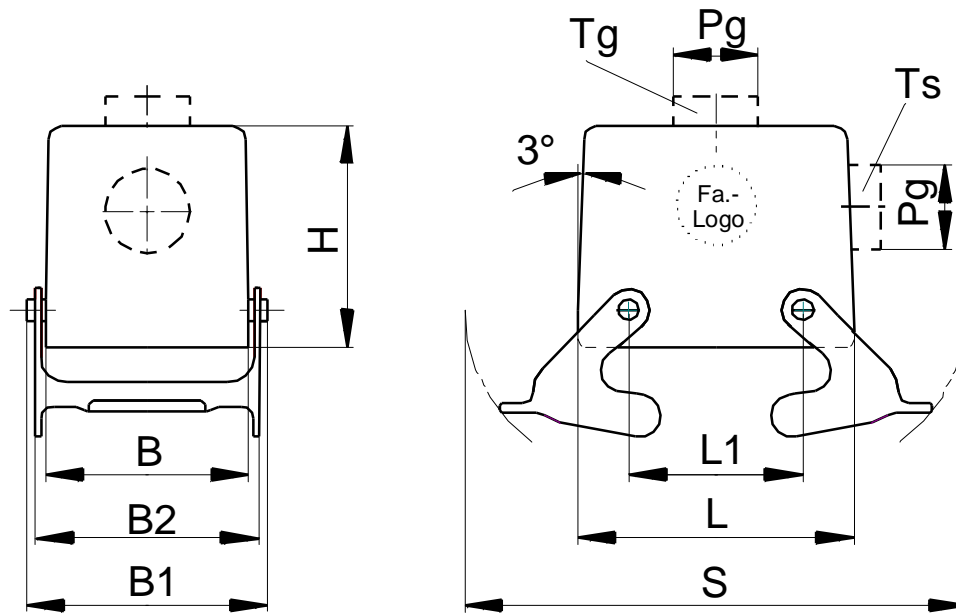

Tüllengehäuse
mit QB

KBG-0040-00

A

C

L

Benennung	Art. Nr.	Art. Nr.	Kabel Eingang	PG	L	L1	B	B1	B2	H	S
Description	part No.	part No.	Cable entry								
Désignation	N° art.	N° art.	sortie								
H-A 32 TSB 21 ZW.	10578000		seitlich, side, latérale	21	82	49,6	56	70,8	66	75	124,5
H-A 32 TSB 29 ZW.	10579000		seitlich, side, latérale	29	82	49,6	56	70,8	66	75	124,5
H-A 32 TSB-K 21 ZW.		70528200	seitlich, side, latérale	21	82	49,6	56	70,8	66	75	124,5
H-A 32 TSB-K 29 ZW.		70528400	seitlich, side, latérale	29	82	49,6	56	70,8	66	75	124,5
H-A 32 TGB 21 ZW.	10584000		gerade, top, verticale	21	82	49,6	56	70,8	66	75	124,5
H-A 32 TGB 29 ZW.	10585000		gerade, top, verticale	29	82	49,6	56	70,8	66	75	124,5
H-A 32 TGB-K 21 ZW.		70526200	gerade, top, verticale	21	82	49,6	56	70,8	66	75	124,5
H-A 32 TGB-K 29 ZW.		70526400	gerade, top, verticale	29	82	49,6	56	70,8	66	75	124,5

A

C

L

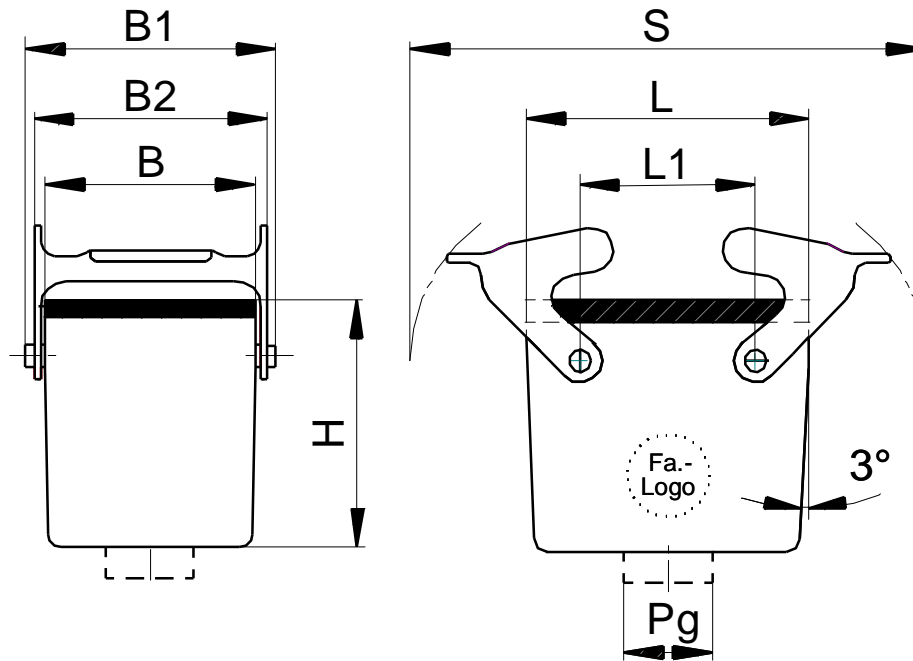

1997
07.11. Suchy

Kupplungsgehäuse
mit QB

KBG-0080-00

01 -----

A

C

L

Benennung	Art. Nr.	Art. Nr.	Kabel Eingang	PG	L	L1	B	B1	B2	H	S
Description	part No.	part No.	Cable entry								
Désignation	N° art.	N° art.	sortie								
H-A 32 TBF 21 ZW.	10588000		gerade, top, verticale	21	82	49,6	56	70,8	66	76,5	124,5
H-A 32 TBF 29 ZW.	10588500		gerade, top, verticale	29	82	49,6	56	70,8	66	76,5	124,5
H-A 32 TBF-K 21 ZW.		70511000	gerade, top, verticale	21	82	49,6	56	70,8	66	76,5	124,5
H-A 32 TBF-K 29 ZW.		70511200	gerade, top, verticale	29	82	49,6	56	70,8	66	76,5	124,5

A

C

L

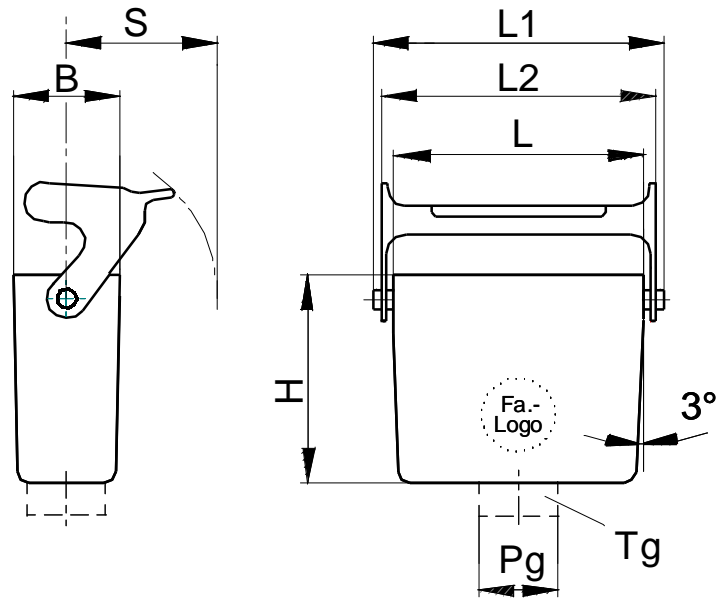

1997
27.10. Suchy

Kuplung mit LB

KAG-0100-00

01 -----

A

C

L

Benennung	Art. Nr.	Art. Nr.	Kabel Eingang	PG	L	L1	L2	B	H	S
Description	part No.	part No.	Cable entry							
Désignation	N° art.	N° art.	sortie							
H-A 10 TBF-LB 16 ZW.	70450000		gerade, top, verticale	16	63	74,4	71,4	29,5	48	36,5
H-A 10 TBF-LB-K 16 ZW.		70451000	gerade, top, verticale	16	63	74,4	71,4	29,5	48	36,5
H-A 16 TBF-LB 16 ZW.	10563000		gerade, top, verticale	16	79	90,4	87,8	29,5	53	36,5
H-A 16 TBF-LB-K 16 ZW.		70481000	gerade, top, verticale	16	79	90,4	87,8	29,5	53	36,5
H-A 10 TBF-LB 16 ZW.	70450000		gerade, top, verticale	16	63	74,4	71,4	29,5	48	36,5
H-A 10 TBF-LB-K 16 ZW.		70451000	gerade, top, verticale	16	63	74,4	71,4	29,5	48	36,5
H-A 10 TBFH-LB-K 16 ZW.		70451200	gerade, top, verticale	16	63	74,4	71,4	29,5	62	36,5
H-A 10 TBFH-LB-K 21 ZW.		70451400	gerade, top, verticale	21	63	74,4	71,4	29,5	62	36,5
H-A 16 TBFH-LB 16 ZW.	70480200		gerade, top, verticale	16	79	90,4	87,8	29,5	67	36,5
H-A 16 TBF-LB 16 ZW.	10563000		gerade, top, verticale	16	79	90,4	87,8	29,5	53	36,5
H-A 16 TBF-LB-K 16 ZW.		70481000	gerade, top, verticale	16	79	90,4	87,8	29,5	53	36,5
H-A 16 TBFH-LB 21 ZW.	70480400		gerade, top, verticale	21	79	90,4	87,8	29,5	67	36,5
H-A 16 TBFH-LB-K 16 ZW.		70481200	gerade, top, verticale	16	79	90,4	87,8	29,5	67	36,5
H-A 16 TBFH-LB-K 21 ZW.		70481400	gerade, top, verticale	21	79	90,4	87,8	29,5	67	36,5

A

C

L

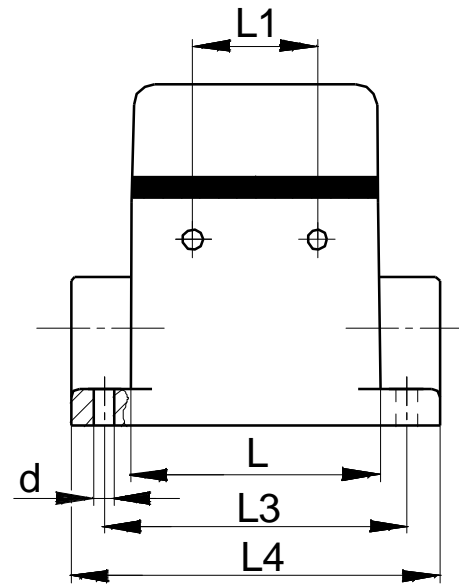
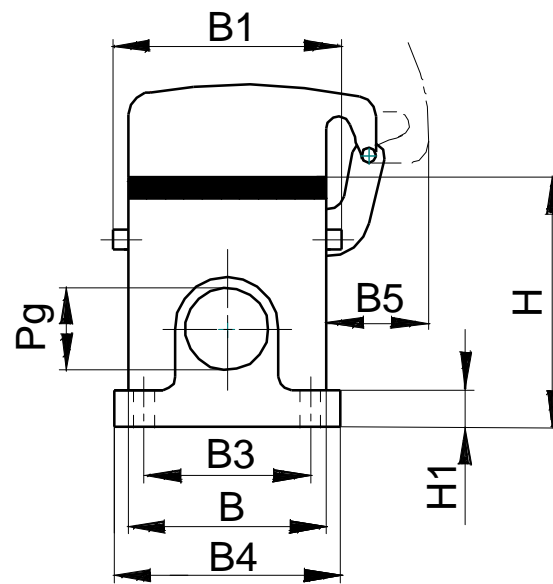

1997
07.11. Suchy

Sockelgehäuse
mit Deckel (ohne Bügel)

KBG-0120-00

01 -----

A

C

L

Benennung Description Désignation	Art. Nr. part No. N° art.	Art. Nr. part No. N° art.	Kabel Eingang Cable entry sortie	PG	L	L1	L3	L4	B	B1	B3	B4	B5	H	H1	d
H-A 32 SDRL-BO 21 ZW	70516200		2	21	82	49,6	94	106	56	70,8	46	57	29	75	4	5,5
H-A 32 SDRL-BO 29 ZW	70516400		2	29	82	49,6	94	106	56	70,8	46	57	29	75	4	5,5
H-A 32 SDRL-BO-K 21 ZW		70518200	2	21	82	49,6	94	106	56	70,8	46	57	29	75	4	5,5
H-A 32 SDRL-BO-K 29 ZW		70518400	2	29	82	49,6	94	106	56	70,8	46	57	29	75	4	5,5
H-A 32 SDR-BO 21 ZW	70515200		1	21	82	49,6	94	106	56	70,8	46	57	29	75	4	5,5
H-A 32 SDR-BO 29 ZW.	70515400		1	29	82	49,6	94	106	56	70,8	46	57	29	75	4	5,5
H-A 32 SDR-BO-K 21 ZW		70517200	1	21	82	49,6	94	106	56	70,8	46	57	29	75	4	5,5
H-A 32 SDR-BO-K 29 ZW		70517400	1	29	82	49,6	94	106	56	70,8	46	57	29	75	4	5,5

A

C

L

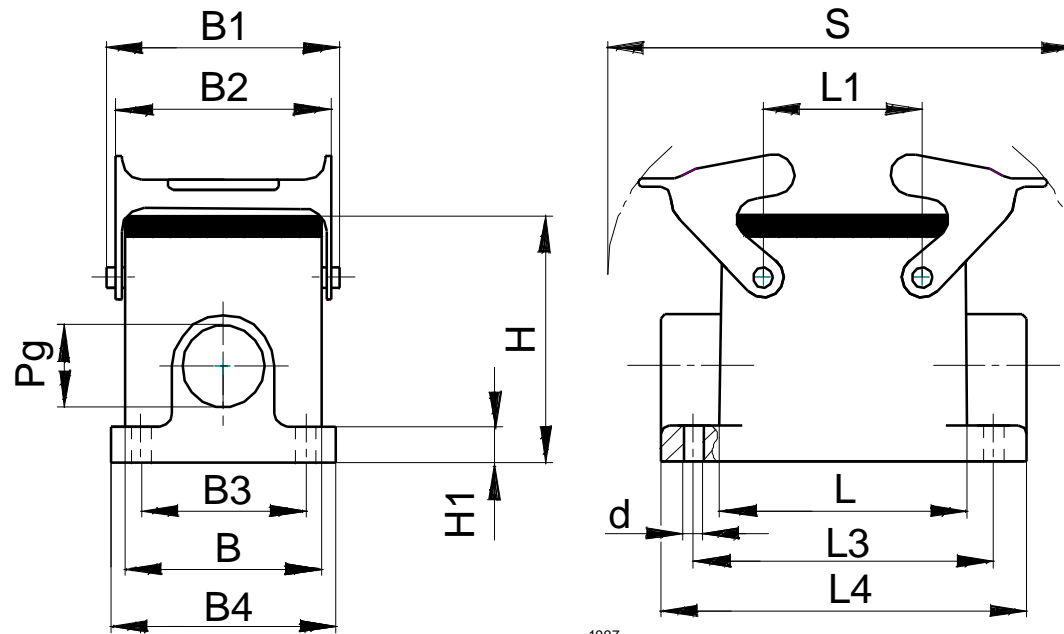

1997
28.10. Suchy

Sockelgehäuse
mit QB (ohne Deckel)

KBG-0140-00

01 - - - -

A

C

L

Benennung Description Désignation	Art. Nr. part No. N° art.	Art. Nr. part No. N° art.	Kabel Eingang Cable entry sortie	PG	L	L1	L3	L4	B	B1	B2	B3	B4	H	H1	S	d
H-A 32 SGRL 21 ZW.	10482000		2	21	82	49,6	94	106	56	70,8	66	46	57	75	4	124,5	5,5
H-A 32 SGRL 29 ZW.	10482100		2	29	82	49,6	94	106	56	70,8	66	46	57	75	4	124,5	5,5
H-A 32 SGRL-K 21 ZW.		70508200	2	21	82	49,6	94	106	56	70,8	66	46	57	75	4	124,5	5,5
H-A 32 SGRL-K 29 ZW.		70508400	2	29	82	49,6	94	106	56	70,8	66	46	57	75	4	124,5	5,5
H-A 32 SGR 21 ZW.	10474000		1	21	82	49,6	94	106	56	70,8	66	46	57	75	4	124,5	5,5
H-A 32 SGR 29 ZW.	10474100		1	29	82	49,6	94	106	56	70,8	66	46	57	75	4	124,5	5,5
H-A 32 SGR-K 21 ZW.		70507200	1	21	82	49,6	94	106	56	70,8	66	46	57	75	4	124,5	5,5
H-A 32 SGR-K 29 ZW.		70507400	1	29	82	49,6	94	106	56	70,8	66	46	57	75	4	124,5	5,5
H-A 48 SGRL 29 ZW.	10634800		2	29	93,5	64,5	112	124,5	79	91	87,8	67	81	72	5	136,5	5,5
H-A 48 SGR 29 ZW.	10633800		1	29	93,5	64,5	112	124,5	79	91	87,8	67	81	72	5	136,5	5,5

A

C

L

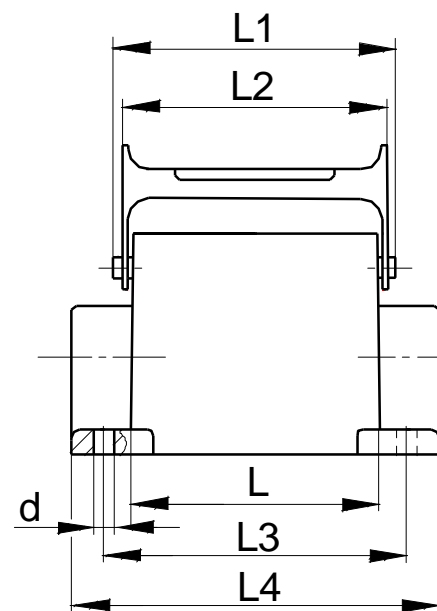
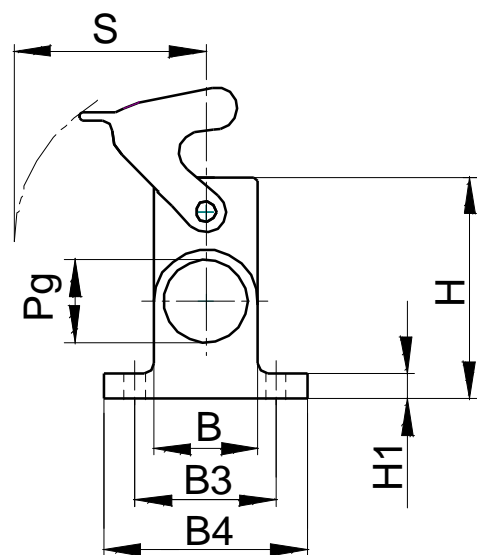

1997
27.10. Suchy

Sockelgehäuse
mit LB

KAG-0160-00

01 -----

A

C

L

Benennung Description Désignation	Art. Nr. part No. N° art.	Art. Nr. part No. N° art.	Kabel Eingang Cable entry sortie	PG	L	L1	L2	L3	L4	B	B3	B4	B5	H	H1	S	d
H-A 10 SGRL-LB 16 ZW.	10450100		2	16	63	74,4	71,4	48	80	29,5	40		50	57	3,5	36,5	4,5
H-A 10 SGRL-LB 21 ZW.	10450000		2	21	63	74,4	71,4	48	80	29,5	40		50	57	3,5	36,5	4,5
H-A 10 SGRL-LB-K 16 ZW.		70448200	2	16	63	74,4	71,4	48	80	29,5	40		50	57	3,5	36,5	4,5
H-A 10 SGRL-LB-K 21 ZW.		70448400	2	21	63	74,4	71,4	48	80	29,5	40		50	57	3,5	36,5	4,5
H-A 10 SGR-LB 16 ZW.	10448100		1	16	63	74,4	71,4	48	80	29,5	40		50	57	3,5	36,5	4,5
H-A 10 SGR-LB 21 ZW.	10448000		1	21	63	74,4	71,4	48	80	29,5	40		50	57	3,5	36,5	4,5
H-A 10 SGR-LB-K 16 ZW.		70447200	1	16	63	74,4	71,4	48	80	29,5	40		50	57	3,5	36,5	4,5
H-A 10 SGR-LB-K 21 ZW.		70447400	1	21	63	74,4	71,4	48	80	29,5	40		50	57	3,5	36,5	4,5
H-A 16 SGRL-LB 16 ZW.	10568100		2	16	79	90,4	87,8	64	96	29,5	40	50		57	3,5	36,5	4,5
H-A 16 SGRL-LB 21 ZW.	10568000		2	21	79	90,4	87,8	64	96	29,5	40	50		57	3,5	36,5	4,5
H-A 16 SGRL-LB-K 16 ZW.		70478200	2	16	79	90,4	87,8	64	96	29,5	40	50		57	3,5	36,5	4,5
H-A 16 SGRL-LB-K 21 ZW.		70478400	2	21	79	90,4	87,8	64	96	29,5	40	50		57	3,5	36,5	4,5
H-A 16 SGR-LB 16 ZW.	10567100		1	16	79	90,4	87,8	64	96	29,5	40	50		57	3,5	36,5	4,5
H-A 16 SGR-LB 21 ZW.	10567000		1	21	79	90,4	87,8	64	96	29,5	40	50		57	3,5	36,5	4,5
H-A 16 SGR-LB-K 16 ZW.		70477200	1	16	79	90,4	87,8	64	96	29,5	40	50		57	3,5	36,5	4,5
H-A 16 SGR-LB-K 21 ZW.		70477400	1	21	79	90,4	87,8	64	96	29,5	40	50		57	3,5	36,5	4,5

A

C

L

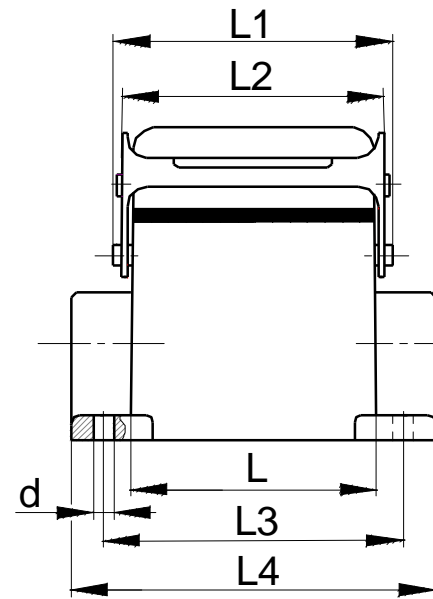
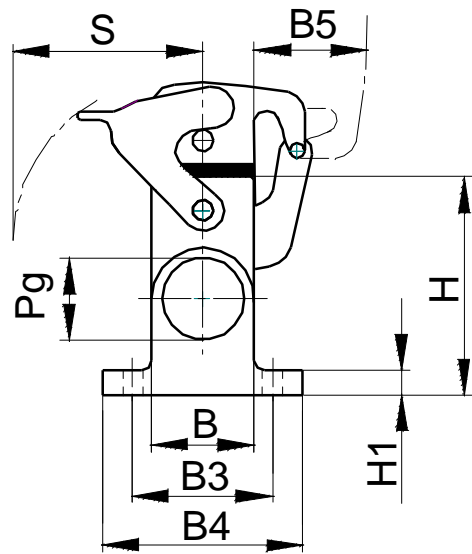

1997 27.10. Suchy

Socketgehäuse
mit LB und Deckel
KAG-0180-00

01

A

C

L

Benennung Description Désignation	Art. Nr. part No. N° art.	Art. Nr. part No. N° art.	Kabel Eingang Cable entry sortie	PG	L	L1	L2	L3	L4	B	B3	B4	B5	H	H1	S	d
H-A 10 SDRL-LB 16 ZW.	70456200		2	16	63	74,4	71,4	48	80	29,5	40	50	25	57	3,5	36,5	4,5
H-A 10 SDRL-LB 21 ZW.	70456400		2	21	63	74,4	71,4	48	80	29,5	40	50	25	57	3,5	36,5	4,5
H-A 10 SDRL-LB-K 16 ZW.		70458200	2	16	63	74,4	71,4	48	80	29,5	40	50	25	57	3,5	36,5	4,5
H-A 10 SDRL-LB-K 21 ZW.		70458400	2	21	63	74,4	71,4	48	80	29,5	40	50	25	57	3,5	36,5	4,5
H-A 10 SDR-LB 16 ZW.	70455200		1	16	63	74,4	71,4	48	80	29,5	40	50	25	57	3,5	36,5	4,5
H-A 10 SDR-LB 21 ZW.	70455400		1	21	63	74,4	71,4	48	80	29,5	40	50	25	57	3,5	36,5	4,5
H-A 10 SDR-LB-K 16 ZW.		70457200	1	16	63	74,4	71,4	48	80	29,5	40	50	25	57	3,5	36,5	4,5
H-A 10 SDR-LB-K 21 ZW.		70457400	1	21	63	74,4	71,4	48	80	29,5	40	50	25	57	3,5	36,5	4,5
H-A 16 SDRL-LB 16 ZW.	70486200		2	16	79	90,4	87,8	64	96	29,5	40	50	25	57	3,5	36,5	4,5
H-A 16 SDRL-LB 21 ZW.	70486400		2	21	79	90,4	87,8	64	96	29,5	40	50	25	57	3,5	36,5	4,5
H-A 16 SDRL-LB-K 16 ZW.		70488200	2	16	79	90,4	87,8	64	96	29,5	40	50	25	57	3,5	36,5	4,5
H-A 16 SDRL-LB-K 21 ZW.		70488400	2	21	79	90,4	87,8	64	96	29,5	40	50	25	57	3,5	36,5	4,5
H-A 16 SDR-LB 16 ZW.	70485200		1	16	79	90,4	87,8	64	96	29,5	40	50	25	57	3,5	36,5	4,5
H-A 16 SDR-LB 21 ZW.	70485400		1	21	79	90,4	87,8	64	96	29,5	40	50	25	57	3,5	36,5	4,5
H-A 16 SDR-LB-K 16 ZW.		70487200	1	16	79	90,4	87,8	64	96	29,5	40	50	25	57	3,5	36,5	4,5
H-A 16 SDR-LB-K 21 ZW.		70487400	1	21	79	90,4	87,8	64	96	29,5	40	50	25	57	3,5	36,5	4,5

A

C

L

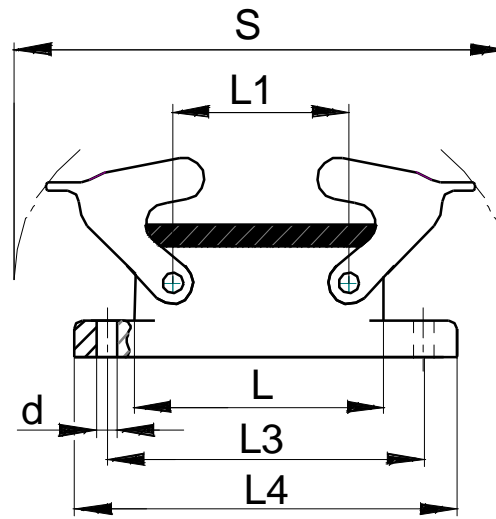
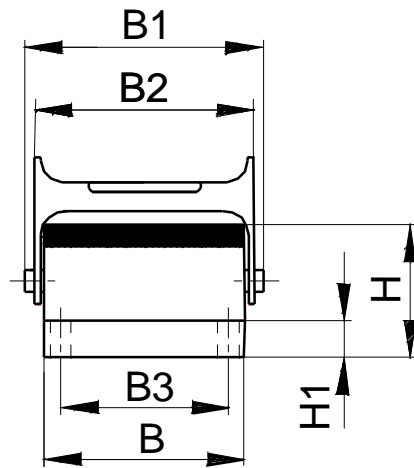

1997
28.10. Suchy

Anbaugehäuse
mit QB

KBG-0190-00

01 - - - -

A

C

L

Benennung	Art. Nr.	Art. Nr.	L	L1	L3	L4	B	B1	B2	B3	H	H1	S	d
Description	part No.	part No.												
Désignation	N° art.	N° art.												
H-A 32 AG	10472000		82	49,6	92	102	56	70,8	66	42	25,4	4	124,5	4,3
H-A 32 AG-K		70502500	82	49,6	92	102	56	70,8	66	42	25,4	4	124,5	4,3
H-A 48 AG	10625500		93,5	64,5	110	124	79	91	87,8	65	30,3	5	136,5	5,5

A

C

L

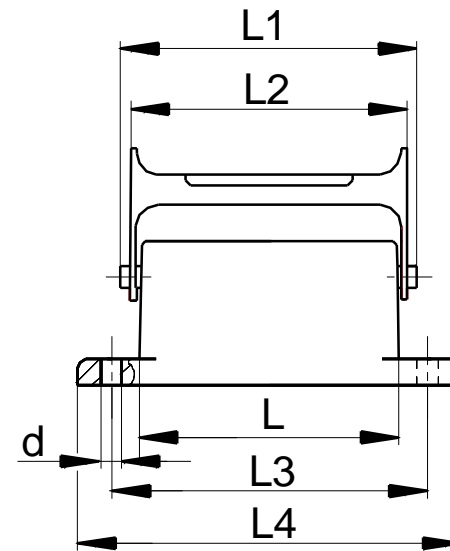
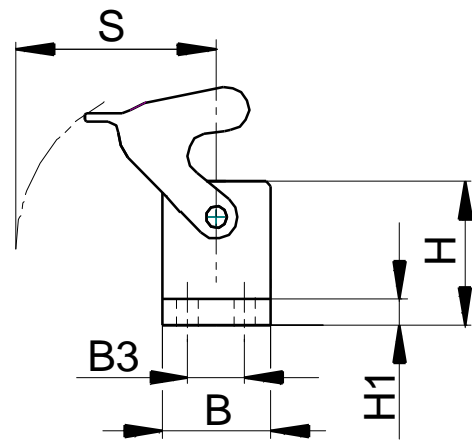

1997
27.10. Suchy

Anbaugehäuse
mit LB

KAG-0200-00

01

A

C

L

Benennung	Art. Nr.	Art. Nr.	L	L1	L2	L3	L4	B	B3	H	H1	S	d
Description	part No.	part No.											
Désignation	N° art.	N° art.											
H-A 10 AG-LB	10442000		63	74,4	71,4	70	81	29,5	17,5	25	3,5	36,5	3,6
H-A 10 AG-LB-K		70442500	63	74,4	71,4	70	81	29,5	17,5	25	3,5	36,5	3,6
H-A 16 AG-LB	10462000		79	90,4	87,8	86	96	29,5	17,5	25	3,5	36,5	3,6
H-A 16 AG-LB-K		70472500	79	90,4	87,8	86	96	29,5	17,5	25	3,5	36,5	3,6

A

C

L

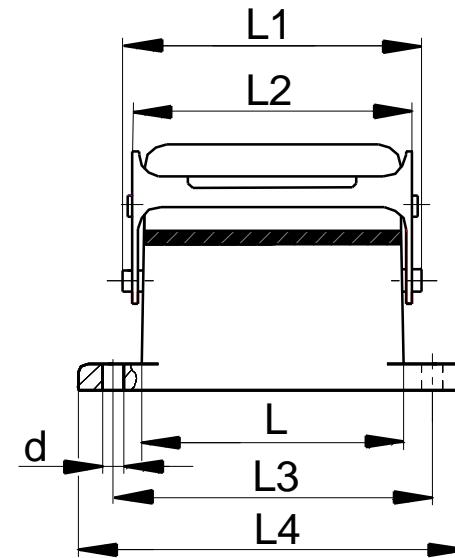
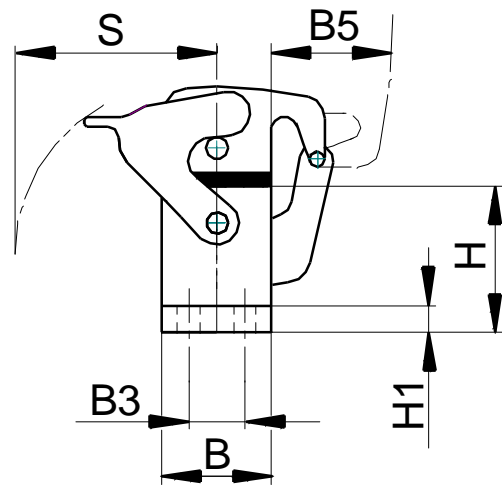

1997
27.10. Suchy

Anbaugehäuse
mit LB und Deckel
KAG-0210-00

01 --

A

C

L

Benennung	Art. Nr.	Art. Nr.	L	L1	L2	L3	L4	B	B3	B5	H	H1	S	d
Description	part No.	part No.												
Désignation	N° art.	N° art.												
H-A 10 AD-LB	70444000		63	74,4	71,4	70	81	29,5	17,5	25	25	3,5	36,5	3,6
H-A 10 AD-LB-K		70444500	63	74,4	71,4	70	81	29,5	17,5	25	25	3,5	36,5	3,6
H-A 16 AD-LB	70474000		79	90,4	87,8	86	96	29,5	17,5	25	25	3,5	36,5	3,6
H-A 16 AD-LB-K		70474500	79	90,4	87,8	86	96	29,5	17,5	25	25	3,5	36,5	3,6

A

C

L

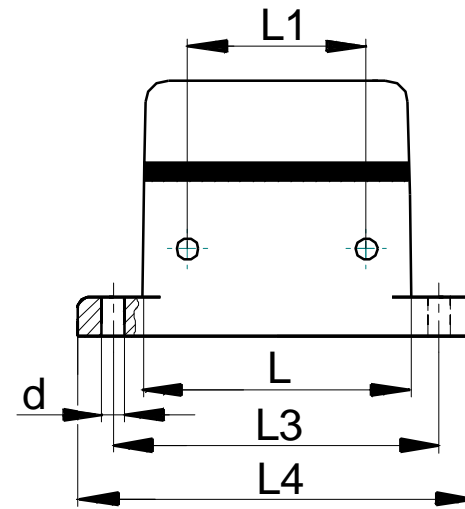
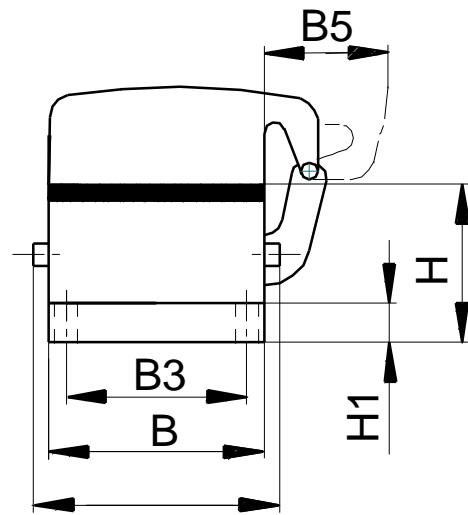

1997
07.11. Suchy

Anbaugehäuse
mit Deckel

KBG-0220-00

01 - - - -

A

C

L

Benennung	Art. Nr.	Art. Nr.	L	L1	L3	L4	B	B3	B5	H	H1	d
Description	part No.	part No.										
Désignation	N° art.	N° art.										
H-A 32 AD-BO	70503000		82	49,6	92	102	56	42	29	25,4	4	4,3
H-A 32 AD-BO-K		70503500	82	49,6	92	102	56	42	29	25,4	4	4,3

A

C

L

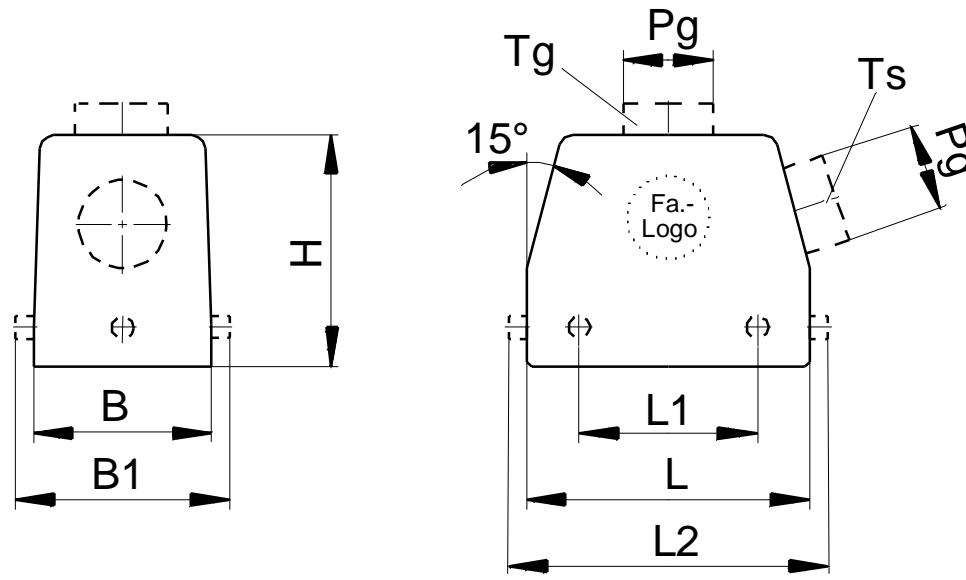

1997
07.11. Suchy

Tüllengehäuse nieder

KBG-0010-00

01 -----

A

C

L

Benennung Description Désignation	Art. Nr. part No. N° art.	Art. Nr. part No. N° art.	Kabel Eingang Cable entry sortie	PG	L	L1	L2	B	B1	H
H-B 6 TS 13,5 ZW	10012000		seitlich, side, latérale	13,5	60		74,8	43		52
H-B 6 TS 16 ZW.	10022000		seitlich, side, latérale	16	60		74,8	43		52
H-B 6 TS-K 13,5 ZW		70023600	seitlich, side, latérale	13,5	60		74,8	43		52
H-B 6 TS-K 16 ZW.		70023000	seitlich, side, latérale	16	60		74,8	43		52
H-B 6 TG 13,5 ZW	10011000		gerade, top, verticale	13,5	60		74,8	43		52
H-B 6 TG 16 ZW.	10021000		gerade, top, verticale	16	60		74,8	43		52
H-B 6 TG-K 13,5 ZW		70021600	gerade, top, verticale	13,5	60		74,8	43		52
H-B 6 TG-K 16 ZW.		70021000	gerade, top, verticale	16	60		74,8	43		52
H-B 10 TS-RO 16 ZW.	10042900		seitlich, side, latérale	16	73		90	43		52
H-B 10 TS-RO 21 ZW.	10042800		seitlich, side, latérale	21	73		90	43		52
H-B 10 TS-RO-K 16 ZW.		70059000	seitlich, side, latérale	16	73		90	43		52
H-B 10 TS-RO-K 21 ZW.		70059600	seitlich, side, latérale	21	73		90	43		52
H-B 10 TG-RO 16 ZW.	10040900		gerade, top, verticale	16	73		90	43		52
H-B 10 TG-RO 21 ZW.	10040700		gerade, top, verticale	21	73		90	43		52
H-B 10 TG-RO-K 16 ZW.		70049000	gerade, top, verticale	16	73		90	43		52
H-B 10 TG-RO-K 21 ZW.		70049600	gerade, top, verticale	21	73		90	43		52
H-B 10 TS 16 ZW.	10042000		seitlich, side, latérale	16	73	27		43	57,8	52
H-B 10 TS 21 ZW.	10042100		seitlich, side, latérale	21	73	27		43	57,8	52
H-B 10 TS-K 16 ZW.		70053000	seitlich, side, latérale	16	73	27		43	57,8	52
H-B 10 TS-K 21 ZW.		70053200	seitlich, side, latérale	21	73	27		43	57,8	52
H-B 10 TG 16 ZW.	10040000		gerade, top, verticale	16	73	27		43	57,8	52
H-B 10 TG 21 ZW.	10040100		gerade, top, verticale	21	73	27		43	57,8	52
H-B 10 TG-K 16 ZW.		70051000	gerade, top, verticale	16	73	27		43	57,8	52
H-B 10 TG-K 21 ZW.		70051200	gerade, top, verticale	21	73	27		43	57,8	52
H-B 16 TS-RO 21 ZW.	10082900		seitlich, side, latérale	21	93,3		110	43		61
H-B 16 TS-RO-K 21 ZW.		70109000	seitlich, side, latérale	21	93,3		110	43		61
H-B 16 TG-RO 21 ZW.	10080900		gerade, top, verticale	21	93,3		110	43		61
H-B 16 TG-RO-K 21 ZW.		70099000	gerade, top, verticale	21	93,3		110	43		61
H-B 16 TS 21 ZW.	10082000		seitlich, side, latérale	21	93,3	47,5		43	57,8	61
H-B 16 TS-K 21 ZW.		70103000	seitlich, side, latérale	21	93,3	47,5		43	57,8	61
H-B 16 TG 21 ZW.	10080000		gerade, top, verticale	21	93,3	47,5		43	57,8	61
H-B 16 TG-K 21 ZW.		70101000	gerade, top, verticale	21	93,3	47,5		43	57,8	61
H-B 24 TS-RO 21 ZW.	10113900		seitlich, side, latérale	21	120		137	43		61
H-B 24 TS-RO 29 ZW.	10123900		seitlich, side, latérale	29	120		137	43		61
H-B 24 TS-RO-K 21 ZW.		70159000	seitlich, side, latérale	21	120		137	43		61
H-B 24 TS-RO-K 29 ZW.		70159200	seitlich, side, latérale	29	120		137	43		61
H-B 24 TG-RO 21 ZW.	10121900		gerade, top, verticale	21	120		137	43		61
H-B 24 TG-RO 29 ZW.	10111900		gerade, top, verticale	29	120		137	43		61
H-B 24 TG-RO-K 21 ZW.		70149000	gerade, top, verticale	21	120		137	43		61
H-B 24 TG-RO-K 29 ZW.		70149200	gerade, top, verticale	29	120		137	43		61
H-B 24 TS 21 ZW.	10113000		seitlich, side, latérale	21	120	74		43	57,8	61
H-B 24 TS 29 ZW.	10123000		seitlich, side, latérale	29	120	74		43	57,8	61
H-B 24 TS-K 21 ZW.		70153000	seitlich, side, latérale	21	120	74		43	57,8	61
H-B 24 TS-K 29 ZW.		70153200	seitlich, side, latérale	29	120	74		43	57,8	61
H-B 24 TG 21 ZW.	10121000		gerade, top, verticale	21	120	74		43	57,8	61
H-B 24 TG 29 ZW.	10111000		gerade, top, verticale	29	120	74		43	57,8	61
H-B 24 TG-K 21 ZW.		70151000	gerade, top, verticale	21	120	74		43	57,8	61

A

C

L

Benennung	Art. Nr.	Art. Nr.	Kabel Eingang	PG	L	L1	L2	B	B1	H
Description	part No.	part No.	Cable entry							
Désignation	N° art.	N° art.	sortie							
H-B 24 TG-K 29 ZW.		70151200	gerade, top, verticale	29	120	74		43	57,8	61
H-B 48 TS 29 ZW.	10158000		seitlich, side, latérale	29	132		152	90		105
H-B 48 TS 36 ZW.	10159000		seitlich, side, latérale	36	132		152	90		105
H-B 48 TS 42 ZW.	10160000		seitlich, side, latérale	42	132		152	90		105
H-B 48 TG 29 ZW.	10155000		gerade, top, verticale	29	132		152	90		105
H-B 48 TG 36 ZW.	10156000		gerade, top, verticale	36	132		152	90		105
H-B 48 TG 42 ZW.	10157000		gerade, top, verticale	42	132		152	90		105

A

C

L

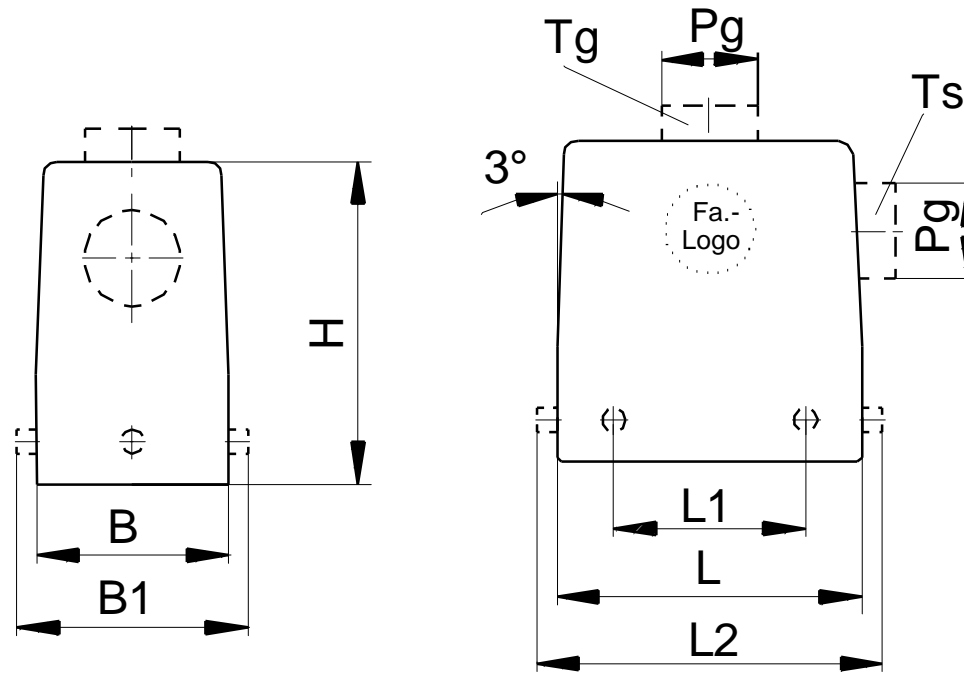

1997
28.10. Suchy

Tüllengehäuse

KBG-0020-00

01 -----

A

C

L

Benennung Description Désignation	Art. Nr. part No. N° art.	Art. Nr. part No. N° art.	Kabel Eingang Cable entry sortie	PG	L	L1	L2	B	B1	H
H-B 6 TSH 21 ZW.	70022200		seitlich, side, latérale	21	60		74,8	43		72
H-B 6 TSH 29 ZW.	70022400		seitlich, side, latérale	29	60		74,8	43		72
H-B 6 TSH-K 21 ZW.		70023200	seitlich, side, latérale	21	60		74,8	43		72
H-B 6 TSH-K 29 ZW.		70023400	seitlich, side, latérale	29	60		74,8	43		72
H-B 6 TGH 21 ZW.	70020200		gerade, top, verticale	21	60		74,8	43		72
H-B 6 TGH 29 ZW.	70020400		gerade, top, verticale	29	60		74,8	43		72
H-B 6 TGH-K 21 ZW.		70021200	gerade, top, verticale	21	60		74,8	43		72
H-B 6 TGH-K 29 ZW.		70021400	gerade, top, verticale	29	60		74,8	43		72
H-B 10 TSH-RO 21 ZW.	70054200		seitlich, side, latérale	21	73		90	43		72
H-B 10 TSH-RO 29 ZW.	70054400		seitlich, side, latérale	29	73		90	43		72
H-B 10 TSH-RO-K 21 ZW.		70059200	seitlich, side, latérale	21	73		90	43		72
H-B 10 TSH-RO-K 29 ZW.		70059400	seitlich, side, latérale	29	73		90	43		72
H-B 10 TGH-RO 21 ZW.	70044200		gerade, top, verticale	21	73		90	43		72
H-B 10 TGH-RO 29 ZW.	70044400		gerade, top, verticale	29	73		90	43		72
H-B 10 TGH-RO-K 21 ZW.		70049200	gerade, top, verticale	21	73		90	43		72
H-B 10 TGH-RO-K 29 ZW.		70049400	gerade, top, verticale	29	73		90	43		72
H-B 10 TSH 21 ZW.	70052400		seitlich, side, latérale	21	73	27		43	57,8	72
H-B 10 TSH 29 ZW.	70052600		seitlich, side, latérale	29	73	27		43	57,8	72
H-B 10 TSH-K 21 ZW.		70053400	seitlich, side, latérale	21	73	27		43	57,8	72
H-B 10 TSH-K 29 ZW.		70053600	seitlich, side, latérale	29	73	27		43	57,8	72
H-B 10 TGH 21 ZW.	70050400		gerade, top, verticale	21	73	27		43	57,8	72
H-B 10 TGH 29 ZW.	70050600		gerade, top, verticale	29	73	27		43	57,8	72
H-B 10 TGH-K 21 ZW.		70051400	gerade, top, verticale	21	73	27		43	57,8	72
H-B 10 TGH-K 29 ZW.		70051600	gerade, top, verticale	29	73	27		43	57,8	72
H-B 16 TSH-RO 21 ZW.	70104200		seitlich, side, latérale	21	93,3		110	43		76
H-B 16 TSH-RO 29 ZW.	70104400		seitlich, side, latérale	29	93,3		110	43		76
H-B 16 TSH-RO-K 21 ZW.		70109200	seitlich, side, latérale	21	93,3		110	43		76
H-B 16 TSH-RO-K 29 ZW.		70109400	seitlich, side, latérale	29	93,3		110	43		76
H-B 16 TGH-RO 21 ZW.	70094200		gerade, top, verticale	21	93,3		110	43		76
H-B 16 TGH-RO 29 ZW.	70094400		gerade, top, verticale	29	93,3		110	43		76
H-B 16 TGH-RO-K 21 ZW.		70099200	gerade, top, verticale	21	93,3		110	43		76
H-B 16 TGH-RO-K 29 ZW.		70099400	gerade, top, verticale	29	93,3		110	43		76
H-B 16 TSH 21 ZW.	70102200		seitlich, side, latérale	21	93,3	47,5		43	57,8	76
H-B 16 TSH 29 ZW.	70102400		seitlich, side, latérale	29	93,3	47,5		43	57,8	76
H-B 16 TSH-K 21 ZW.		70103200	seitlich, side, latérale	21	93,3	47,5		43	57,8	76
H-B 16 TSH-K 29 ZW.		70103400	seitlich, side, latérale	29	93,3	47,5		43	57,8	76
H-B 16 TGH 21 ZW.	70100200		gerade, top, verticale	21	93,3	47,5		43	57,8	76
H-B 16 TGH 29 ZW.	70100400		gerade, top, verticale	29	93,3	47,5		43	57,8	76
H-B 16 TGH-K 21 ZW.		70101200	gerade, top, verticale	21	93,3	47,5		43	57,8	76
H-B 16 TGH-K 29 ZW.		70101400	gerade, top, verticale	29	93,3	47,5		43	57,8	76
H-B 24 TSH-RO 21 ZW.	70154400		seitlich, side, latérale	21	120		137	43		76
H-B 24 TSH-RO 29 ZW.	70154600		seitlich, side, latérale	29	120		137	43		76
H-B 24 TSH-RO-K 21 ZW.		70159400	seitlich, side, latérale	21	120		137	43		76
H-B 24 TSH-RO-K 29 ZW.		70159600	seitlich, side, latérale	29	120		137	43		76
H-B 24 TGH-RO 21 ZW.	70144400		gerade, top, verticale	21	120		137	43		76
H-B 24 TGH-RO 29 ZW.	70144600		gerade, top, verticale	29	120		137	43		76
H-B 24 TGH-RO-K 21 ZW.		70149400	gerade, top, verticale	21	120		137	43		76

A

C

L

Benennung Description Désignation	Art. Nr. part No. N° art.	Art. Nr. part No. N° art.	Kabel Eingang Cable entry sortie	PG	L	L1	L2	B	B1	H
H-B 24 TGH-RO-K 29 ZW.		70149600	gerade, top, verticale	29	120		137	43		76
H-B 24 TSH 21 ZW.	70152400		seitlich, side, latérale	21	120	74		43	57,8	76
H-B 24 TSH 29 ZW.	70152600		seitlich, side, latérale	29	120	74		43	57,8	76
H-B 24 TSH-K 21 ZW.		70153400	seitlich, side, latérale	21	120	74		43	57,8	76
H-B 24 TSH-K 29 ZW.		70153600	seitlich, side, latérale	29	120	74		43	57,8	76
H-B 24 TGH 21 ZW.	70150400		gerade, top, verticale	21	120	74		43	57,8	76
H-B 24 TGH 29 ZW.	70150600		gerade, top, verticale	29	120	74		43	57,8	76
H-B 24 TGH-K 21 ZW.		70151400	gerade, top, verticale	21	120	74		43	57,8	76
H-B 24 TGH-K 29 ZW.		70151600	gerade, top, verticale	29	120	74		43	57,8	76
H-B 32 TS 29 ZW.	10136000		seitlich, side, latérale	29	93,5	64,5		79	89,5	95
H-B 32 TG 29 ZW.	10134000		gerade, top, verticale	29	93,5	64,5		79	89,5	95

A

C

L

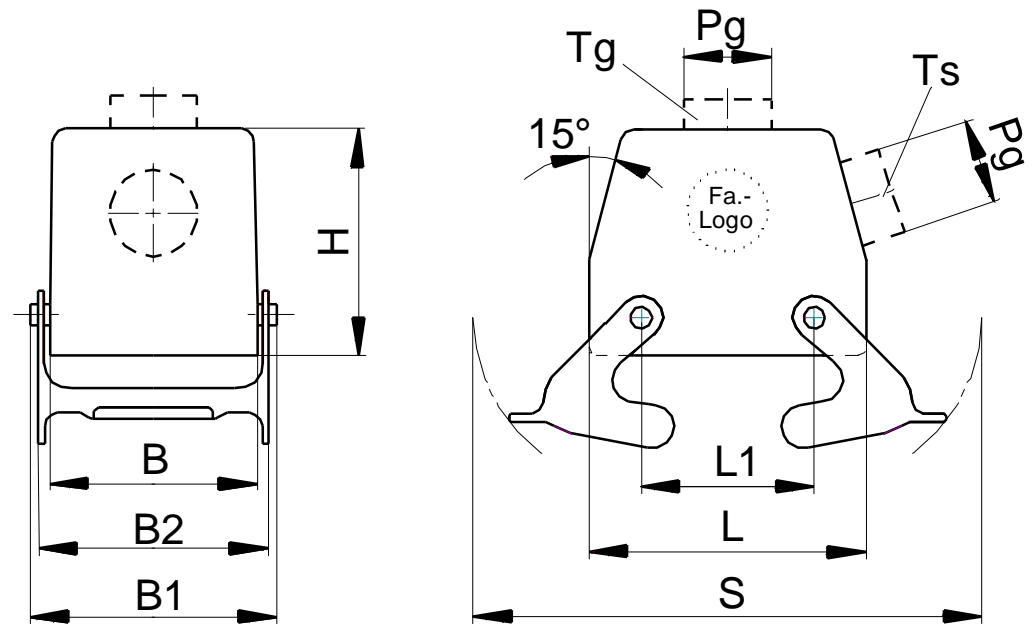

1997
07.11. Suchy

Tüllengehäuse mit QB

KBG-0030-00

01 -----

A

C

L

Benennung	Art. Nr.	Art. Nr.	Kabel Eingang	PG	L	L1	B	B1	B2	H	S
Description	part No.	part No.	Cable entry								
Désignation	N° art.	N° art.	sortie								
H-B 10 TSB 16 ZW.	10045000		seitlich, side, latérale	16	73	27	43	57,8	53	52	116
H-B 10 TSB-K 16 ZW.		70058000	seitlich, side, latérale	16	73	27	43	57,8	53	52	116
H-B 10 TGB 16 ZW.	10041000		gerade, top, verticale	16	73	27	43	57,8	53	52	116
H-B 10 TGB-K 16 ZW.		70056000	gerade, top, verticale	16	73	27	43	57,8	53	52	116
H-B 16 TSB 21 ZW.	10083000		seitlich, side, latérale	21	93,3	47,5	43	57,8	53	61	136,5
H-B 16 TSB-K 21 ZW.		70108000	seitlich, side, latérale	21	93,3	47,5	43	57,8	53	61	136,5
H-B 16 TGB 21 ZW.	10081000		gerade, top, verticale	21	93,3	47,5	43	57,8	53	61	136,5
H-B 16 TGB-K 21 ZW.		70106000	gerade, top, verticale	21	93,3	47,5	43	57,8	53	61	136,5
H-B 24 TSB 21 ZW.	10114000		seitlich, side, latérale	21	120	74	43	57,8	53	61	163
H-B 24 TSB 29 ZW.	10124000		seitlich, side, latérale	29	120	74	43	57,8	53	61	163
H-B 24 TSB-K 21 ZW.		70158000	seitlich, side, latérale	21	120	74	43	57,8	53	61	163
H-B 24 TSB-K 29 ZW.		70158200	seitlich, side, latérale	29	120	74	43	57,8	53	61	163
H-B 24 TGB 21 ZW.	10122000		gerade, top, verticale	21	120	74	43	57,8	53	61	163
H-B 24 TGB 29 ZW.	10112000		gerade, top, verticale	29	120	74	43	57,8	53	61	163
H-B 24 TGB-K 21 ZW.		70156000	gerade, top, verticale	21	120	74	43	57,8	53	61	163
H-B 24 TGB-K 29 ZW.		70156200	gerade, top, verticale	29	120	74	43	57,8	53	61	163

A

C

L

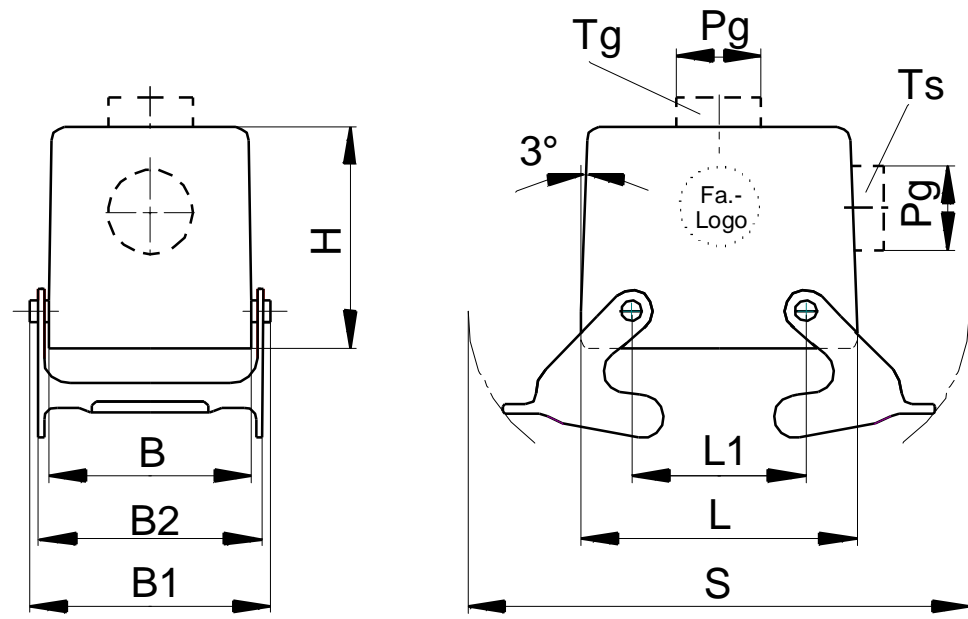

Tüllengehäuse
mit QB
KBG-0040-00

A

C

L

Benennung	Art. Nr.	Art. Nr.	Kabel Eingang	PG	L	L1	B	B1	B2	H	S
Description	part No.	part No.	Cable entry								
Désignation	N° art.	N° art.	sortie								
H-B 10 TSBH 21 ZW.	70057200		seitlich, side, latérale	21	73	27	43	57,8	53	72	116
H-B 10 TSBH 29 ZW.	70057400		seitlich, side, latérale	29	73	27	43	57,8	53	72	116
H-B 10 TSBH-K 21 ZW.		70058200	seitlich, side, latérale	21	73	27	43	57,8	53	72	116
H-B 10 TSBH-K 29 ZW.		70058400	seitlich, side, latérale	29	73	27	43	57,8	53	72	116
H-B 10 TGBH 21 ZW.	70055200		gerade, top, verticale	21	73	27	43	57,8	53	72	116
H-B 10 TGBH 29 ZW.	70055400		gerade, top, verticale	29	73	27	43	57,8	53	72	116
H-B 10 TGBH-K 21 ZW.		70056200	gerade, top, verticale	21	73	27	43	57,8	53	72	116
H-B 10 TGBH-K 29 ZW.		70056400	gerade, top, verticale	29	73	27	43	57,8	53	72	116
H-B 16 TSBH 21 ZW.	70107200		seitlich, side, latérale	21	93,3	47,5	43	57,8	53	76	136,5
H-B 16 TSBH 29 ZW.	70107400		seitlich, side, latérale	29	93,3	47,5	43	57,8	53	76	136,5
H-B 16 TSBH-K 21 ZW.		70108200	seitlich, side, latérale	21	93,3	47,5	43	57,8	53	76	136,5
H-B 16 TSBH-K 29 ZW.		70108400	seitlich, side, latérale	29	93,3	47,5	43	57,8	53	76	136,5
H-B 16 TGBH 21 ZW.	70105200		gerade, top, verticale	21	93,3	47,5	43	57,8	53	76	136,5
H-B 16 TGBH 29 ZW.	70105400		gerade, top, verticale	29	93,3	47,5	43	57,8	53	76	136,5
H-B 16 TGBH-K 21 ZW.		70106200	gerade, top, verticale	21	93,3	47,5	43	57,8	53	76	136,5
H-B 16 TGBH-K 29 ZW.		70106400	gerade, top, verticale	29	93,3	47,5	43	57,8	53	76	136,5
H-B 24 TSBH 21 ZW.	70157400		seitlich, side, latérale	21	120	74	43	57,8	53	76	163
H-B 24 TSBH 29 ZW.	70157600		seitlich, side, latérale	29	120	74	43	57,8	53	76	163
H-B 24 TSBH-K 21 ZW.		70158400	seitlich, side, latérale	21	120	74	43	57,8	53	76	163
H-B 24 TSBH-K 29 ZW.		70158600	seitlich, side, latérale	29	120	74	43	57,8	53	76	163
H-B 24 TGBH 21 ZW.	70155400		gerade, top, verticale	21	120	74	43	57,8	53	76	163
H-B 24 TGBH 29 ZW.	70155600		gerade, top, verticale	29	120	74	43	57,8	53	76	163
H-B 24 TGBH-K 21 ZW.		70156400	gerade, top, verticale	21	120	74	43	57,8	53	76	163
H-B 24 TGBH-K 29 ZW.		70156600	gerade, top, verticale	29	120	74	43	57,8	53	76	163
H-B 32 TSB 29	10136600		seitlich, side, latérale	29	93,5	64,5	79	91	87,8	95	136,5
H-B 32 TGB 29	70205000		gerade, top, verticale	29	93,5	64,5	79	91	87,8	95	136,5

A

C

L

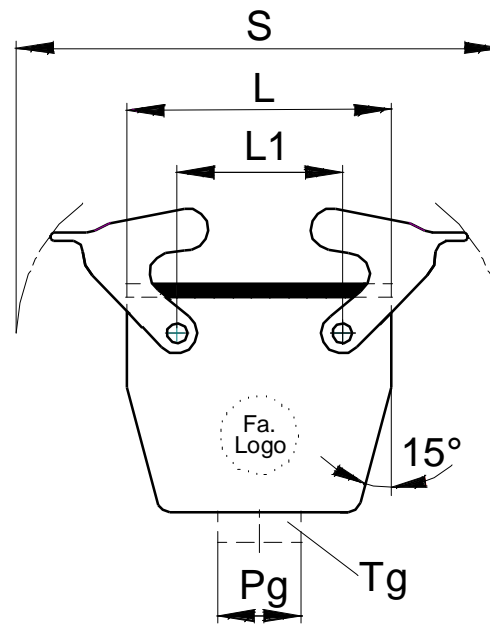
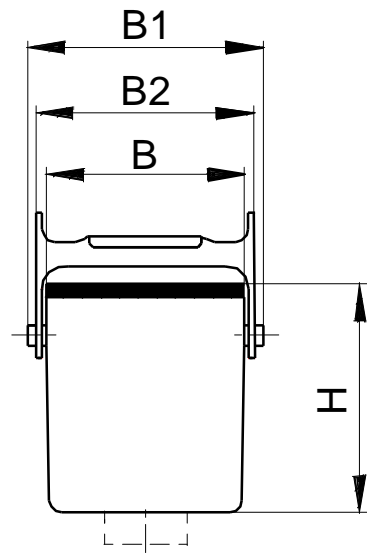

1997
07.11. Suchy

Kupplungsgehäuse
mit QB

KBG-0070-00

01 -----

A

C

L

Benennung	Art. Nr.	Art. Nr.	Kabel Eingang	PG	L	L1	B	B1	B2	H	S
Description	part No.	part No.	Cable entry								
Désignation	N° art.	N° art.	sortie								
H-B 10 TBF 16 ZW.	10046000		gerade, top, verticale	16	73	27	43	57,8	53	54,8	116
H-B 10 TBF 21 ZW.	70040200		gerade, top, verticale	21	73	27	43	57,8	53	54,8	116
H-B 10 TBF-K 16 ZW.		70041000	gerade, top, verticale	16	73	27	43	57,8	53	54,8	116
H-B 10 TBF-K 21 ZW.		70041200	gerade, top, verticale	21	73	27	43	57,8	53	54,8	116
H-B 16 TBF 21 ZW.	10086000		gerade, top, verticale	21	93,3	47,5	43	57,8	53	63,8	136,5
H-B 16 TBF-K 21 ZW.		70091000	gerade, top, verticale	21	93,3	47,5	43	57,8	53	63,8	136,5
H-B 24 TBF 21 ZW.	10127000		gerade, top, verticale	21	120	74	43	57,8	53	63,8	163
H-B 24 TBF 29 ZW.	10117000		gerade, top, verticale	29	120	74	43	57,8	53	63,8	163
H-B 24 TBF-K 21 ZW.		70141000	gerade, top, verticale	21	120	74	43	57,8	53	63,8	163
H-B 24 TBF-K 29 ZW.		70141200	gerade, top, verticale	29	120	74	43	57,8	53	63,8	163

A

C

L

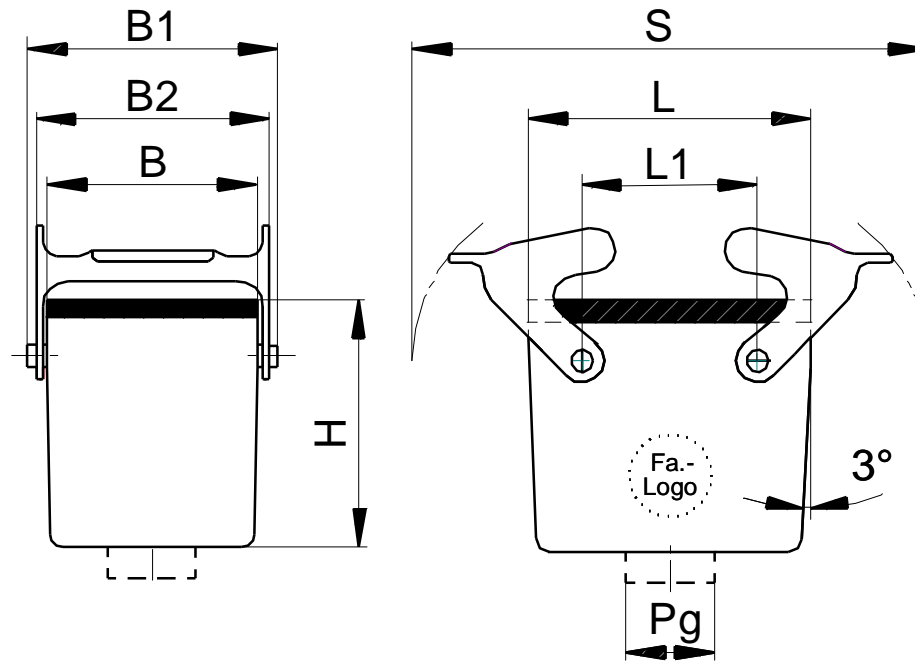

1997
07.11. Suchy

Kupplungsgehäuse
mit QB

KBG-0080-00

01 -----

A

C

L

Benennung	Art. Nr.	Art. Nr.	Kabel Eingang	PG	L	L1	B	B1	B2	H	S
Description	part No.	part No.	Cable entry								
Désignation	N° art.	N° art.	sortie								
H-B 10 TBFH 21 ZW.	70040400		gerade, top, verticale	21	73	27	43	57,8	53	74,8	116
H-B 10 TBFH 29 ZW.	70040600		gerade, top, verticale	29	73	27	43	57,8	53	74,8	116
H-B 10 TBFH-K 21 ZW.		70041400	gerade, top, verticale	21	73	27	43	57,8	53	74,8	116
H-B 10 TBFH-K 29 ZW.		70041600	gerade, top, verticale	29	73	27	43	57,8	53	74,8	116
H-B 16 TBFH 21 ZW.	70090200		gerade, top, verticale	21	93,3	47,5	43	57,8	53	78,8	136,5
H-B 16 TBFH 29 ZW.	70090400		gerade, top, verticale	29	93,3	47,5	43	57,8	53	78,8	136,5
H-B 16 TBFH-K 21 ZW.		70091200	gerade, top, verticale	21	93,3	47,5	43	57,8	53	78,8	136,5
H-B 16 TBFH-K 29 ZW.		70091400	gerade, top, verticale	29	93,3	47,5	43	57,8	53	78,8	136,5
H-B 24 TBFH 21 ZW.	70140400		gerade, top, verticale	21	120	74	43	57,8	53	78,8	163
H-B 24 TBFH 29 ZW.	70140600		gerade, top, verticale	29	120	74	43	57,8	53	78,8	163
H-B 24 TBFH-K 21 ZW.		70141400	gerade, top, verticale	21	120	74	43	57,8	53	78,8	163
H-B 24 TBFH-K 29 ZW.		70141600	gerade, top, verticale	29	120	74	43	57,8	53	78,8	163
H-B 32 TBFH 29	10139500		gerade, top, verticale	29	93,5	64,5	79	91	87,8	97	136,5

A

C

L

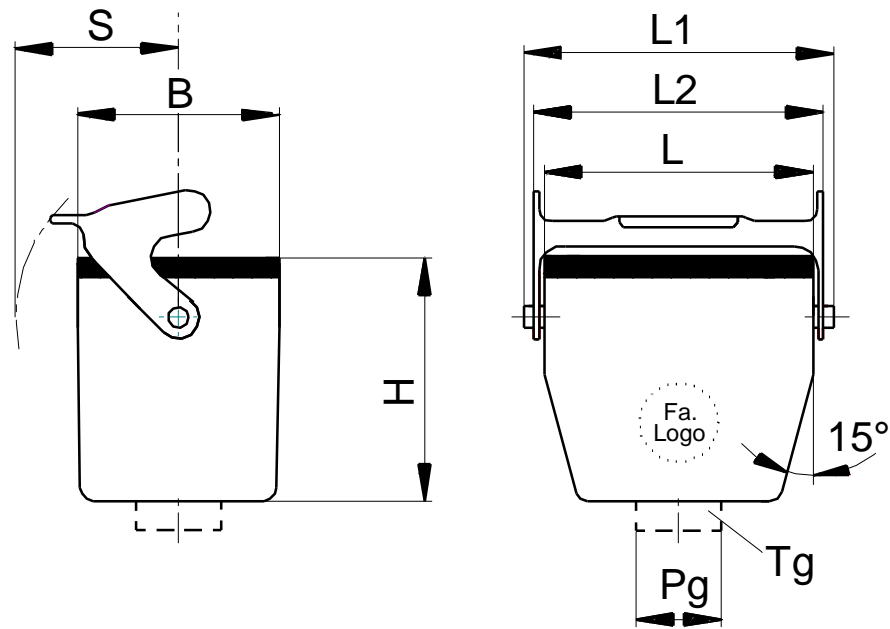

1997

07.11

Suchy

Kupplungsgehäuse
mit LB

KBG-0090-00

01 -----

A

C

L

Benennung	Art. Nr.	Art. Nr.	Kabel Eingang	PG	L	L1	L2	B	H	S
Description	part No.	part No.	Cable entry							
Désignation	N° art.	N° art.	sortie							
H-B 6 TBF 16 ZW.	10024000		gerade, top, verticale	16	60	74,8	70	43	54,8	44
H-B 6 TBF-K 16 ZW.		70011000	gerade, top, verticale	16	60	74,8	70	43	54,8	44
H-B 10 TBF-LB 16 ZW.	10046900		gerade, top, verticale	16	73	91	88,5	43	54,8	50
H-B 10 TBF-LB 21 ZW.	70042200		gerade, top, verticale	21	73	91	88,5	43	54,8	50
H-B 10 TBF-LB-K 16 ZW.		70043000	gerade, top, verticale	16	73	91	88,5	43	54,8	50
H-B 10 TBF-LB-K 21 ZW.		70043200	gerade, top, verticale	21	73	91	88,5	43	54,8	50
H-B 16 TBF-LB 21 ZW.	10086900		gerade, top, verticale	21	93,3	111	109,5	43	63,5	50
H-B 16 TBF-LB 21 ZW.		70093000	gerade, top, verticale	21	93,3	111	109,5	43	63,5	50
H-B 24 TBF-LB 21 ZW.	10127900		gerade, top, verticale	21	120	138	136,5	43	63,8	50
H-B 24 TBF-LB 29 ZW.	10117900		gerade, top, verticale	29	120	138	136,5	43	63,8	50
H-B 24 TBF-LB-K 21 ZW.		70143000	gerade, top, verticale	21	120	138	136,5	43	63,8	50
H-B 24 TBF-LB-K 29 ZW.		70143200	gerade, top, verticale	29	120	138	136,5	43	63,8	50

A

C

L

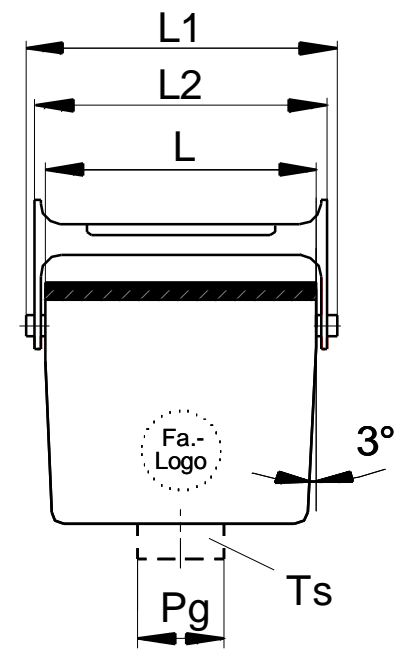
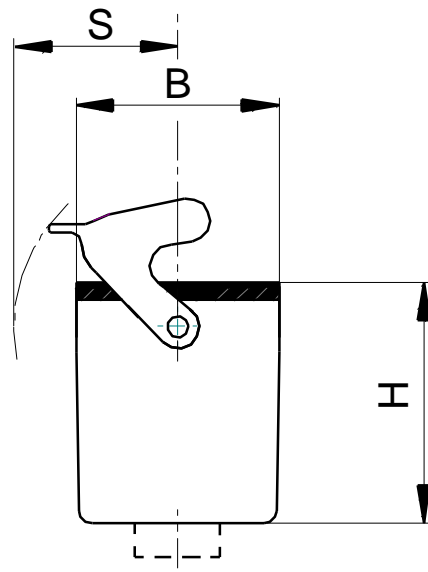

1997
07.11. Suchy

Kuplung mit LB

KBG-0100-00

01

A

C

L

Benennung Description Désignation	Art. Nr. part No. N° art.	Art. Nr. part No. N° art.	Kabel Eingang Cable entry sortie	PG	L	L1	L2	B	H	S
H-B 6 TBFH 21 ZW.	70010200		gerade, top, verticale	21	60	74,8	70	43	74,8	44
H-B 6 TBFH 29 ZW.	70010400		gerade, top, verticale	29	60	74,8	70	43	74,8	44
H-B 6 TBFH-K 21 ZW.		70011200	gerade, top, verticale	21	60	74,8	70	43	74,8	44
H-B 6 TBFH-K 29 ZW.		70011400	gerade, top, verticale	29	60	74,8	70	43	74,8	44
H-B 10 TBFH-LB 21 ZW.	70042400		gerade, top, verticale	21	73	91	88,5	43	74,8	50
H-B 10 TBFH-LB 29 ZW.	70042600		gerade, top, verticale	29	73	91	88,5	43	74,8	50
H-B 10 TBFH-LB-K 21 ZW.		70043400	gerade, top, verticale	21	73	91	88,5	43	74,8	50
H-B 10 TBFH-LB-K 29 ZW.		70043600	gerade, top, verticale	29	73	91	88,5	43	74,8	50
H-B 16 TBFH-LB 21 ZW.	70092200		gerade, top, verticale	21	93,3	111	109,5	43	78,8	50
H-B 16 TBFH-LB 29 ZW.	70092400		gerade, top, verticale	29	93,3	111	109,5	43	78,8	50
H-B 16 TBFH-LB-K 21 ZW.		70093200	gerade, top, verticale	21	93,3	111	109,5	43	78,8	50
H-B 16 TBFH-LB-K 29 ZW.		70093400	gerade, top, verticale	29	93,3	111	109,5	43	78,8	50
H-B 24 TBFH-LB 21 ZW.	70142400		gerade, top, verticale	21	120	138	136,5	43	78,8	50
H-B 24 TBFH-LB 29 ZW.	70142600		gerade, top, verticale	29	120	138	136,5	43	78,8	50
H-B 24 TBFH-LB-K 21 ZW.		70143400	gerade, top, verticale	21	120	138	136,5	43	78,8	50
H-B 24 TBFH-LB-K 29 ZW.		70143600	gerade, top, verticale	29	120	138	136,5	43	78,8	50

A

C

L

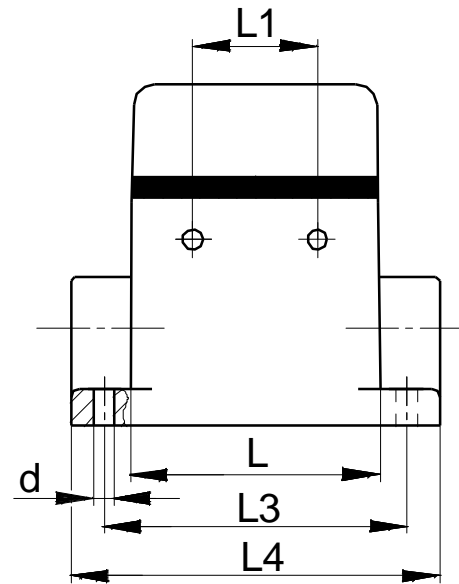
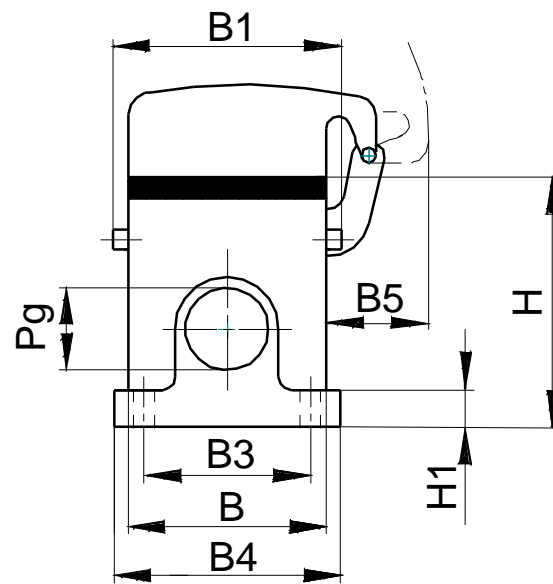

1997
07.11. Suchy

Sockelgehäuse
mit Deckel (ohne Bügel)

KBG-0120-00

01 -----

A

C

L

Benennung Description Désignation	Art. Nr. part No. N° art.	Art. Nr. part No. N° art.	Kabel Eingang Cable entry sortie	PG	L	L1	L3	L4	B	B1	B3	B4	B5	H	H1	d
H-B 10 SDRL-BO 16 ZW.	10038000		2	16	73	27	82	94	43	57,8	40	54	25	57	4,5	5,5
H-B 10 SDRL-BO-K 16 ZW.		70048000	2	16	73	27	82	94	43	57,8	40	54	25	57	4,5	5,5
H-B 10 SDR-BO 16 ZW.	10036000		1	16	73	27	82	94	43	57,8	40	54	25	57	4,5	5,5
H-B 10 SDR-BO-K 16 ZW.		70047000	1	16	73	27	82	94	43	57,8	40	54	25	57	4,5	5,5
H-B 10 SDRLH-BO 21 ZW.	70046200		2	21	73	27	82	97	43	57,8	45	58	25	74	6	5,5
H-B 10 SDRLH-BO 29 ZW.	70046400		2	29	73	27	82	97	43	57,8	45	58	25	74	6	5,5
H-B 10 SDRLH-BO-K 21 ZW.		70048200	2	21	73	27	82	97	43	57,8	45	58	25	74	6	5,5
H-B 10 SDRLH-BO-K 29 ZW.		70048400	2	29	73	27	82	97	43	57,8	45	58	25	74	6	5,5
H-B 10 SDRH-BO 21 ZW.	70045200		1	21	73	27	82	97	43	57,8	45	58	25	74	6	5,5
H-B 10 SDRH-BO 29 ZW.	70045400		1	29	73	27	82	97	43	57,8	45	58	25	74	6	5,5
H-B 10 SDRH-BO-K 21 ZW.		70047200	1	21	73	27	82	97	43	57,8	45	58	25	74	6	5,5
H-B 10 SDRH-BO-K 29 ZW.		70047400	1	29	73	27	82	97	43	57,8	45	58	25	74	6	5,5
H-B 16 SDRL-BO 21 ZW.	70096000		2	21	93	47,5	105	117	43		45	57	25	64	4,5	5,5
H-B 16 SDRL-BO-K 21 ZW.		70098000	2	21	93	47,5	105	117	43		45	57	25	64	4,5	5,5
H-B 16 SDR-BO 21 ZW.	10076000		1	21	93	47,5	105	117	43		45	57	25	64	4,5	5,5
H-B 16 SDR-BO-K 21 ZW.		70097000	1	21	93	47,5	105	117	43		45	57	25	64	4,5	5,5
H-B 16 SDRLH-BO 21 ZW.	70096200		2	21	93,3	47,5	105	117	43		45	58	25	84	6	5,5
H-B 16 SDRLH-BO 29 ZW.	70096400		2	29	93,3	47,5	105	117	43		45	58	25	84	6	5,5
H-B 16 SDRLH-BO-K 21 ZW.		70098200	2	21	93,3	47,5	105	117	43		45	58	25	84	6	5,5
H-B 16 SDRLH-BO-K 29 ZW.		70098400	2	29	93,3	47,5	105	117	43		45	58	25	84	6	5,5
H-B 16 SDRH-BO 21 ZW.	70095200		1	21	93,3	47,5	105	117	43		45	58	25	84	6	5,5
H-B 16 SDRH-BO 29 ZW.	70095400		1	29	93,3	47,5	105	117	43		45	58	25	84	6	5,5
H-B 16 SDRH-BO-K 21 ZW.		70097200	1	21	93,3	47,5	105	117	43		45	58	25	84	6	5,5
H-B 16 SDRH-BO-K 29 ZW.		70097400	1	29	93,3	47,5	105	117	43		45	58	25	84	6	5,5
H-B 24 SDRL-BO 21 ZW.	10109000		2	21	120	74	132	144	43	57,8	45	57	25	64	4,5	5,5
H-B 24 SDRL-BO-K 21 ZW.		70148000	2	21	120	74	132	144	43	57,8	45	57	25	64	4,5	5,5
H-B 24 SDR-BO 21 ZW.	10107000		1	21	120	74	132	144	43	57,8	45	57	25	64	4,5	5,5

A

C

L

Benennung	Art. Nr.	Art. Nr.	Kabel Eingang	PG	L	L1	L3	L4	B	B1	B3	B4	B5	H	H1	d
Description	part No.	part No.	Cable entry													
Désignation	N° art.	N° art.	sortie													
H-B 24 SDR-BO-K 21 ZW.		70147000	1	21	120	74	132	144	43	57,8	45	57	25	64	4,5	5,5
H-B 24 SDRLH-BO 21 ZW.	70146200		2	21	120	74	132	144	43	57,8	45	58	25	84	6	5,5
H-B 24 SDRLH-BO 29 ZW.	70146400		2	29	120	74	132	144	43	57,8	45	58	25	84	6	5,5
H-B 24 SDRLH-BO-K 21 ZW.		70148200	2	21	120	74	132	144	43	57,8	45	58	25	84	6	5,5
H-B 24 SDRLH-BO-K 29 ZW.		70148400	2	29	120	74	132	144	43	57,8	45	58	25	84	6	5,5
H-B 24 SDRH-BO 21 ZW.	70145200		1	21	120	74	132	144	43	57,8	45	58	25	84	6	5,5
H-B 24 SDRH-BO 29 ZW.	70145400		1	29	120	74	132	144	43	57,8	45	58	25	84	6	5,5
H-B 24 SDRH-BO-K 21 ZW.		70147200	1	21	120	74	132	144	43	57,8	45	58	25	84	6	5,5
H-B 24 SDRH-BO-K 29 ZW.		70147400	1	29	120	74	132	144	43	57,8	45	58	25	84	6	5,5

A

C

L

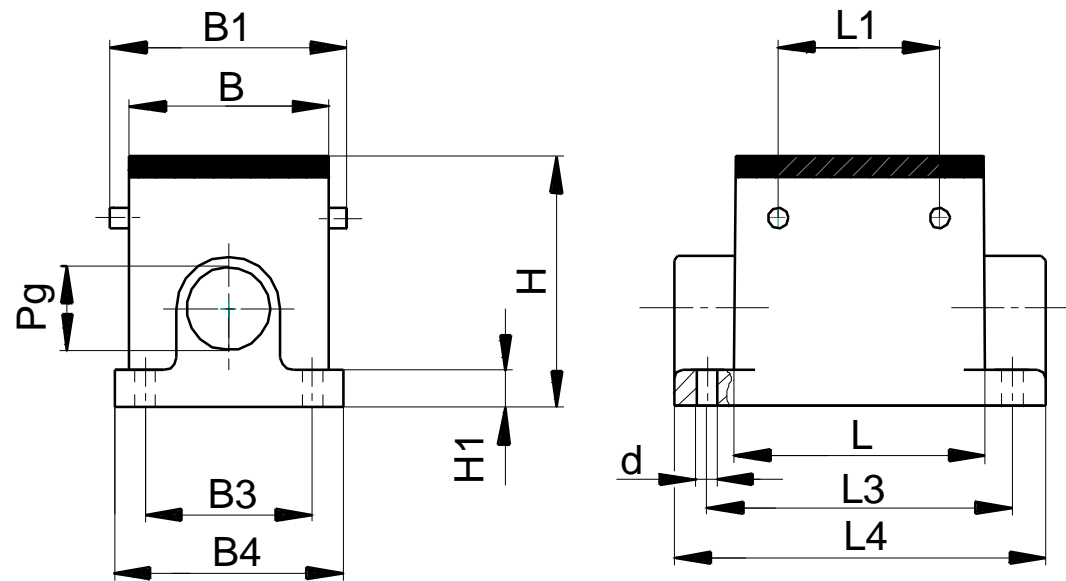

1997
28.10. Suchy

Sockelgehäuse
(ohne Deckel und ohne Bügel)

KBG-0125-00

01 - - - -

A

C

L

Benennung	Art. Nr.	Art. Nr.	Kabel Eingang												
Description	part No.	part No.	Cable entry	PG	L	L1	L3	L4	B	B1	B3	B4	H	H1	d
Désignation	N° art.	N° art.	sortie												
H-B 32 SGRL-BO 29 ZW.	10138300		2	29	93,5	64,5	112	124,5	79	89,5	67	81	72	5	5,5
H-B 32 SGR-BO 29 ZW.	10137300		1	29	93,5	64,5	112	124,5	79	89,5	67	81	72	5	5,5

A

C

L

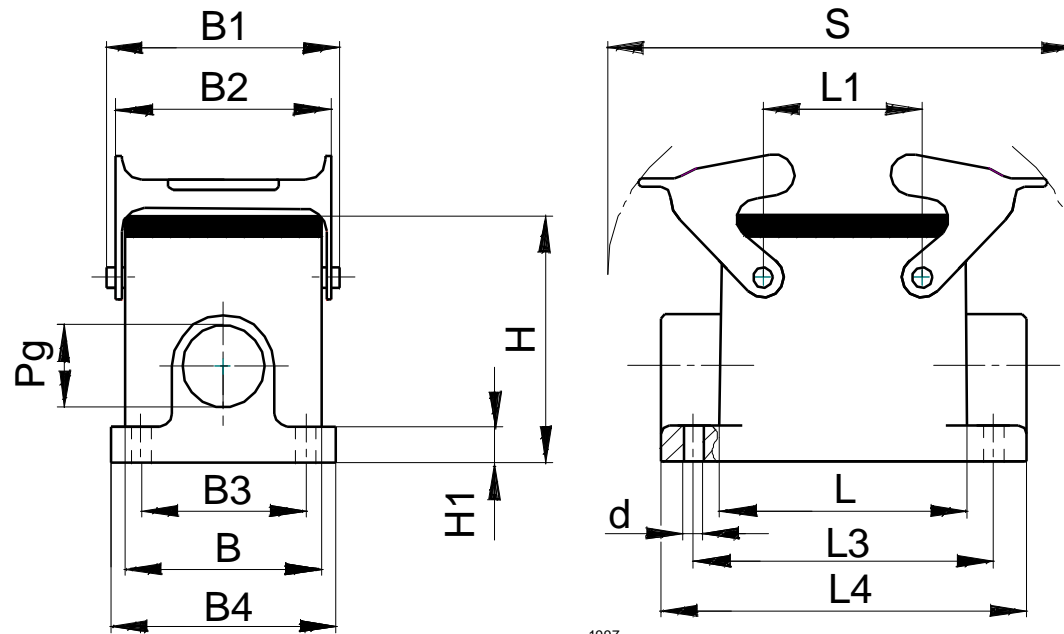

1997
28.10. Suchy

Sockelgehäuse
mit QB (ohne Deckel)

KBG-0140-00

01

A

C

L

Benennung Description Désignation	Art. Nr. part No. N° art.	Art. Nr. part No. N° art.	Kabel Eingang Cable entry sortie	PG	L	L1	L3	L4	B	B1	B2	B3	B4	H	H1	S	d
H-B 10 SGRL 16 ZW.	10035000		2	16	73	27	82	94	43	57,8	53	40	54	57	4,5	116	5,5
H-B 10 SGRL-K 16 ZW.		70038000	2	16	73	27	82	94	43	57,8	53	40	54	57	4,5	116	5,5
H-B 10 SGR 16 ZW.	10034000		1	16	73	27	82	94	43	57,8	53	40	54	57	4,5	116	5,5
H-B 10 SGR-K 16 ZW.		70037000	1	16	73	27	82	94	43	57,8	53	40	54	57	4,5	116	5,5
H-B 10 SGRLH 21 ZW.	70036200		2	21	73	27	82	97	43	57,8	53	45	58	74	6	116	5,5
H-B 10 SGRLH 29 ZW.	70036400		2	29	73	27	82	97	43	57,8	53	45	58	74	6	116	5,5
H-B 10 SGRLH-K 21 ZW.		70038200	2	21	73	27	82	97	43	57,8	53	45	58	74	6	116	5,5
H-B 10 SGRLH-K 29 ZW.		70038400	2	29	73	27	82	97	43	57,8	53	45	58	74	6	116	5,5
H-B 10 SGRH 21 ZW.	70035200		1	21	73	27	82	97	43	57,8	53	45	58	74	6	116	5,5
H-B 10 SGRH 29 ZW.	70035400		1	29	73	27	82	97	43	57,8	53	45	58	74	6	116	5,5
H-B 10 SGRH-K 21 ZW.		70037200	1	21	73	27	82	97	43	57,8	53	45	58	74	6	116	5,5
H-B 10 SGRH-K 29 ZW.		70037400	1	29	73	27	82	97	43	57,8	53	45	58	74	6	116	5,5
H-B 16 SGRL 21 ZW.	10075000		2	21	93	47,5	105	117	43	57,8	53	45	57	64	4,5	136,5	5,5
H-B 16 SGRL-K 21 ZW.		70088000	2	21	93	47,5	105	117	43	57,8	53	45	57	64	4,5	136,5	5,5
H-B 16 SGR 21 ZW.	10074000		1	21	93	47,5	105	117	43	57,8	53	45	57	64	4,5	136,5	5,5
H-B 16 SGR-K 21 ZW.		70087000	1	21	93	47,5	105	117	43	57,8	53	45	57	64	4,5	136,5	5,5
H-B 16 SGRLH 21 ZW.	70086200		2	21	93,3	47,5	105	117	43	57,8	53	45	58	84	6	136,5	5,5
H-B 16 SGRLH 29 ZW.	70086400		2	29	93,3	47,5	105	117	43	57,8	53	45	58	84	6	136,5	5,5
H-B 16 SGRLH-K 21 ZW.		70088200	2	21	93,3	47,5	105	117	43	57,8	53	45	58	84	6	136,5	5,5
H-B 16 SGRLH-K 29 ZW.		70088400	2	29	93,3	47,5	105	117	43	57,8	53	45	58	84	6	136,5	5,5
H-B 16 SGRH 21 ZW.	70085200		1	21	93,3	47,5	105	117	43	57,8	53	45	58	84	6	136,5	5,5
H-B 16 SGRH 29 ZW.	70085400		1	29	93,3	47,5	105	117	43	57,8	53	45	58	84	6	136,5	5,5
H-B 16 SGRH-K 21 ZW.		70087200	1	21	93,3	47,5	105	117	43	57,8	53	45	58	84	6	136,5	5,5
H-B 16 SGRH-K 29 ZW.		70087400	1	29	93,3	47,5	105	117	43	57,8	53	45	58	84	6	136,5	5,5
H-B 24 SGRL 16 ZW.	10105000		2	21	120	74	132	144	43	57,8	53	45	57	64	4,5	163	5,5
H-B 24 SGRL-K 16 ZW.		70138000	2	21	120	74	132	144	43	57,8	53	45	57	64	4,5	163	5,5
H-B 24 SGR 16 ZW.	10104000		1	21	120	74	132	144	43	57,8	53	45	57	64	4,5	163	5,5

A

C

L

Benennung Description Désignation	Art. Nr. part No. N° art.	Art. Nr. part No. N° art.	Kabel Eingang Cable entry sortie	PG	L	L1	L3	L4	B	B1	B2	B3	B4	H	H1	S	d
H-B 24 SGR-K 16 ZW.		70137000	1	21	120	74	132	144	43	57,8	53	45	57	64	4,5	163	5,5
H-B 24 SGRLH 21 ZW.	70136200		2	21	120	74	132	144	43	57,8	53	45	58	84	6	163	5,5
H-B 24 SGRLH-K 29 ZW.	70136400		2	29	120	74	132	144	43	57,8	53	45	58	84	6	163	5,5
H-B 24 SGRLH 21 ZW.		70138200	2	21	120	74	132	144	43	57,8	53	45	58	84	6	163	5,5
H-B 24 SGRLH-K 29 ZW.		70138400	2	29	120	74	132	144	43	57,8	53	45	58	84	6	163	5,5
H-B 24 SGRH 21 ZW.	70135200		1	21	120	74	132	144	43	57,8	53	45	58	84	6	163	5,5
H-B 24 SGRH-K 29 ZW.	70135400		1	29	120	74	132	144	43	57,8	53	45	58	84	6	163	5,5
H-B 24 SGRLH 21 ZW.		70137200	1	21	120	74	132	144	43	57,8	53	45	58	84	6	163	5,5
H-B 24 SGRLH-K 29 ZW.		70137400	1	29	120	74	132	144	43	57,8	53	45	58	84	6	163	5,5
H-B 32 SGRL 29 ZW.	10138000		2	29	93,5	64,5	112	124,5	79	91	87,8	67	81	72	5	136,5	5,5
H-B 32 SGR 29 ZW.	10137000		1	29	93,5	64,5	112	124,5	79	91	87,8	67	81	72	5	136,5	5,5

A

C

L

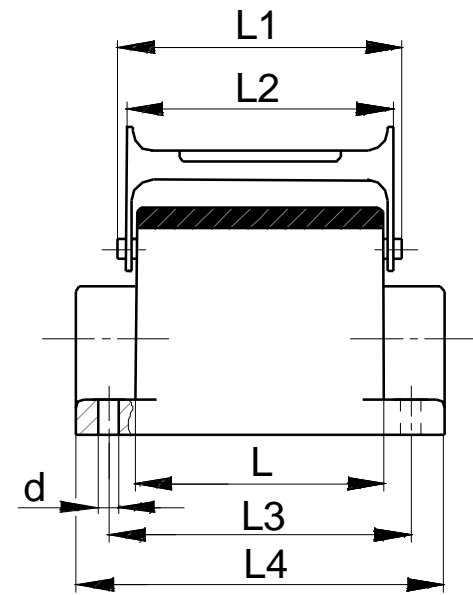
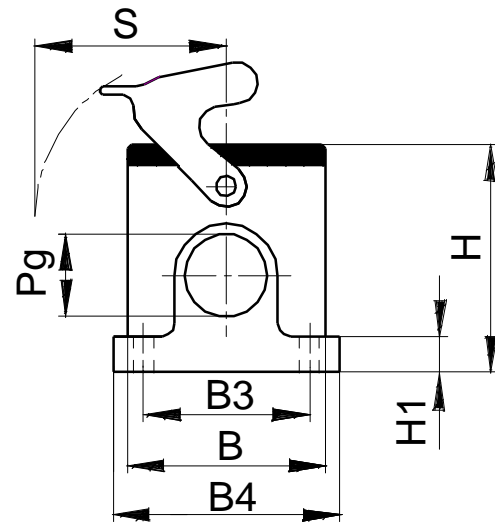

1997 07.11. Suchy

Socketgehäuse
mit LB

KBG-0160-00

01 -----

A

C

L

Benennung Description Désignation	Art. Nr. part No. N° art.	Art. Nr. part No. N° art.	Kabel Eingang Cable entry sortie	PG	L	L1	L2	L3	L4	B	B3	B4	H	H1	S	d
H-B 6 SGRL 16 ZW.	10006000		2	16	60	74,8	70	70	84	43	40	54	54	4,5	44	5,5
H-B 6 SGRL-K 16 ZW.		70008000	2	16	60	74,8	70	70	84	43	40	54	54	4,5	44	5,5
H-B 6 SGR 16 ZW.	10005000		1	16	60	74,8	70	70	84	43	40	54	54	4,5	44	5,5
H-B 6 SGR-K 16 ZW.		70007000	1	16	60	74,8	70	70	84	43	40	54	54	4,5	44	5,5
H-B 6 SGR LH 21 ZW.	70006200		2	21	60	74,8	70	70	84	43	45	58	74	6	44	5,5
H-B 6 SGR LH 29 ZW.	70006400		2	29	60	74,8	70	70	84	43	45	58	74	6	44	5,5
H-B 6 SGR LH-K 21 ZW.		70008200	2	21	60	74,8	70	70	84	43	45	58	74	6	44	5,5
H-B 6 SGR LH-K 29 ZW.		70008400	2	29	60	74,8	70	70	84	43	45	58	74	6	44	5,5
H-B 6 SGR H 21 ZW.	70005200		1	21	60	74,8	70	70	84	43	45	58	74	6	44	5,5
H-B 6 SGR H 29 ZW.	70005400		1	29	60	74,8	70	70	84	43	45	58	74	6	44	5,5
H-B 6 SGR H-K 21 ZW.		70007200	1	21	60	74,8	70	70	84	43	45	58	74	6	44	5,5
H-B 6 SGR H-K 29 ZW.		70007400	1	29	60	74,8	70	70	84	43	45	58	74	6	44	5,5
H-B 10 SGRL-LB 16 ZW.	10035900		2	16	73	91	88,5	82	94	43	40	54	57	4,5	50	5,5
H-B 10 SGRL-LB-K 16 ZW.		70063000	2	16	73	91	88,5	82	94	43	40	54	57	4,5	50	5,5
H-B 10 SGR-LB 16 ZW.	10034900		1	16	73	91	88,5	82	94	43	40	54	57	4,5	50	5,5
H-B 10 SGR-LB-K 16 ZW.		70062000	1	16	73	91	88,5	82	94	43	40	54	57	4,5	50	5,5
H-B 10 SGR LH-LB 21 ZW.	70061200		2	21	73	91	88,5	82	97	43	45	58	74	6	50	5,5
H-B 10 SGR LH-LB 29 ZW.	70061400		2	29	73	91	88,5	82	97	43	45	58	74	6	50	5,5
H-B 10 SGR LH-LB-K 21 ZW.		70063200	2	21	73	91	88,5	82	97	43	45	58	74	6	50	5,5
H-B 10 SGR LH-LB-K 29 ZW.		70063400	2	29	73	91	88,5	82	97	43	45	58	74	6	50	5,5
H-B 10 SGR H-LB 21 ZW.	70060200		1	21	73	91	88,5	82	97	43	45	58	74	6	50	5,5
H-B 10 SGR H-LB 29 ZW.	70060400		1	29	73	91	88,5	82	97	43	45	58	74	6	50	5,5
H-B 10 SGR H-LB-K 21 ZW.		70062200	1	21	73	91	88,5	82	97	43	45	58	74	6	50	5,5
H-B 10 SGR H-LB-K 29 ZW.		70062400	1	29	73	91	88,5	82	97	43	45	58	74	6	50	5,5
H-B 16 SGRL-LB 21 ZW.	10075900		2	21	93	111	109,5	105	117	43	45	57	64	4,5	50	5,5
H-B 16 SGRL-LB-K 21 ZW.		70113000	2	21	93	111	109,5	105	117	43	45	57	64	4,5	50	5,5
H-B 16 SGR-LB 21 ZW.	10074900		1	21	93	111	109,5	105	117	43	45	57	64	4,5	50	5,5

A

C

L

Benennung Description Désignation	Art. Nr. part No. N° art.	Art. Nr. part No. N° art.	Kabel Eingang Cable entry sortie	PG	L	L1	L2	L3	L4	B	B3	B4	H	H1	S	d
H-B 16 SGR-LB-K 21 ZW.		70112000	1	21	93	111	109,5	105	117	43	45	57	64	4,5	50	5,5
H-B 16 SGRLH-LB 21 ZW.	70111200		2	21	93,3	111	109,5	105	117	43	45	58	84	6	50	5,5
H-B 16 SGRLH-LB 29 ZW.	70111400		2	29	93,3	111	109,5	105	117	43	45	58	84	6	50	5,5
H-B 16 SGRLH-LB-K 21 ZW.		70113200	2	21	93,3	111	109,5	105	117	43	45	58	84	6	50	5,5
H-B 16 SGRLH-LB-K 29 ZW.		70113400	2	29	93,3	111	109,5	105	117	43	45	58	84	6	50	5,5
H-B 16 SGRH-LB 21 ZW.	70110200		1	21	93,3	111	109,5	105	117	43	45	58	84	6	50	5,5
H-B 16 SGRH-LB 29 ZW.	70110400		1	29	93,3	111	109,5	105	117	43	45	58	84	6	50	5,5
H-B 16 SGRH-LB-K 21 ZW.		70112200	1	21	93,3	111	109,5	105	117	43	45	58	84	6	50	5,5
H-B 16 SGRH-LB-K 29 ZW.		70112400	1	29	93,3	111	109,5	105	117	43	45	58	84	6	50	5,5
H-B 24 SGRL-LB 21 ZW.	10105900		2	21	120	138	136,5	132	144	43	45	57	64	4,5	50	5,5
H-B 24 SGRL-LB-K 21 ZW.		70163000	2	21	120	138	136,5	132	144	43	45	57	64	4,5	50	5,5
H-B 24 SGR-LB 16 ZW.	10104900		1	21	120	138	136,5	132	144	43	45	57	64	4,5	50	5,5
H-B 24 SGR-LB-K 16 ZW.		70162000	1	21	120	138	136,5	132	144	43	45	57	64	4,5	50	5,5
H-B 24 SGRLH-LB 21 ZW.	70161200		2	21	120	138	136,5	132	144	43	45	57,8	84	6	50	5,5
H-B 24 SGRLH-LB 29 ZW.	70161400		2	29	120	138	136,5	132	144	43	45	57,8	84	6	50	5,5
H-B 24 SGRLH-LB-K 21 ZW.		70163200	2	21	120	138	136,5	132	144	43	45	57,8	84	6	50	5,5
H-B 24 SGRLH-LB-K29 ZW.		70163400	2	29	120	138	136,5	132	144	43	45	57,8	84	6	50	5,5
H-B 24 SGRH-LB 21 ZW.	70160200		1	21	120	138	136,5	132	144	43	45	57,8	84	6	50	5,5
H-B 24 SGRH-LB 29 ZW.	70160400		1	29	120	138	136,5	132	144	43	45	57,8	84	6	50	5,5
H-B 24 SGRH-LB-K 21 ZW.		70162200	1	21	120	138	136,5	132	144	43	45	57,8	84	6	50	5,5
H-B 24 SGRH-LB-K 29 ZW.		70162400	1	29	120	138	136,5	132	144	43	45	57,8	84	6	50	5,5
H-B 48 SGRL 29 ZW.	10166000		2	29	132	152	139,5	111	132	90	106	120	100	12	105	6,5
H-B 48 SGRL 36 ZW.	10166100		2	36	132	152	139,5	111	132	90	106	120	100	12	105	6,5
H-B 48 SGR 29 ZW.	10165000		1	29	132	152	139,5	111	132	90	106	120	100	12	105	6,5
H-B 48 SGR 36 ZW.	10165100		1	36	132	152	139,5	111	132	90	106	120	100	12	105	6,5

A

C

L

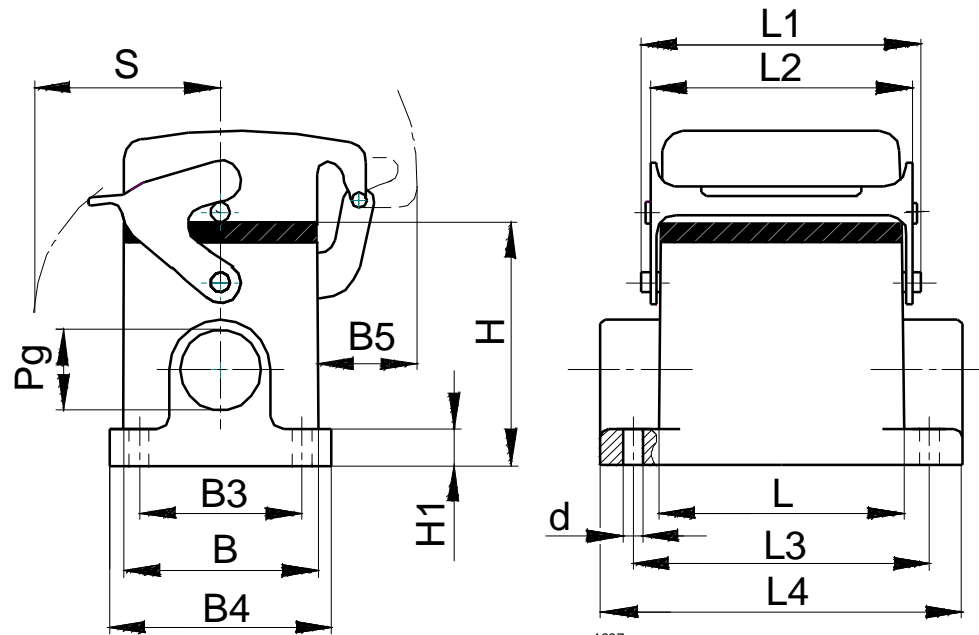

1997 07.11. Suchy

Sockelgehäuse
mit LB und Deckel

KBG-0180-00

01 - - - -

A

C

L

Benennung Description Désignation	Art. Nr. part No. N° art.	Art. Nr. part No. N° art.	Kabel Eingang Cable entry sortie	PG	L	L1	L2	L3	L4	B	B3	B4	B5	H	H1	S	d
H-B 6 SDRL 16 ZW.	10009000		2	16	60	74,8	70	70	84	43	40	54	25	54	4	44	5,5
H-B 6 SDRL-K 16 ZW.		70018000	2	16	60	74,8	70	70	84	43	40	54	25	54	4,5	44	5,5
H-B 6 SDR 16 ZW.	10007000		1	16	60	74,8	70	70	84	43	40	54	25	54	4,5	44	5,5
H-B 6 SDR-K 16 ZW.		70017000	1	16	60	74,8	70	70	84	43	40	54	25	54	4,5	44	5,5
H-B 6 SDHRL-LB 21 ZW.	70016200		2	21	60	74,8	70	70	84	43	45	58	25	74	6	44	5,5
H-B 6 SDHRL-LB 29 ZW.	70016400		2	29	60	74,8	70	70	84	43	45	58	25	74	6	44	5,5
H-B 6 SDHRL-LB-K 21 ZW.		70018200	2	21	60	74,8	70	70	84	43	45	58	25	74	6	44	5,5
H-B 6 SDHRL-LB-K 29 ZW.		70018400	2	29	60	74,8	70	70	84	43	45	58	25	74	6	44	5,5
H-B 6 SDHR-LB 21 ZW.	70015200		1	21	60	74,8	70	70	84	43	45	58	25	74	6	44	5,5
H-B 6 SDHR-LB 29 ZW.	70015400		1	29	60	74,8	70	70	84	43	45	58	25	74	6	44	5,5
H-B 6 SDHR-LB-K 21 ZW.		70017200	1	21	60	74,8	70	70	84	43	45	58	25	74	6	44	5,5
H-B 6 SDHR-LB-K 29 ZW.		70017400	1	29	60	74,8	70	70	84	43	45	58	25	74	6	44	5,5
H-B 10 SDRL-LB 16 ZW.	10038900		2	16	73	91	88,5	82	94	43	40	54	25	57	4,5	50	5,5
H-B 10 SDRL-LB-K 16 ZW.		70067000	2	16	73	91	88,5	82	94	43	40	54	25	57	4,5	50	5,5
H-B 10 SDR-LB 16 ZW.	10036900		1	16	73	91	88,5	82	94	43	40	54	25	57	4,5	50	5,5
H-B 10 SDR-LB-K 16 ZW.		70066000	1	16	73	91	88,5	82	94	43	40	54	25	57	4,5	50	5,5
H-B 10 SDRLH-LB 21 ZW.	70065200		2	21	73	91	88,5	82	97	43	45	58	25	74	6	50	5,5
H-B 10 SDRLH-LB 29 ZW.	70065400		2	29	73	91	88,5	82	97	43	45	58	25	74	6	50	5,5
H-B 10 SDRLH-LB-K 21 ZW.		70067200	2	21	73	91	88,5	82	97	43	45	58	25	74	6	50	5,5
H-B 10 SDRLH-LB-K 29 ZW.		70067400	2	29	73	91	88,5	82	97	43	45	58	25	74	6	50	5,5
H-B 10 SDRH-LB 21 ZW.	70064200		1	21	73	91	88,5	82	97	43	45	58	25	74	6	50	5,5
H-B 10 SDRH-LB 29 ZW.	70064400		1	29	73	91	88,5	82	97	43	45	58	25	74	6	50	5,5
H-B 10 SDRH-LB-K 21 ZW.		70066200	1	21	73	91	88,5	82	97	43	45	58	25	74	6	50	5,5
H-B 10 SDRH-LB-K 29 ZW.		70066400	1	29	73	91	88,5	82	97	43	45	58	25	74	6	50	5,5
H-B 16 SDRL-LB 21 ZW.	10078900		2	21	93	111	109,5	105	117	43	45	57	25	64	4,5	50	5,5
H-B 16 SDRL-LB-K 21 ZW.		70117000	2	21	93	111	109,5	105	117	43	45	57	25	64	4,5	50	5,5
H-B 16 SDR-LB 21 ZW.	10076900		1	21	93	111	109,5	105	117	43	45	57	25	64	4,5	50	5,5

A

C

L

Benennung Description Désignation	Art. Nr. part No. N° art.	Art. Nr. part No. N° art.	Kabel Eingang Cable entry sortie	PG	L	L1	L2	L3	L4	B	B3	B4	B5	H	H1	S	d
H-B 16 SDR-LB-K 21 ZW.		70116000	1	21	93	111	109,5	105	117	43	45	57	25	64	4,5	50	5,5
H-B 16 SDRLH-LB 21 ZW.	70115200		2	21	93,3	111	109,5	105	117	43	45	58	25	84	6	50	5,5
H-B 16 SDRLH-LB 29 ZW.	70115400		2	29	93,3	111	109,5	105	117	43	45	58	25	84	6	50	5,5
H-B 16 SDRLH-LB-K 21 ZW.		70117200	2	21	93,3	111	109,5	105	117	43	45	58	25	84	6	50	5,5
H-B 16 SDRLH-LB-K 29 ZW.		70117400	2	29	93,3	111	109,5	105	117	43	45	58	25	84	6	50	5,5
H-B 16 SDRH-LB 21 ZW.	70114200		1	21	93,3	111	109,5	105	117	43	45	58	25	84	6	50	5,5
H-B 16 SDRH-LB 29 ZW.	70114400		1	29	93,3	111	109,5	105	117	43	45	58	25	84	6	50	5,5
H-B 16 SDRH-LB-K 21 ZW.		70116200	1	21	93,3	111	109,5	105	117	43	45	58	25	84	6	50	5,5
H-B 16 SDRH-LB-K 29 ZW.		70116400	1	29	93,3	111	109,5	105	117	43	45	58	25	84	6	50	5,5
H-B 24 SDRL-LB 21 ZW.	10109900		2	21	120	138	136,5	132	144	43	45	57	25	64	4,5	50	5,5
H-B 24 SDRL-LB-K 21 ZW.		70167000	2	21	120	138	136,5	132	144	43	45	57	25	64	4,5	50	5,5
H-B 24 SDR-LB 21 ZW.	10107900		1	21	120	138	136,5	132	144	43	45	57	25	64	4,5	50	5,5
H-B 24 SDR-LB-K 21 ZW.		70166000	1	21	120	138	136,5	132	144	43	45	57	25	64	4,5	50	5,5
H-B 24 SDRLH-LB 21 ZW.	70165200		2	21	120	138	136,5	132	144	43	45	58	25	84	6	50	5,5
H-B 24 SDRLH-LB 29 ZW.	70165400		2	29	120	138	136,5	132	144	43	45	58	25	84	6	50	5,5
H-B 24 SDRLH-LB-K 21 ZW.		70167200	2	21	120	138	136,5	132	144	43	45	58	25	84	6	50	5,5
H-B 24 SDRLH-LB-K29 ZW.		70167400	2	29	120	138	136,5	132	144	43	45	58	25	84	6	50	5,5
H-B 24 SDRH-LB 21 ZW.	70164200		1	21	120	138	136,5	132	144	43	45	58	25	84	6	50	5,5
H-B 24 SDRH-LB 29 ZW.	70164400		1	29	120	138	136,5	132	144	43	45	58	25	84	6	50	5,5
H-B 24 SDRH-LB-K 21 ZW.		70166200	1	21	120	138	136,5	132	144	43	45	58	25	84	6	50	5,5
H-B 24 SDRH-LB-K 29 ZW.		70166400	1	29	120	138	136,5	132	144	43	45	58	25	84	6	50	5,5
H-B 48 SDRL 29 ZW.	10168000		2	29	132	152	139,5	111	132	90	106	120	30	100	12	105	6,5
H-B 48 SDRL 36 ZW.	10168100		2	36	132	152	139,5	111	132	90	106	120	30	100	12	105	6,5
H-B 48 SDR 29 ZW.	10167000		1	29	132	152	139,5	111	132	90	106	120	30	100	12	105	6,5
H-B 48 SDR 36 ZW.	10167100		1	36	132	152	139,5	111	132	90	106	120	30	100	12	105	6,5

A

C

L

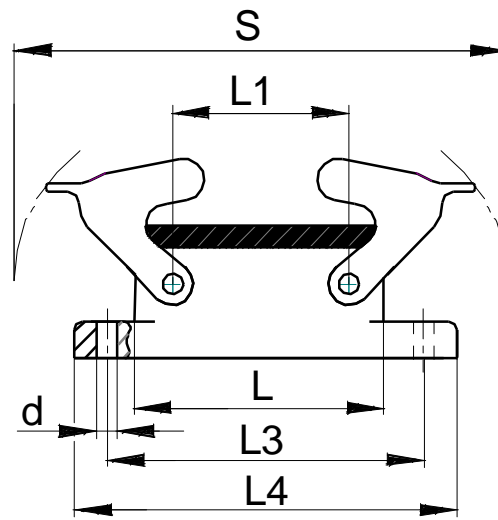
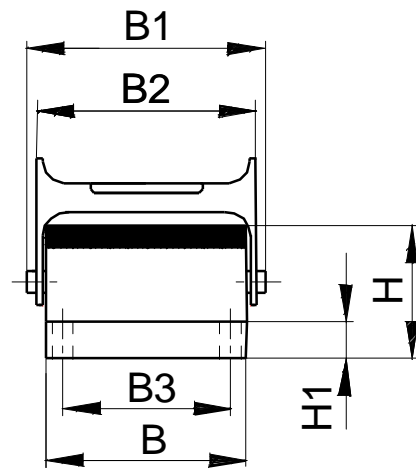

1997
28.10. Suchy

Anbaugehäuse
mit QB

KBG-0190-00

01 - - - -

A

C

L

Benennung	Art. Nr.	Art. Nr.	L	L1	L3	L4	B	B1	B2	B3	H	H1	S	d
Description	part No.	part No.												
Désignation	N° art.	N° art.												
H-B 10 AG	10032000		73	27	83	93	43	57,8	53	32	27,8	4	116	4,3
H-B 10 AG-K		70032500	73	27	83	93	43	57,8	53	32	27,8	4	116	4,3
H-B 16 AG	10072000		93,3	47,5	103	113	43	57,8	53	32	27,8	4	136,5	4,3
H-B 16 AG-K		70082500	93,3	47,5	103	113	43	57,8	53	32	27,8	4	136,5	4,3
H-B 24 AG	10102000		120	74	130	140	43	57,8	53	32	27,8	4	163	4,3
H-B 24 AG-K		70132500	120	74	130	140	43	57,8	53	32	27,8	4	163	4,3
H-B 32 AG	10132000		93,5	64,5	110	124	79	91	87,8	65	30,3	5	136,5	5,5

A

C

L

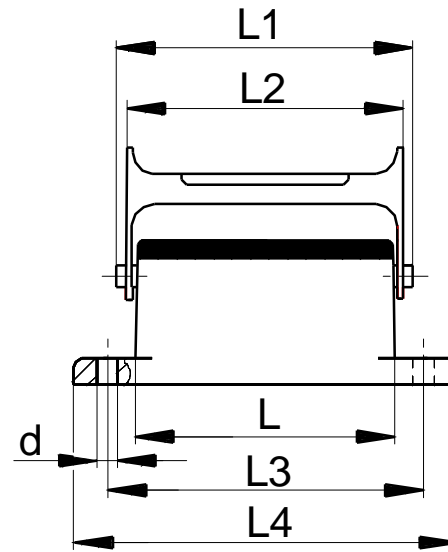
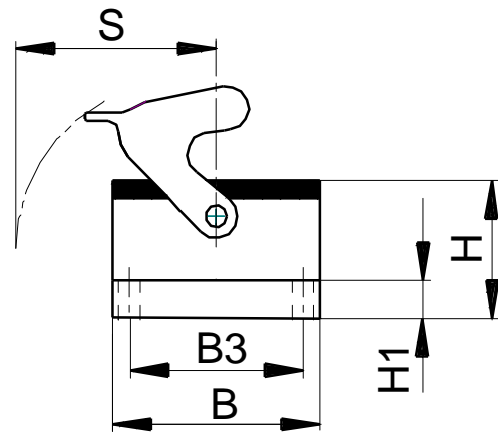

1997

Suchy

Anbaugehäuse
mit LB

KBG-0200-00

01

A

C

L

Benennung	Art. Nr.	Art. Nr.	L	L1	L2	L3	L4	B	B3	H	H1	S	d
Description	part No.	part No.											
Désignation	N° art.	N° art.											
H-B 6 AG	10003000		60	74,8	70	70	80	43	32	27,8	4	44	4,3
H-B 6 AG-K		70002500	60	74,8	70	70	80	43	32	27,8	4	44	4,3
H-B 10 AG-LB	10032900		73	91	88,5	83	93	43	32	27,8	4	50	4,3
H-B 10 AG-LB-K		70032700	73	91	88,5	83	93	43	32	27,8	4	50	4,3
H-B 16 AG-LB	10072900		93,3	111	109,5	103	113	43	32	27,8	4	50	4,3
H-B 16 AG-LB-K		70082700	93,3	111	109,5	103	113	43	32	27,8	4	50	4,3
H-B 24 AG-LB	10102900		120	138	136,5	130	140	43	32	27,8	4	50	4,3
H-B 24 AG-LB-K		70132700	120	138	136,5	130	140	43	32	27,8	4	50	4,3
H-B 48 AG	10161000		132	152	139,5	148	165	90	70	39,5	10	105	7

A

C

L

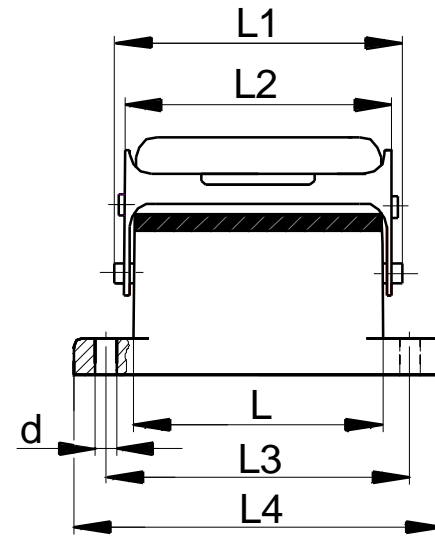
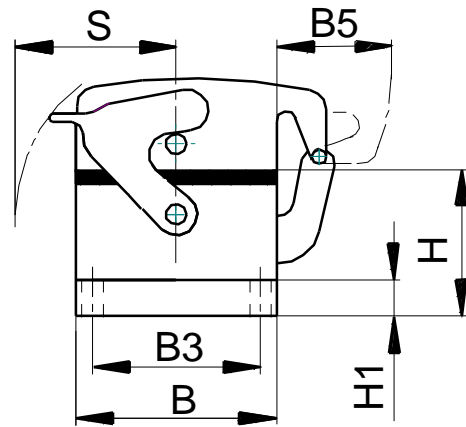

1997
07.11. Suchy

Anbaugehäuse
mit LB und Deckel
KBG-0210-00

01

A

C

L

Benennung	Art. Nr.	Art. Nr.	L	L1	L2	L3	L4	B	B3	B5	H	H1	S	d
Description	part No.	part No.												
Désignation	N° art.	N° art.												
H-B 6 AD	10004000		60	74,8	70	70	80	43	32	25	27,8	4	44	4,3
H-B 6 AD-K		70004500	60	74,8	70	70	80	43	32	25	27,8	4	44	4,3
H-B 10 AD-LB	10033900		73	91	88,5	83	93	43	32	25	27,8	4	50	4,3
H-B 10 AD-LB-K		70033700	73	91	88,5	83	93	43	32	25	27,8	4	50	4,3
H-B 16 AD-LB	10073900		93,3	111	109,5	103	113	43	32	25	27,8	4	50	4,3
H-B 16 AD-LB-K		70083700	93,3	111	109,5	103	113	43	32	25	27,8	4	50	4,3
H-B 24 AD-LB	10103900		120	138	136,5	130	140	43	32	25	27,8	4	50	4,3
H-B 24 AD-LB-K		70133700	120	138	136,5	130	140	43	32	25	27,8	4	50	4,3
H-B 48 AD	10152000		132	152	139,5	148	165	90	70	30	39,5	10	105	7

A

C

L

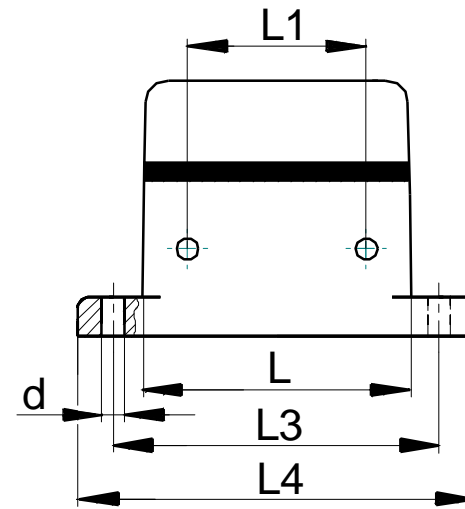
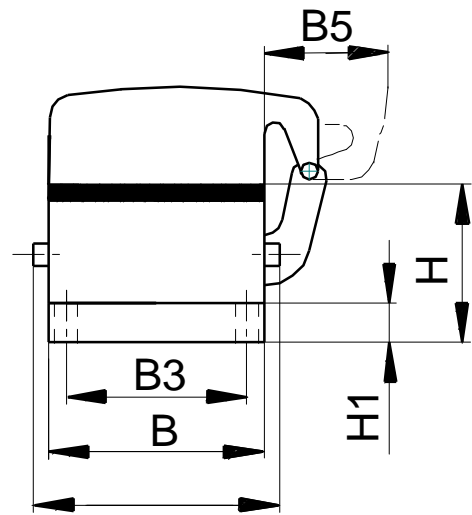

1997
07.11. Suchy

Anbaugehäuse
mit Deckel

KBG-0220-00

01 - - - -

A

C

L

Benennung	Art. Nr.	Art. Nr.	L	L1	L3	L4	B	B1	B3	B5	H	H1	d
Description	part No.	part No.											
Désignation	N° art.	N° art.											
H-B 10 AD-BO	10033000		73	27	83	93	43	57,8	32	25	27,8	4	4,3
H-B 10 AD-BO-K		70033500	73	27	83	93	43	57,8	32	25	27,8	4	4,3
H-B 16 AD-BO	10073000		93,3	47,5	103	113	43	57,8	32	25	27,8	4	4,3
H-B 16 AD-BO-K		70083500	93,3	47,5	103	113	43	57,8	32	25	27,8	4	4,3
H-B 24 AD-BO	10103000		120	74	130	140	43		32	25	27,8	4	4,3
H-B 24 AD-BO-K		70133500	120	74	130	140	43		32	25	27,8	4	4,3

A

C

L

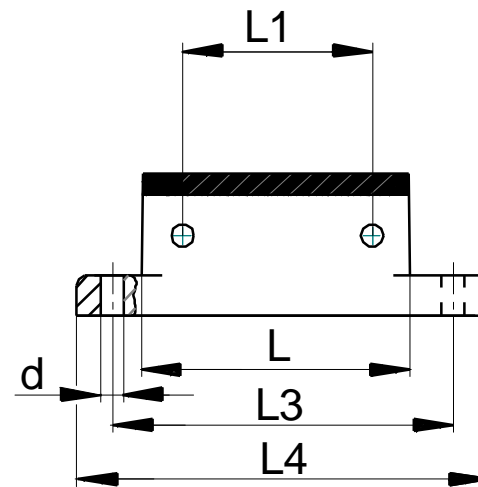
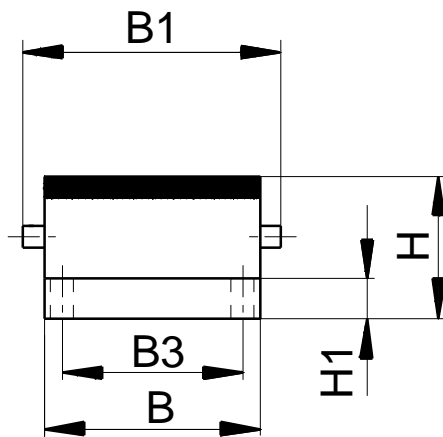

1997
28.10. Suchy

Anbaugehäuse

KBG-0225-00

01 -----

A

C

L

Benennung	Art. Nr.	Art. Nr.	L	L1	L3	L4	B	B1	B3	H	H1	d
Description	part No.	part No.										
Désignation	N° art.	N° art.										
H-B 32 AG-BO	10132300		93,5	64,5	110	124	79	89,5	65	30,3	5	5,5

CONTACT GmbH
 Gewerbestrasse 30
 70565 Stuttgart / Germany
 Tel. [+49] 711- 7838 03
 Fax [+49] 711- 7838 388
 Internet: www.contactconnectors.de
 eMail: contact@contactconnectors.de



1. By airplane

From Stuttgart airport, take the S-Bahn S2 or S3 train line to the Vaihingen train station (S-Bahnhof Vaihingen). From the platform, follow the underground passageway to the left (east side), approximately 200m to the bus stop (Bus 80). Ride Bus 80 to the DEKRA stop in Vaihingen industrial area. The Gewerbestrasse runs parallel to the bus line (Schulze-Delitzsch-Strasse). Walk back 100m and turn left at the next corner. Straight ahead and on the left hand side, you will see the Gewerbestrasse and our company.

2. By public transport

From the Stuttgart central train station (Hauptbahnhof Stuttgart), ride the S-Bahn train line S1, S2 or S3, leaving from the lower level train platform, to the Vaihingen train station (S-Bahnhof Vaihingen). From the platform, follow the underground passageway to the left (east side), approximately 200m to the bus stop (Bus 80). Ride Bus 80 to the DEKRA stop in Vaihingen industrial area. The Gewerbestrasse runs parallel to the bus line (Schulze-Delitzsch-Strasse). Walk back 100m and turn left at the next corner. Straight ahead and on the left hand side, you will see the Gewerbestrasse and our company.

3. By automobile

A8 Karlsruhe-München A8 München-Karlsruhe

Leave the Autobahn A8 at the exit 52a Vaihingen / Möhringen. Follow the road Nord-Sued-Strasse until you enter the Vaihingen industrial area. Look for the sign Möhringen. Turn left and after approximately 50m, turn left again. Follow the road passing the DEKRA building, which then enters the Schulz-Delitzsch-Strasse. Follow this road until the second corner, then turn left. Straight ahead and on the left hand side, you will see the Gewerbestrasse and our company.

4. By automobile from Stuttgart (downtown)

From the central train station (Hauptbahnhof Stuttgart) drive in the direction of the Staatsgalerie, turning right onto the B14 at the big intersection. Follow this road approximately 3000m to the Heslach-Tunnel (2000m). At the end of the tunnel, follow the left lane in the direction of Kaltental to Vaihingen (Stuttgart- Vaihingen). After reaching Schillerplatz, follow the left lane crossing the streetcar train tracks. Onto the Moehringer Landstrasse, continue until you see the street named Am Wallgraben which runs perpendicular. Turn right driving over the streetcar train tracks to the fourth street running perpendicular. Turn left onto the Schulze-Delitzsch-Strasse. At the second corner, turn right bringing you to the Gewerbestrasse. On the left hand side is our company.

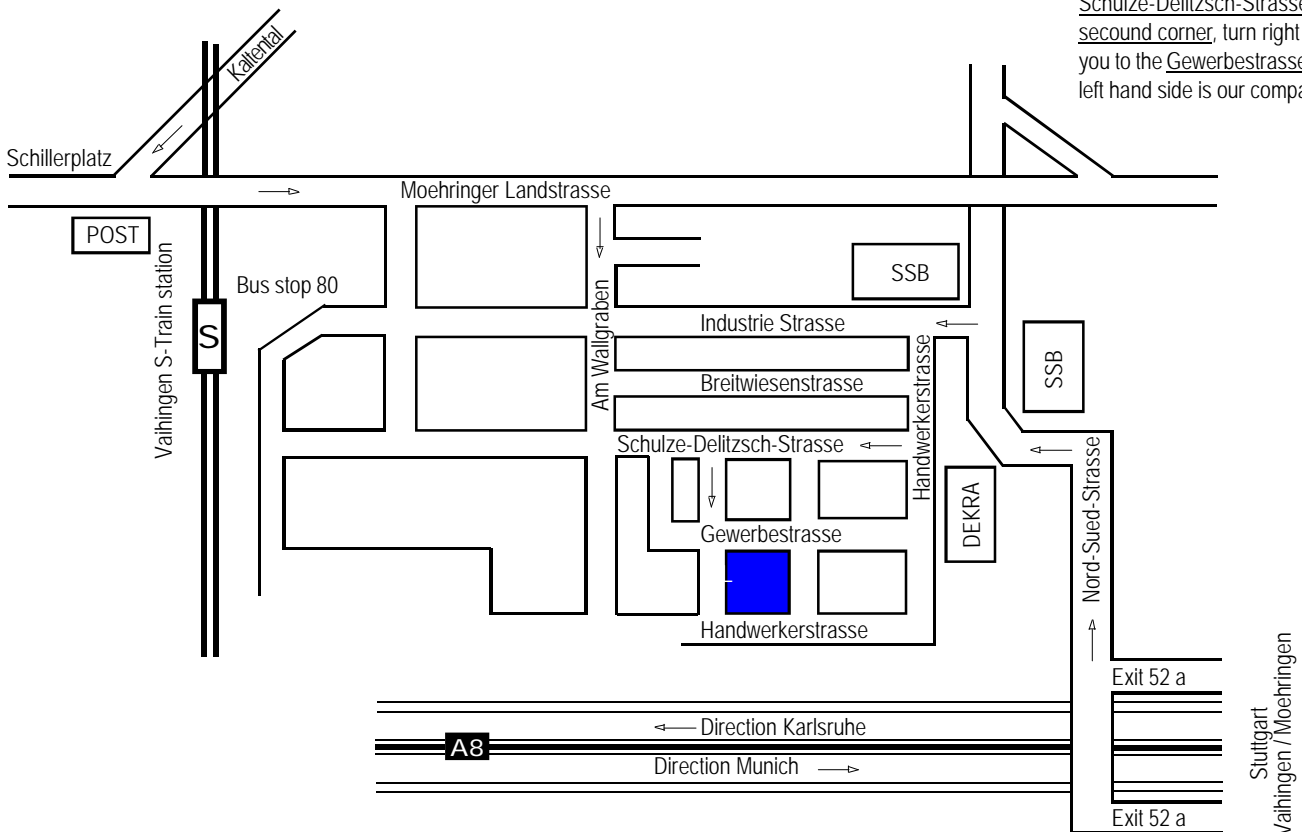

CONTACT GmbH
Gewerbstraße 30
D-70565 Stuttgart
Tel.: +49/711/78 38-03
Fax: +49/711/78 38-366 (D)
Fax: +49/711/78 38-388 (Export)
contact@contactconnectors.de
www.contactconnectors.de
Member of the LAPP GROUP